

Music & Paging Zone Mixer

QSC[®]

User Manual

MP-M80 Firmware Version 1.1

MP-M40 Firmware Version 1.1



TD-001578-01-B



EXPLANATION OF TERMS AND SYMBOLS

The term "**WARNING!**" indicates instructions regarding personal safety. If the instructions are not followed the result may be bodily injury or death.

The term "**CAUTION!**" indicates instructions regarding possible damage to physical equipment. If these instructions are not followed, it may result in damage to the equipment that may not be covered under the warranty.

The term "**IMPORTANT!**" indicates instructions or information that are vital to the successful completion of the procedure.

The term "**NOTE**" is used to indicate additional useful information.



The intent of the lightning flash with arrowhead symbol in a triangle is to alert the user to the presence of un-insulated "dangerous" voltage within the product's enclosure that may be of sufficient magnitude to constitute a risk of electric shock to humans.



The intent of the exclamation point within an equilateral triangle is to alert the user to the presence of important safety, and operating and maintenance instructions in this manual.



IMPORTANT SAFETY INSTRUCTIONS



1. Read these instructions.
2. Keep these instructions.
3. Heed all warnings.
4. Follow all instructions.
5. Do not use this apparatus near water.
6. Do not submerge the apparatus in water or liquids.
7. Do not use any aerosol spray, cleaner, disinfectant or fumigant on, near or into the apparatus.
8. Clean only with a dry cloth.
9. Do not block any ventilation opening. Install in accordance with the manufacturer's instructions.
10. Keep all ventilation openings free of dust or other matter.
11. Do not install near any heat sources such as radiators, heat registers, stoves, or other apparatus (including amplifiers) that produce heat.
12. To reduce the risk of electrical shock, the power cord shall be connected to a mains socket outlet with a protective earthing connection.
13. Do not defeat the safety purpose of the polarized or grounding-type plug. A polarized plug has two blades with one wider than the other. A grounding type plug has two blades and a third grounding prong. The wide blade or the third prong are provided for your safety. If the provided plug does not fit into your outlet, consult an electrician for replacement of the obsolete outlet.
14. Protect the power cord from being walked on or pinched particularly at plugs, convenience receptacles, and the point where they exit from the apparatus.
15. Do not unplug the unit by pulling on the cord, use the plug.
16. Only use attachments/accessories specified by the manufacturer.
17. Unplug this apparatus during lightning storms or when unused for long periods of time.
18. Refer all servicing to qualified service personnel. Servicing is required when the apparatus has been damaged in any way, such as power-supply cord or plug is damaged, liquid has been spilled or objects have fallen into the apparatus, the apparatus has been exposed to rain or moisture, does not operate normally, or has been dropped.
19. The appliance coupler, or the AC Mains plug, is the AC mains disconnect device and shall remain readily accessible after installation.
20. Adhere to all applicable, local codes.
21. Consult a licensed, professional engineer when any doubt or questions arise regarding a physical equipment installation.
22. Inspect the apparatus, including the power supply for signs of external wear and tear or signs of damage. All damage to the apparatus should be immediately repaired by a QSC authorized service station or QSC International Distributor. Failure to perform necessary repairs could lead to additional damage or to safety hazards. Failure to perform necessary repairs voids the limited warranty and QSC is not responsible for any injury, harm or related damages arising from any failure to perform those repairs.

Maintenance and Repair



WARNING!: Advance technology, e.g., the use of modern materials and powerful electronics, requires specially adapted maintenance and repair methods. To avoid a danger of subsequent damage to the apparatus, injuries to persons and/or the creation of additional safety hazards, all maintenance or repair work on the apparatus should be performed only by a QSC authorized service station or an authorized QSC International Distributor. QSC is not responsible for any injury, harm or related damages arising from any failure of the customer, owner or user of the apparatus to facilitate those repairs.

FCC Statement



NOTE: This equipment has been tested and found to comply with the limits for a Class B digital device, pursuant to Part 15 of the FCC Rules.

These limits are designed to provide reasonable protection against harmful interference in a residential installation. This equipment generates, uses and can radiate radio frequency energy and, if not installed and used in accordance with the instructions, may cause harmful interference to radio communications. However, there is no guarantee that interference will not occur in a particular installation. If this equipment does cause harmful interference to radio or television reception, which can be determined by turning the equipment off and on, the user is encouraged to try to correct the interference by one or more of the following measures:

- Reorient or relocate the receiving antenna.
- Increase the separation between the equipment and receiver.
- Connect the equipment into an outlet on a circuit different from that to which the receiver is connected.
- Consult the dealer or an experienced radio/TV technician for help.

Warranty

For a copy of the QSC Limited Warranty, visit the QSC website at www.qsc.com

Para una copia de la Garantía Limitada de QSC, visite el sitio web de QSC, en www.qsc.com

Pour obtenir une copie de la garantie limitée de QSC, visitez le site de QSC à www.qsc.com

Besuchen Sie die Webseite von QSC (www.qsc.com) um eine Kopie der beschränkte Garantie von QSC zu erhalten.

如果您想要QSC有限保修的複印本, 請造訪QSC品的網站www.qsc.com

Для ознакомления с условиями ограниченной гарантии, посетите страницу компании QSC в интернете www.qsc.com

للحصول على نسخة من الضمان المحدود الخاص بـQSC، قم بزيارة الموقع الإلكتروني لشركة QSC للمنتجات الصوتية على www.qsc.com

Table of Contents

Maintenance and Repair	ii
FCC Statement	iii
RoHS STATEMENT	iii
Warranty	iv
Music & Paging Zone Mixer Reference	8
Getting Started	8
System Requirements	8
MP Install	8
MP Manage	8
MP-MFC Controllers	8
MP-M Hardware	9
Front Panel	9
Rear Panel	9
Specifications	10
MP Install	11
Control Panel	11
Input Channels	12
Input Channel – Block Diagrams	12
Mic/Line and Auto-Mixer	12
Line, USB, Music on Hold, Cue, Wireless Paging	12
Input Channels – Home Screen	13
Input Channel – Navigation & Master Controls	14
Input Channel – Setup	15
Input Channel – Overview	16
Input Channel – Presets	17
Factory Presets	17
User Presets	18
Input Channel – PEQ	19
Input Channel – Dynamics	20
Compressor	20
Automatic Gain Control (AGC)	21
Input Channel – Gate	22
Input Channel – USB Player Setup	23
Input Channel – USB Player Overview	24
Input Channel – USB Player	25
Input Channel – USB Player PEQ	26
Input Channel – USB Dynamics Automatic Gain Control (AGC)	27

Output Zones	28
Output Zone – Block Diagrams	28
Mono Zone	28
Stereo (Linked) Zone	28
Output Zone – Home Screen	29
Output Zone – Navigation & Master Controls	30
Output Zone – Setup / Delay	31
Output Zone – Music on Hold	32
Output Zone – Overview	33
Output Zone – Sources	34
Output Zone – Presets	35
Factory Loudspeaker Library	35
User Presets	36
Filters & PEQ	37
Output Zone – Graphic Equalizer (GEQ)	38
Output Zone – Anti-Feedback	39
Output Zone – Loudness	40
Output Zone – Limiter	41
Mixer	42
Mixer Main – Block Diagram	42
Mixer Main – Home Screen	42
Mixer Main – PEQ	43
Mixer – FX Channel	44
Mixer – FX Effect	44
Mixer – FX Presets	44
Mixer – FX Shelf EQ	45
Setup Wizard	46
Menu	47
Menu – Home Screen	47
Menu – Configurations	48
Managing Configurations - Online	48
Managing Configurations – Offline	49
Configuration Files and Windows	49
Common Workflow Scenarios	49
Menu – Scenes	51
Menu – Scheduling	52
Menu – Controllers	53
Menu – Smartphone	54
Menu – GPI Setup	55
Menu – Report	56

Menu – System Test	57
Menu – Network	58
USB Wi-Fi Adapters	58
Network Help Button.....	58
Connecting to a Facility’s Network	58
Menu – Wired Network Setup: Auto IP Address	59
Menu – Wired Network Setup: Static IP Address	60
Menu – Wireless Network Setup: Create New Network	61
Menu – Wireless Network Setup: Connect to Existing Network.....	62
Menu – Security	63
Staff Access Management.....	63
Reset Passwords	63
Menu – Settings	64
Multi-Function Controller	65
Setup (Refer to Menu – Controllers.)	65
Operation	65
MP Manage	66
MP Manage – Security	66
Log in as Manager.....	66
Add a New User.....	66
MP Manage – Home Screen	67
MP Manage – Zone Overview	68
MP Manage – Zone Edit	68
MP Manage – Scheduler	69
To Modify an Event (New or Existing)	69
MP Manage – Scenes	70
MP Manage – Player	70
MP Manage – Mixer	71
MP Manage – Paging	72
MP-M Dimensions	61
MP-M Block Diagrams	64
Mic/Line Input Channels & Auto Mixer	64
Line Inputs, USB Inputs, Music on Hold, Cue, Wireless Paging	65
Mono Zone Output	66
Stereo (Linked) Zone Outputs	67
Mixer	68

Music & Paging Zone Mixer Reference

The information provided in this section gives you a detailed description of the screens and controls for the Music & Paging Zone Mixer and the Music & Paging Zone Mixer remote apps.

Getting Started

The QSC MP-M music and paging mixers are fixed architecture mixer/processors offering unprecedented capabilities combined with ease of configuration and operation. The products are intended for retail and hospitality applications in which high-quality audio from various sources is routed to multiple zones. Live mixing functions are also supported for applications requiring reinforcement of entertainment, presentations or conferences.

System Requirements

The MP-M Apps support:

- Android – 5.0 or later
- iOS – 8.0 or later
- macOS – 10.9 or later
- Windows – 10

MP Install

This app (for iOS / Android tablets, Windows and Mac OS) allows system designers and installers to quickly and easily design and configure systems for MP-M Series mixers. This wireless control features an intuitive Workflow Wizard to navigate through room tuning and speed commissioning.



MP Manage

For wireless control, the MP Manage app (for iOS / Android tablets and smartphones) provides end users day-to-day operation of basic system functions including zone level, source selection, scene recall, scheduling, and mixer control. It also offer a unique store-and-forward zone paging functionality to the MP-M Series mixer.



MP-MFC Controllers

The MP-MFC Controllers are intuitive wall mount controls to enable customizable system adjustments for the MP-M Series music and paging mixer. They provide multi-zone source selection, scene selection and volume control. Designers can configure these peripherals to provide end users with as much or as little control over the system as needed.



MP-M Hardware

Front Panel



NOTE: MP-M80 is shown.

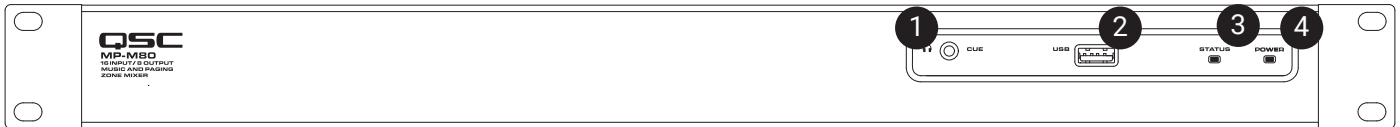

1. **CUE** – Headphones, 3.5 mm, stereo
2. **USB** – USB-A (rear panel – 1, front panel – 1), firmware & configuration uploads, USB Wi-Fi

3. **STATUS** –

Action	Appearance	Definition
Off		OK
On		Booting
Slow Blink		Firmware Upgrade
SOS Blink		Upgrade Failure

4. **POWER** –
- | | |
|----|-----|
| | |
| On | Off |

Rear Panel



NOTE: MP-M80 is shown.

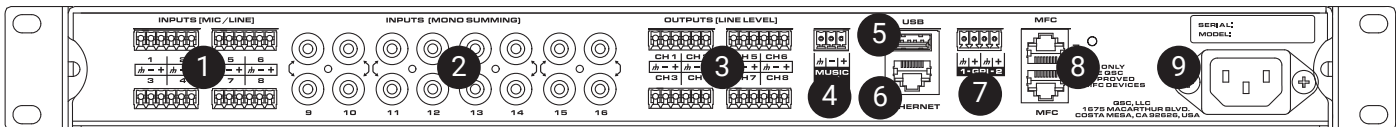

1. **INPUTS (MIC/LINE)** – Mic / Line Inputs, balanced, 12 V Phantom power, MP-M80 has 8 inputs, MP-M40 has 4 inputs, 6-pin Euroblock connectors
2. **INPUTS (MONO SUMMING)** – RCA Pairs, summed to mono, MP-M80 has 8 pairs, MP-M40 has 4 pairs
3. **OUTPUTS (LINE LEVEL)** – Balanced, Line Level, MP-M80 has 8 line level outputs, MP-M40 has 4 line level outputs, 6-pin Euroblock connectors
4. **MUSIC ON HOLD** – Transformer-balanced, 3-pin Euroblock connector
5. **USB** – USB-A (rear panel – 1, front panel – 1), firmware & configuration uploads, USB Wi-Fi
6. **Ethernet** – RJ45 For connecting to a network, wired and/or wireless.
7. **GPI** – 2 Inputs, Euroblock
8. **MFC** – MP-MFC ports, up to 4 MFC's per connection, 2 RJ45 connectors
9. **AC Mains** – power connection, 100-240 V, ~85 W, 50/60 Hz



CAUTION!: If AC power is removed, wait for 5 seconds before reapplying the AC power.

Specifications

Model	MP-M40	MP-M80
Inputs		
Total	8	16
Mic/Line	4 (Euroblock)	8 (Euroblock)
RCA	4 (mono-summed RCA pairs)	8 (mono-summed RCA pairs)
Outputs		
Total	6	10
Line	4 (Euroblock, balanced)	8 (Euroblock, balanced)
Music-on-Hold	1 (Euroblock, transformer balanced)	1 (Euroblock, transformer balanced)
Cue (phones)	1 (3.5 mm, stereo)	1 (3.5 mm, stereo)
Audio		
Sampling frequency	48 kHz	
Processing	32-bit floating point	
THD	<0.005%, +4 dBu and -2 dB; 20 Hz-20 kHz, unity gain, any input to any output	
Frequency response	20 Hz-20 kHz +/-0.5 dB, mic/line or line input to any line output	
Dynamic range	>106 dB unweighted	
Crosstalk	>90 dB typical, >80 dB max	
Gain (mic inputs)	51 dB	
Maximum input level	+24 dBu (mic/line inputs), +10dBV (line inputs)	
Maximum output level	+21 dBu (line-level outputs), +10dBV (Music on Hold)	
Phantom power	All microphone inputs (+12 volts)	
Latency	2.3 msec	
Input Processing		
EQ	4-band parametric EQ with high/low shelving option, variable 24 dB/octave HPF and LPF	
Dynamics	Gate, choice of Auto Gain Control (AGC) or compressor	
Output Processing		
EQ	1/3 octave GEQ	
Anti-feedback filters	12-band variable notch filters	
Dynamics	Comp/limiter, ducker, loudness	
Delay	100 msec	
Loudspeaker tunings	Factory: Intrinsic Correction™ voicing for QSC loudspeakers User: 6-band parametric EQ, HPF & LPF (Linkwitz-Riley or Butterworth; 12, 18 or 24 dB/octave)	
Control Accessories		
MP-MFC	Optional wall controller	
MP Install	For configuration/design functions (for iOS/Android tablets, Windows and Mac OS PCs),	
MP Manage	For end user control functions (for iOS/Android tablets and smartphones)	
Other Connections		
Ethernet	1 x RJ45 for connection to Wi-Fi router (user supplied)	
MP-MFC ports	2 x RJ45	
USB	2 USB-A (firmware & configuration uploads, USB Wi-Fi)	
GPI	2 inputs (Euroblock)	
Power requirements	100-240VAC, 50-60 Hz, universal supply, IEC inlet	
Indicators	Blue POWER LED, blue STATUS LED	
Dimensions (Net)	1.75 in x 19 in x 14 in (4.5 cm X 48.3 cm X 35.6 cm)	
Weight		
Shipping	11.0 lb (5.0 kg)	
Net	7.0 lb (3.2 kg)	

Specifications are subject to change without notice.

MP Install

MP Install is an app that runs on iOS, Android and Windows. It is intended for use by system designers and installers. See the Network section of this document for instructions on logging in to a new MP-M for the first time.

Control Panel

The Control Panel (right side of screen) provides navigation to all mixer controls, indicators and functions.

Navigational Controls

1. **Inputs** – Opens a screen that displays icons representing the controls and processing blocks for input channels.
2. **Outputs** – Opens a screen that displays the icons representing the controls and processing blocks for output channels.
3. **Mixer** – Opens the MP-M built-in mixer screen.
4. **Setup Wizard** – Opens a screen that provides a checklist of setup tasks and links to areas of the mixer where the tasks are performed.
5. **Menu** – Opens a screen providing access to the setup functions for the system.

Operational Controls

6. **Cue Level** button – Opens the Cue Level pop-up.
7. **Copy** and **Paste** buttons – The MP-M has a powerful but simple copy and paste function. Copy and Paste is context sensitive so what you are looking at is what will be copied. Only “like” things can be copied and pasted from and to each other. For example, a PEQ cannot be pasted to a GEQ. Some screens cannot be copied, for example the Inputs Home screen. In these cases a dialog displays saying “Copy not available here”.
8. **Prev** ◀ & **Next** ▶ buttons – Navigate to the next or previous channel.
9. **Nudge** up ^ & down v buttons – Increases or decreases the value setting of the selected control.
10. **Zero** ∅ button – Returns the selected control to its factory default value.
11. **Fine** ⚙ button – Decreases the amount of change that will be applied by the Nudge buttons.
12. **Cue Level** fader – Touch and drag to adjust the level of audio from the Cue output jack.
13. Cue Level **Close** button – Touch to close the Cue fader pop-up.

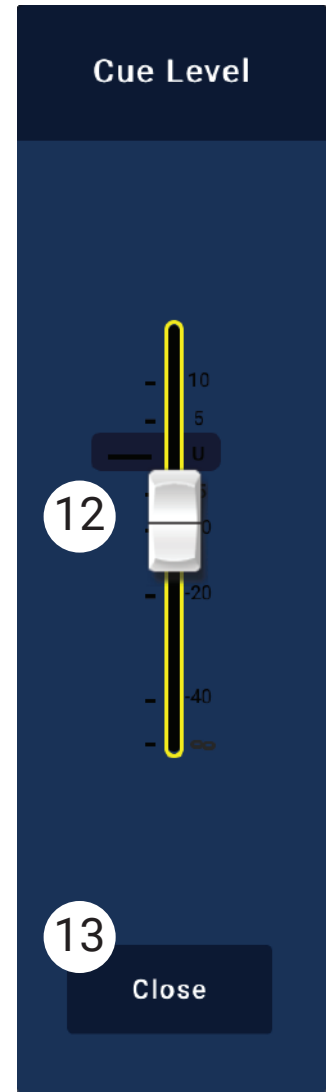
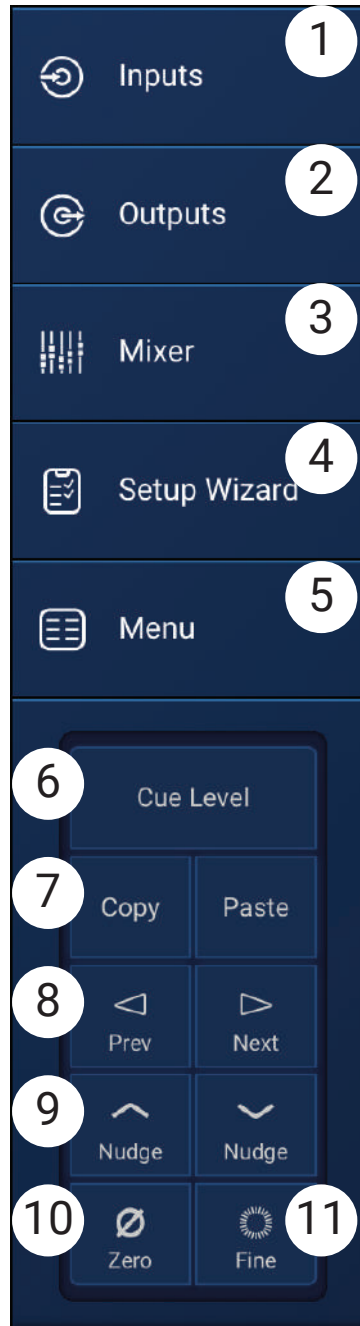

Input Channels

Input Channels Block Diagrams

Mic/Line Input Channels and Auto-Mixer

MP-M40: 1 of 4 Mic/Line Inputs / MP-M80: 1 of 8 Mic/Line Inputs

Touch Inputs

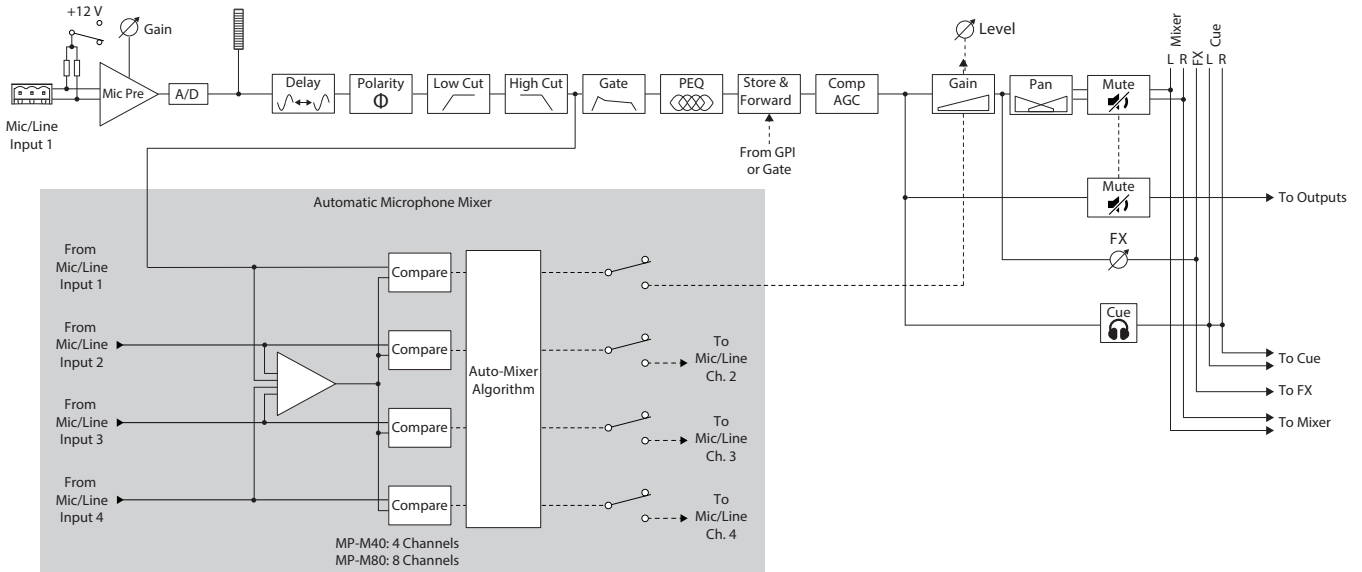

Line Inputs, USB Inputs, Music on Hold, Cue, Wireless Paging

MP-M40: 1 of 4 Mic/Line Inputs / MP-M80: 1 of 8 Mic/Line Inputs

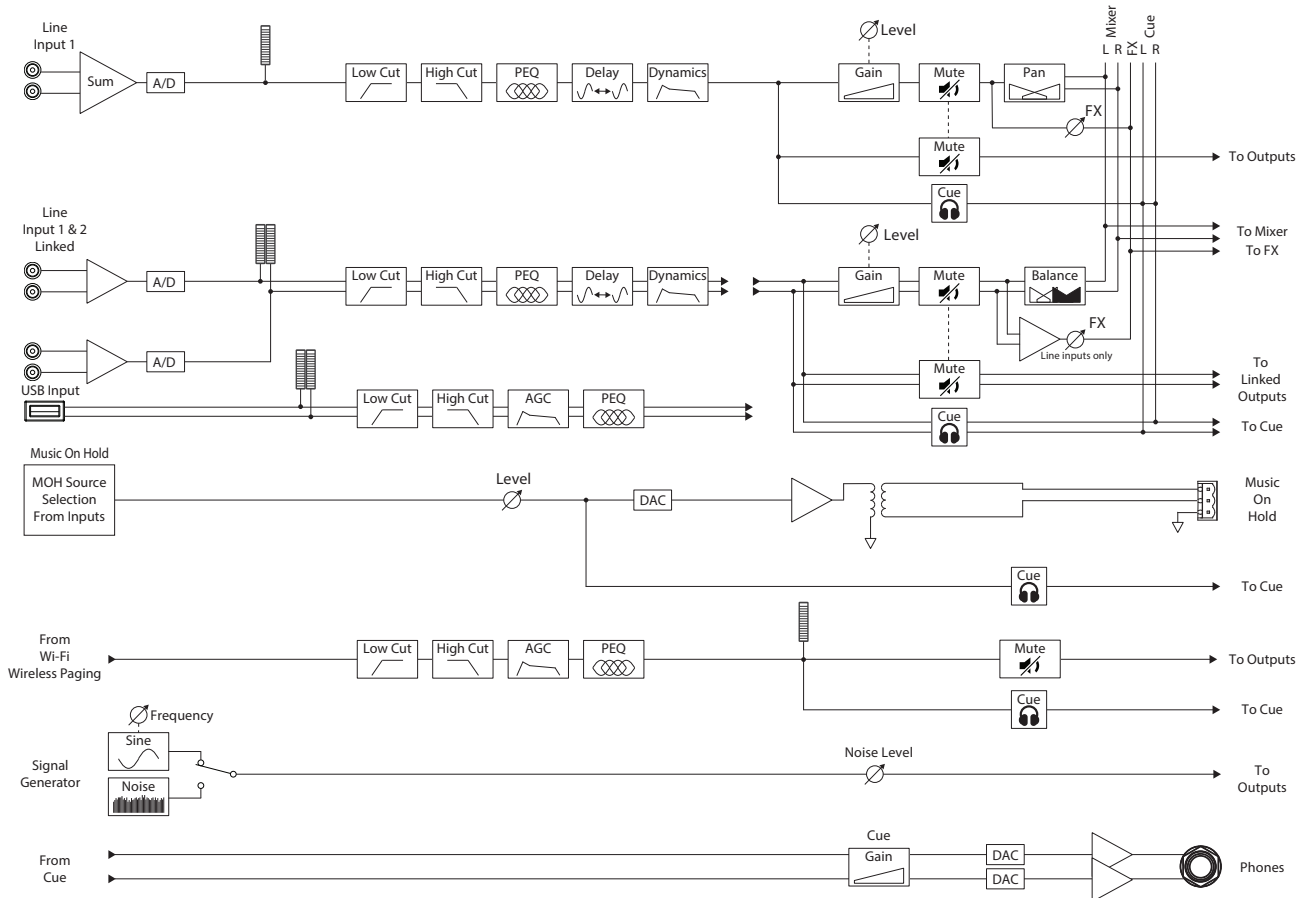

Input Channels – Home Screen

Touch Inputs



The Inputs home screen displays a high-level overview of the channels in a channel bank along with links to the various control groups, Setup, PEQ, Dynamics, and so on.

1. Channel Banks (MP-M80 Shown) – Select from channels
 - **Mic/Line** – Displays Mic/Line input processing blocks.
 - **RCA** – Displays processing blocks for the mono-summed RCA inputs.
 - **More** – Displays processing blocks for the USB Player and Wi-Fi paging.
2. **Setup** – Touch to access Input Name, Channel Safe, Stereo Link, Reset and Delay.
3. **Overview** – Touch to access Overview screen. The Inputs screen displays:
 - a. Channel number
 - b. Name
 - c. Level meter
 - d. **C** – Cue status light color indicates the Cue is active, dark color indicates the Cue is inactive.
 - e. **M** – Mute status Red indicates the channel is muted, dark color indicates channel is not muted.
4. Type of Input – Mic/Line or Mono Summed
5. **Presets** – Touch to access the Presets screen to access recall, reset, save / save as, Factory and User presets, and more.
6. **PEQ** – Dark button indicates the PEQ is not engaged, light button indicates the PEQ is engaged. Touch the button to access the PEQ screen where all PEQ parameters and engaging / disengaging the PEQ can be accessed.
7. **Dynamics** – The Dynamics consists of a Compressor and an AGC. A dark button indicates the Compressor / AGC is not engaged, light button indicates the Dynamics are engaged. Touch the button to access the Dynamics screen where switching between the AGC or Compressor, and modifying all parameters and engaging / disengaging the Dynamics can be accomplished.
8. **Gate** – Dark button indicates the Gate is not engaged, light button indicates the Gate is engaged. Touch the button to access the Gate screen where you can modify all Gate parameters and engage / disengage the Gate.



Input Channel – Navigation and Master Controls

Input channels are the audio source for all Output Zones and for the MP-M Internal Mixer. All controls on the input channels affect the Mixer and the Output Zones with the exception of the Fader, Pan and Auto-Mix which affect only the Mixer. When an Input Channel is selected the following controls and indicators are available

Input Channel Navigation Controls

The icons at the top of the screen are used to navigate the channel processing blocks. Refer to the individual topics for details of the following:

1. **Setup** – The Setup screen provides controls to change the channel name, input trim, and various other functions.
2. **Overview** – The Overview screen displays and provides controls for most of the parameters associated with a channel.
3. **Presets** – The Presets screen provides controls to recall, save, and manage presets.
4. **PEQ** – The Parametric EQ screen provides controls to adjust the parametric EQ for the channel.
5. **Dynamics** – The Dynamics screen provides the option to select the Compressor or AGC (Automatic Gain Control), and the controls to adjust either.
6. **Gate** – The Gate screen provides controls to setup and make adjustments to the Gate.
7. **Prev / Next** – Navigates to the next or previous channel. The buttons cycle through the Input, Line In, and FX channel, then loops back to Input 1.

Input Channel Master Controls

8. **Channel** label – Displays the name as entered in the Setup screen's Input Name field.
9. **Cue** – Sends the pre-fader channel signal to the Cue headphone output.
10. **Channel Type and Number** – Displays the type of channel (Mic, Stereo, Playback, Record, FX) and its number. This cannot be changed.
11. **G** – Indicates that the Gate for the channel is engaged or not.
12. **C** – Indicates that the Dynamic processing (Compressor or AGC) for the channel in engaged or not.
13. **P** – Indicates that Phantom power for the channel is engaged or not.
14. **Meter** – Indicates the channel signal level. This meter is Pre-fader.
15. **Mute** – Mutes the channel going to the zones and to the MP-M internal mixer.



NOTE: The MP-M includes an internal mixer. The following controls adjust the channel's signal in the mixer only and have no effect on the channel signal that is sent to the zones.

16. **Fader** – Adjusts the level of the channel's signal in the MP-M internal mixer.
17. **Pan** – Adjusts the Left/Right balance of the channel in the MP-M internal mixer.
18. **Auto-Mix** (microphone inputs only) – Applies the Auto-Mixer (see the Mixer Section topic) to the channel.

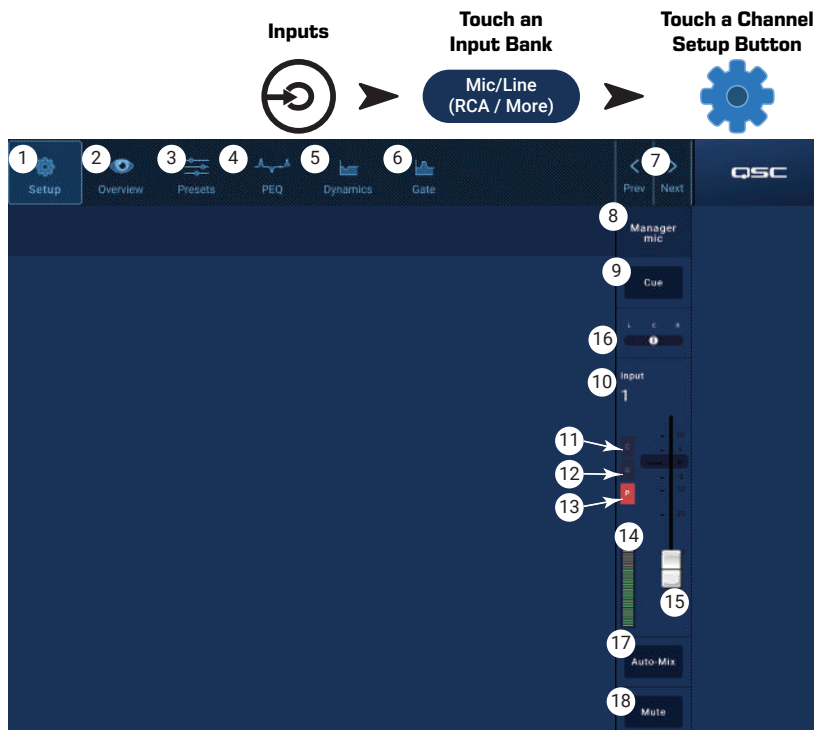

Input Channel – Setup

The setup screen includes a number of functions that are primarily “set once and forget”. Channel Setup is provided for all input channels.

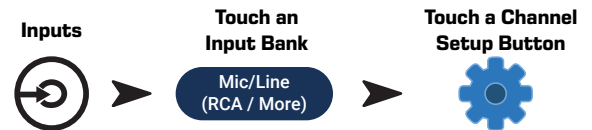

1. **Setup** button – Selects the Setup screen.
2. **Stereo Link** button – Links / unlinks adjacent channels for stereo operation. The odd numbered channel settings are copied to the even numbered channel. Pan settings are mirrored. Only odd/even linking is supported (1-2, 3-4, etc.). Even/odd linking (2-3, 4-5) is not available.
3. **Reset** button – Returns all Setup settings, for this channel, to default values.
4. **Input Name** field – Displays the name of the channel. Touch to display a keyboard and rename the channel with a “friendly name”. Use only upper and lower case alpha characters.
5. **Polarity** switch – Inverts the polarity of the input signal.
6. **Channel Safe During Scene Recall** switch – When set to Safe, the channel will not be affected by a scene recall.
7. **Input Trim** knob – Adjusts the input sensitivity for the Mic/Line channels. Not available on the USB Player or Wifi Paging.
8. **Phantom Power** switch – Turns phantom power on or off for the channel (Mic/Line input channels only). (available on MP-M80 channels 1-8 and on MP-M40 channels 1-4)
9. **Video Sync Delay** slider – Video Sync Delay allows the audio to be delayed by up to 100 milliseconds. The delay value is also displayed in feet and meters. This feature is typically used to compensate for “lip flap” which occurs when the latency of a video signal is greater than that of the accompanying audio.
10. **Delay Enable** switch – Engages or disengages the Video Sync Delay.



Input Channel – Overview

The Input Overview screen displays an at-a-glance view of the settings for the selected input. Most controls on this screen also appear on other input screens.

To copy all the settings for an input, touch the Copy button while this screen is displayed. To paste the settings to another input, navigate to the target input and touch Paste.

The following items are available on the Input Channel Overview screen.

1. **Navigation** icons – Touch an icon to navigate to the associated Input Channel processing block. (See topics for details.)
2. **Preset** button – Displays the currently active input preset. Touch the field to navigate to the Presets processing block to recall or manage presets. This field is not available on the USB Player or WiFi channels. (See topic for details.)
3. **Reset** button – Touch to reset all Input Channel controls to the factory default setting.
4. **Input Trim** knob – Adjusts the input sensitivity for the Mic/Line channels. Not available on the USB Player or Wifi Paging.
5. **Stereo Link** button – Links adjacent, odd/even channels for stereo operation. Not available on the USB Player or WiFi channels.
6. **Phantom Power** switch – Turns phantom power on or off for the channel (Mic/Line input channels only). (available on MP-M80 channels 1-8 and on MP-M40 channels 1-4)
7. **Polarity** switch – Reverses the polarity for the channel signal. Available on Mic/Line input channels only.
8. **Gate** – Available controls on this screen are: In, Threshold, Attack, Release, Attenuation, and Hold. Select a control and use the Nudge buttons to change values. Not available on the USB Player or WiFi channels. (See topic for details.)
9. **Delay** knob and **Enable** button – Adjusts delay and enables / disables the delay. Not available on the USB Player or WiFi channels.
10. **PEQ** – Available controls on this screen are: In, HPF, LPF, Gain, and Frequency. Select a control and use the Nudge buttons to change values. (See topic for details.)
11. **Comp** and **AGC** –
 - a. Available controls for the Compressor on this screen are: In, Thresh, Attack, Release, Ratio, and Gain. Select a control and use the Nudge buttons to change values. (See topic for details.)
 - b. Available controls for the AGC on this screen are: In, Max Target, Min Target, Max Gain, Threshold, and Release. Select a control and use the Nudge buttons to change values. (See topic for details.)

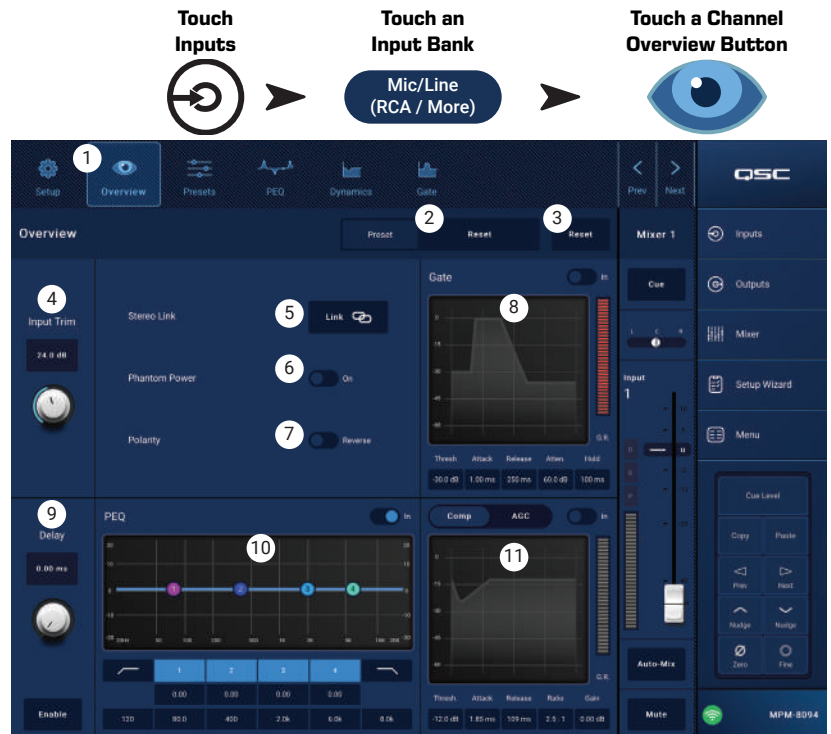

Input Channel – Presets

The MP-M includes presets for speech and musical instruments. The musical instrument presets are intended for applications in which the Mixer section is used for reinforcement of live entertainment.

An Input Channel Preset consists of settings for the channel EQ, dynamics and gate that can be saved and recalled. The channel name and level settings are also stored with the preset but may be omitted from a preset recall by setting the Recall Omits switches to omit them.

Factory Presets

1. **Presets** button – Displays the Presets screen.
2. **Preset Info** button – Touch to displays a pop-up message with details about the current Preset. Touch OK on the pop-up to close.
3. **Current Preset** field – Displays the name of the currently active preset.
4. **Factory / User** switch – For this topic, set the switch to Factory. Selects between the internal factory presets or user presets. Refer to the User Presets topic for details.
5. **Recall Omits** – Allows selected parameters to be unaffected by a preset recall. The parameters that can be selected are: **Levels**, **Name**, **12V** phantom power. The parameter is selected when the switch is “on”.
6. **Recall** button – Touch to recall the preset selected in the Selection windows.
7. **Selection windows** – These windows (**Input**, **Type**, and **Preset Name**) are used to select a preset for recall.

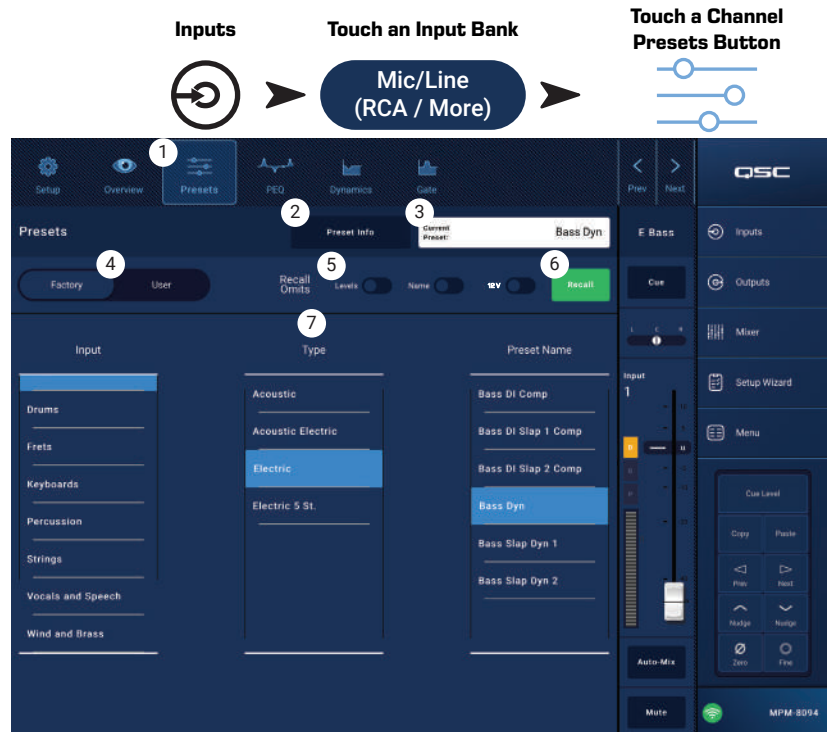

User Presets

The User Preset screen is where custom user tunings and presets are stored and managed.

1. **Presets** button – Displays the Presets screen.
2. **Save / Save as** button – Touch to display a pop-up message with details about the current Preset. Touch OK on the pop-up to close.



TIP: If a Factory Preset is recalled, it can then be saved as a user preset. This can be used as a start on which to build custom presets.

- a. **Save Preset As** field – touch the field to access a keyboard and enter a different name for the preset or, leave the name as it is, and continue to the next step.
 - b. **Storage Location** switch – Select either MP-M Internal (on the mixer), or USB attached to the mixer.
 - c. **Save** button – Touch the button to save the preset in the selected location.
 - d. **Cancel** button – Touch the button to exit the dialog without saving the preset.
3. **Current Preset** field – Displays the name of the currently active preset.
 4. **Factory / User** switch – Selects between the internal factory presets or user presets. User presets may be stored and recalled to and from the MP-M internal memory or an attached USB storage device.
 5. **Recall Omits** – Allows selected parameters to be unaffected by a preset recall. The parameters that can be selected are: Levels, Name, 12V Phantom power. The parameter is selected when the switch is “on”.
 6. **Recall** button – Touch to recall the preset selected in either the MP-M Internal, or the USB External list.
 7. **Selection windows** – These windows (App Storage, MP-M Internal, and USB External) are used to select a preset for recall and to copy presets from one location to another.
 8. **App Storage** list - Displays any user presets stored in the internal memory of the device being used to control the MP-M. When this panel is selected, the Copy to MP-M button will copy the preset to MP-M internal memory. You cannot Recall a preset from App Storage. To Recall, save the preset to MP-M Internal, then Recall.
 9. **MP-M Internal** list – Displays any user presets stored in the MP-M internal memory. When this panel is selected, the selected Preset can be copied to either the App Storage or USB External. In addition, the Preset can be recalled, then be saved or saved as a different preset.
 10. **USB External** list – Displays any user presets stored on a connected USB device. When this panel is selected, the selected Preset can be copied to the MP-M Internal storage. In addition, the Preset can be recalled, then can be saved or saved as a different preset.
- One item in the App Storage list, MP-M Internal list, or the USB External list must be selected for the following controls to be available.
11. **Copy To MP-M** button – Touch to copy a selected preset from the App Storage to the MP-M Internal storage.
 12. **Copy to USB** button – Touch to copy a selected preset from the MP-M Internal storage to the USB storage.
 13. **Copy To App** button – Touch to copy a selected preset from the MP-M Internal storage to the App Storage.
 14. **Copy to MP-M** button – Touch to copy a selected preset from the USB External storage to the MP-M Internal storage.
 15. **Delete** button – Deletes the selected preset.

Inputs



Touch an Input Bank

Mic/Line
(RCA / More)

Touch a Channel Presets Button

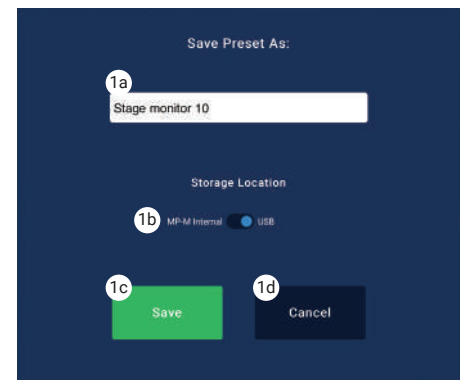
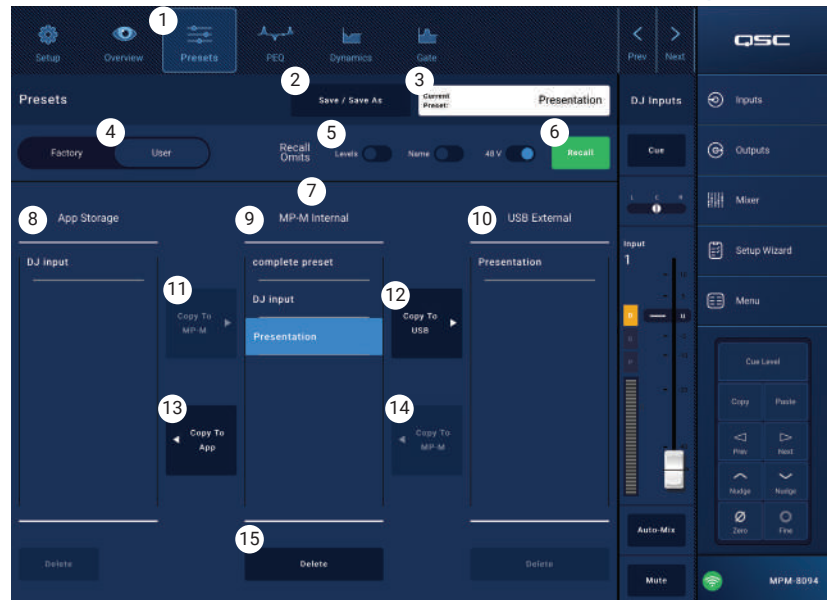

Input Channel – PEQ

This screen controls and displays the settings for the Input Channel parametric equalization.

The PEQ is a 4-band, fully parametric EQ that includes variable HPF (High Pass Filter) & LPF (Low Pass Filter).

- The HPF is variable with a range of 20 Hz to 2,000 Hz. It passes frequencies above the setting while cutting those below.
- The LPF is variable with a range of 1 kHz to 20 kHz. It passes frequencies below the setting while cutting those above.
- Bands 1 and 4 may be configured as shelving filters.

1. **PEQ** tab – Selects the EQ screen.
2. **PEQ Out/In** – Engages / disengages the equalizer.
3. **RTA On** – Engages / disengages the a real time analyzer that displays the tonal balance of the channel's signal including peak hold indicators.



NOTE: Only one RTA may be running on the system at a time. Touch the RTA button. If another device is using the RTA, the message to the right displays.



NOTE: When the RTA is off, the Parametric EQ graph expands to use the entire graph area.

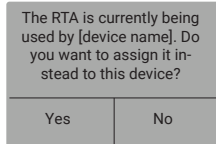
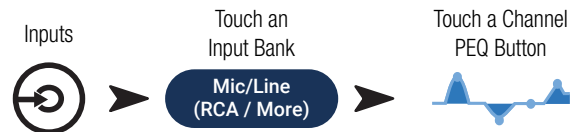

4. **Simple** button – Hides the Frequency, and Q controls for all bands and low and high cut filters. Changing to Simple mode does not affect existing settings.
5. **Reset** button – Sets all the PEQ controls to their factory default position.
6. **RTA** display – Displays the amplitude of the channel signal in 1/3 octave bands. Peak hold indicators are displayed for each band.
 - **RTA** graph vertical scale – Represents audio level from -60 dB to -5 dB.
 - **RTA** graph horizontal scale – Represents frequency from 31.5 Hz to 16 kHz.
7. **Parametric EQ** graph – A graphic representation of the equalization curve based on the PEQ settings. The trace dims to indicate that the PEQ is Out (disengaged).
 - **EQ** graph vertical scale – Represents audio level from -20 dB to +20 dB.
 - **EQ** graph horizontal scale – Represents frequency from 20 Hz to 20 kHz.
8. **EQ** handles – Touch, hold, and drag to change the Frequency and Gain of the associated PEQ band. The frequency band button must be engaged to see the handles.
9. **High Pass** and **Low Pass** buttons – Engages / disengages the HPF and LPF (described above).
10. **Low Shelf** and **High Shelf** filter buttons – Changes EQ Band 1 and Band 4 from parametric filters to shelving filters. When a shelf filter is engaged, the Q control is not available. The low shelving filter raises or lowers a range of frequencies below the set frequency. The high shelving filter raises or lowers a range of frequencies above the set frequency.
11. **Frequency Bands 1, 2, 3, and 4** buttons – Engages / disengages the associated parametric EQ band. Each band is fully parametric with a frequency range of 20 Hz to 20 kHz.
12. **Gain** control knob and readout – Adjusts the gain at the frequency setting of the associated EQ band. Range of -15 dB to +15 dB.
13. **Freq** control knob (Frequency bands 1 – 4) – Sets the center frequency of the associated EQ band. If the Shelving filter is engaged, the Freq control sets the knee frequency of the shelf filter.
14. **Q** knob – Adjusts the Q of the associated EQ band. When the Shelf Filter is selected, the Q control is hidden. In addition, Q can be adjusted by “pinching”.
15. **Freq control knob** (Low and High Cut) – Sets the frequency of the low and/or high cut filter as measured from a point 3 dB below 0 or unity.

Input Channel – Dynamics (Compressor / AGC)

The Input Channel Dynamics processing block may be configured as either a Compressor or an Automatic Gain Control (AGC).

Compressor

The Compressor controls the dynamic range of a signal above a set Threshold.

- Dynamics** button – Selects the Compressor / AGC screen.
- Compressor / AGC** button – Selects either Compressor or AGC.
- In** switch – Engages and disengages the Compressor or AGC processor.

- Knee In** button – Determines how abruptly or gradually the compressor transitions in and out of gain reduction as the threshold is crossed.

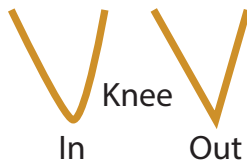

- Simple** button – Turns Simple mode on and off. When on, it hides all controls except:
 - Compressor / AGC
 - Comp In
 - Simple
 - Reset
 - Compression (Threshold)

All other controls remain at the value set prior to engaging the Simple mode button.

- Reset** button – Sets all the Compressor and AGC controls, for this channel, to their factory default position.
- Input** meter – Displays the RMS input signal level.
- Reduction** meter – The red display indicates how much the signal is being reduced by the compressor. This meter displays a signal regardless of whether the In button is engaged or not.
- Output** meter – Output level after any applied compression
- Compressor** graph – Vertical scale from 0 dB to -60 dB; horizontal measurement is time. When engaged, the trace displays.
 - Threshold (A)** – The level at which compression begins.
 - Attack** time (B to E) – The time it takes for the compression to reach its maximum compression after the input exceeds the threshold level.
 - Ratio (A to E)** – The amount of compression applied to the signal.
 - Release** time (C to D) – The time it takes for the compressed signal to rise to the threshold level once the input level no longer exceeds the threshold.
- Threshold** slider – Sets the point at which the compressor begins to reduce signal level.
- Attack** slider – Adjusts how quickly the compressor reacts to a signal that exceeds the threshold.
- Release** slider – Adjusts how quickly the compressor stops compressing when signal falls below threshold.
- Ratio** slider – Sets the ratio of input level change to output level change when the signal exceeds the threshold.
- Gain** slider – Adjusts the overall output gain to makeup any loss after the signal is compressed.
- Compressor in/out** indicator – When the Compressor (or AGC) is In, an orange “C” displays on the channel controls strip.

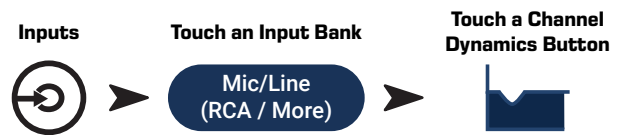

Automatic Gain Control (AGC)

The Automatic Gain Control is used to compensate for variations in the audio level of the source material.

1. **Dynamics** button – Selects the Compressor / AGC screen.
2. **Compressor / AGC** button – Selects either Compressor or AGC.
3. **In** switch – Engages and disengages the AGC processor.
4. **Reset** button – Sets all the Compressor and AGC controls, for this channel, to their factory default position.
5. **Input** meter – Displays the RMS input signal level
6. **Reduction** meter – Indicates how much the signal level has been altered by the AGC. The center (0 dB) indicates that no gain change is being applied. Rightward movement of the meter indicates that gain is being applied. Leftward movement indicates attenuation (reduction) of the signal level.
7. **Output** meter – Indicates the output signal level after AGC has been applied.

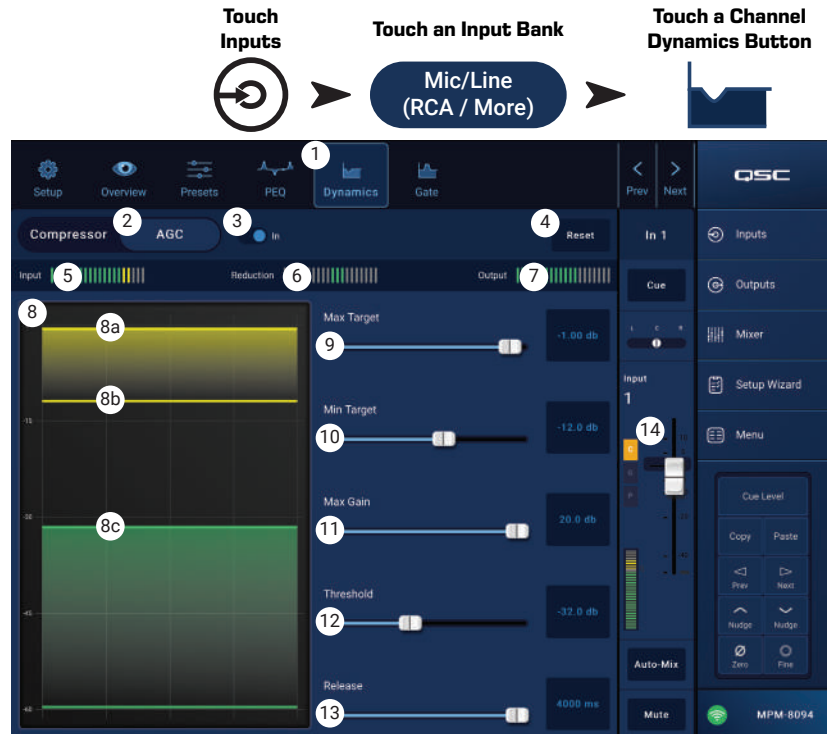

8. **AGC** graph – Vertical scale from 0 dB to -60 dB. When the AGC is engaged, the trace is displayed.
 - a. **Max Target** – Indicates the maximum level that the AGC will maintain.
 - b. **Min Target** – Indicates the minimum level that the AGC will attempt to maintain.
 - c. **Threshold** – Indicates the level at which the AGC becomes active / inactive.
9. **Max Target** slider – Sets the maximum level that the AGC will maintain.
10. **Min Target** slider – Sets the minimum level that the AGC will attempt to maintain.
11. **Max Gain** slider – Sets a limit on the amount of gain the AGC will apply regardless of the target settings.
12. **Threshold** slider – Sets the level at which the AGC becomes active / inactive. Signals that fall below the threshold level are assumed to be intentional silence and the AGC will apply no additional gain.
13. **Release** slider – Adjusts how long the AGC holds its gain change after the input signal level changes.
14. **AGC** in/out indicator – When the AGC (or Compressor) is In, an orange “C” displays on the channel controls strip.



NOTE: The AGC should not be used on microphone inputs if there is any possibility of feedback.

If the source device lacks an output volume control, use the input channel gain control to simulate low and high level playback. Use the Cue output and headphones to listen to the results of the AGC.

To Adjust the AGC

1. Using program material that is slightly greater in level than the desired maximum signal level, adjust the Max Target slider until the Reduction indicates a slight amount of gain reduction by moving to the left of center.
2. Using program material that is slightly lower in level than the desired minimum signal level, adjust the Min Target slider until the Reduction Meter indicates a slight amount of gain addition by moving to the right of center.
3. If some low-level passages of the program material are being boosted excessively, use the Max Gain control to decrease the maximum gain the AGC applies.
4. With no program material playing, adjust the Threshold so that the Reduction Meter shows no additional gain being applied. This adjustment prevents the AGC from applying full gain to residual noise from the sources when no signal is present.

Input Channel – Gate

The Gate passes audio above a set Threshold, and attenuates audio below the Threshold. In addition, the Gate is used as part of the Store & Forward paging function.

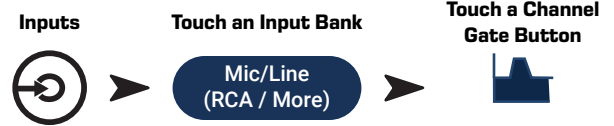

1. **Gate** button – Selects the Gate Screen.
2. **Gate In** switch – Engages or disengages the Gate.
3. **Simple** button – Turns Simple mode on and off. Hides all controls except:
 - Gate In button
 - Simple button
 - Reset button
 - Gating slider
4. **Reset** button – Sets all the Gate controls to their factory default position.
5. **In** meter – RMS input level
6. **G.R.** meter – Gain Reduction – indicates how much the signal is being reduced by the Gate.
7. **Out** meter – Output level
8. **Gate** graph – When the Gate is engaged, the trace turns green. Horizontal axis is time, vertical axis is level.
 - Threshold (A)
 - Attack time (A-B)
 - Release time (C-D)
 - Attenuation Level (E).
9. **Threshold** slider – Sets the point at which the Gate allows audio to pass.
10. **Attack** slider – Adjusts how quickly the gate reacts to a signal that exceeds the threshold.
11. **Release** slider – Adjusts how quickly the Gate attenuates the audio when signal falls below threshold.
12. **Attenuation** slider – Sets the amount of attenuation applied to the output when the signal is below the Threshold.
13. **Hold** slider – Sets the minimum time the Gate stays open once it is opened, and the length of time the Gate stays open after the input level drops below the Threshold.
14. **Gate in/out** indicator – When the Gate is In, a green “G” displays on the channel controls strip.



Input Channel – USB Player Setup

The setup screen includes a number of functions that are primarily “set once and forget”. Channel Setup is provided for all input channels.

1. **Setup** button – Selects the Setup screen
2. **Reset** button – Returns all Setup settings, for this channel, to default values.
3. **Input Name** field – Displays the name of the channel. Touch to display a keyboard and rename the channel with a “friendly name”. Use only upper and lower case alpha characters.
4. **Channel Safe During Scene Recall** switch – When set to Safe, the channel will not be affected by a scene recall.

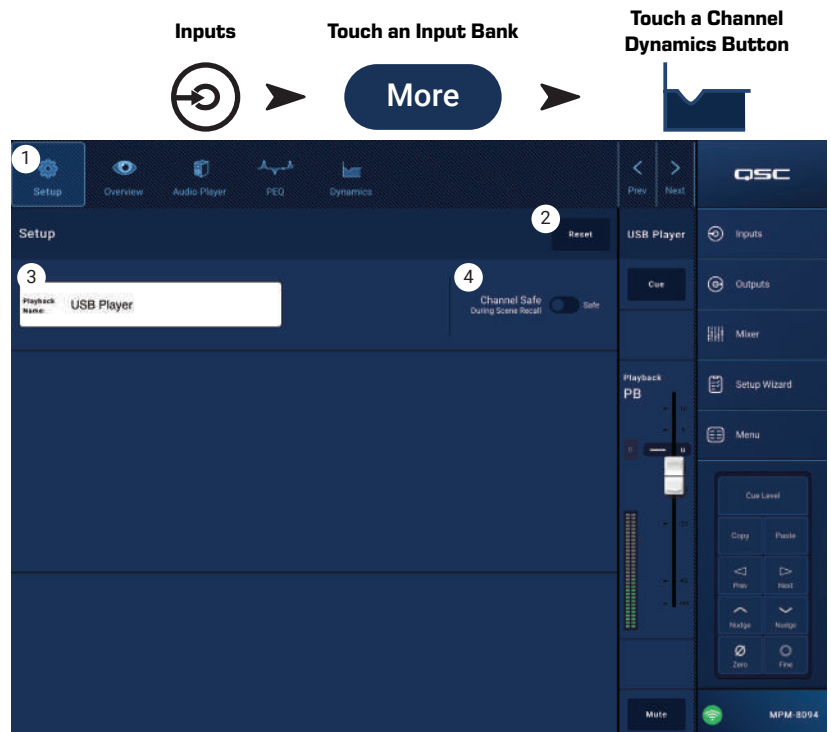

Input Channel – USB Player Overview

The Overview screen provides an abbreviated view of each section in the Input Channel USB Player function. Only the primary controls are available for adjustment in the overview.

1. **Overview** button – Selects the USB Player Overview screen.
2. **Reset** button – Sets all the PEQ controls to their factory default position.
3. **Digital Gain** knob – Compensates for digital audio files that are too low or high in level.

PEQ section

4. **Parametric EQ** graph – A graphic representation of the equalization curve based on the PEQ settings. The trace dims to indicate that the PEQ is Out (disengaged).
 - **EQ graph vertical scale** – Represents audio level from -20 dB to +20 dB.
 - **EQ Graph horizontal scale** – Represents frequency from 20 Hz to 20 kHz.
5. **EQ Out/In** – Engages / disengages the equalizer.
6. **EQ Handles** – Touch, hold, and drag to change the Frequency and Gain of the associated frequency band. The frequency band button must be engaged to see the handles.
7. **High Pass filter** button – Engages / disengages the high-pass filter. The HPF is variable with a range of 20 Hz to 2,000 Hz. It passes frequencies above the setting while cutting those below.
8. **Parametric Band 1 and 2** – Engages / disengages the associated parametric EQ band. Each band is fully parametric with a frequency range of 20 Hz to 20 kHz.
9. **Gain** control knobs and readouts – Adjusts the gain at the frequency setting of the associated filter. Range of -15 dB to +15 dB.
10. **Freq** control knob – Sets the frequency of the associated filter.

Dynamics Section (AGC)

AGC is used to compensate for variations in the audio level of the source material. **Refer to the AGC topic for complete details.**

11. **AGC** display – Graphically shows the relationship of the controls as they are set.
12. **AGC In** switch – Engages / disengages the AGC.
13. **Reduction** meter – Indicates how much the signal level has been altered by the AGC. The center (0 dB) indicates that no gain change is being applied. Rightward movement of the meter indicates that gain is being applied. Leftward movement indicates attenuation (reduction) of the signal level.



NOTE: Select a control then use the Nudge buttons to adjust.

14. **Max Target** control – Sets the maximum level that the AGC will maintain.
15. **Min Target** control – Sets the minimum level that the AGC will attempt to maintain.
16. **Max Gain** control – Sets a limit on the amount of gain the AGC will apply regardless of the target settings.
17. **AGC Threshold** control – Sets the level at which the AGC becomes active / inactive. Signals that fall below the threshold level are assumed to be intentional silence and the AGC will apply no additional gain.
18. **Release** control – Adjusts how long the AGC holds its gain change after the input signal level changes.

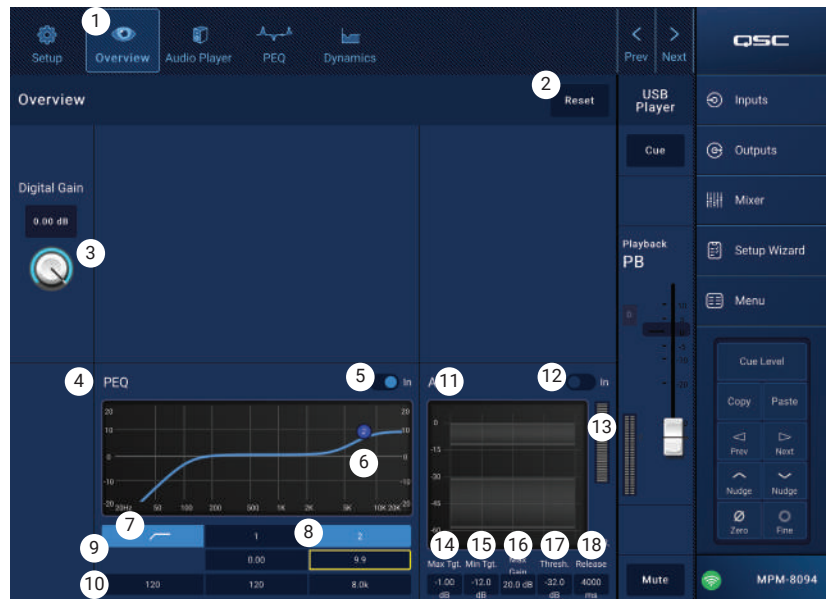

Input Channel – USB Player

Use the USB Player for MP3 playback from a USB storage device attached to one of the MP-M USB ports.

- The USB storage device must be formatted FAT32.
- The audio files must be in the root directory.
- Files are displayed in alpha-numeric order.
- MP3 files must have a sample rate of 44.1k.
- USB Playback must be enabled from Menu > Settings in order for this feature to be available for the MP Manage app.

1. **Audio Player** button – Selects the Audio Player screen.
2. **MP3 Songs** – Displays a list of MP3 titles on the inserted USB drive.
3. **Digital Trim** – Provides input gain control. (-12 dB to 0.00 dB)
4. **Playback Mode** –
 - **Normal** button – plays the files in listed order (alpha-numeric)
 - **Shuffle** button – plays the files in random order.
 - **Single** button – plays the selected file one time. Does not repeat.
5. **MP3** – Displays title of currently selected MP3 file.
6. Top-of-List (⏮) – Touch to move to the beginning of the file list.
7. Previous file (⏪) – Touch to move to the previous file in the file list.
8. Play (▶) – Touch to begin playback of the currently selected MP3 file.
9. Next file (⏩) – Touch to move to the next file in the file list.
10. Stop Play (⏹) – Touch to stop playback of the currently selected MP3 file.
11. Playback Time – Indicates elapsed time since beginning playback.
12. Progress Line indicates the approximate playback position in the file.
13. Position Progress (👉) – Touch, hold, and drag to desired position on the Progress Line.
14. 00:00:00 – Represents the start of the file.
15. HH:MM:SS – Indicates the length of the file.



Input Channel – USB Player PEQ

This screen controls and displays the settings for the Input Channel 2-Trk PB parametric equalization.

The PEQ is a 2-band, high / low shelving EQ that includes variable HPF (High Pass Filter).

The HPF cuts frequencies from 20 Hz to 2,000 Hz (low cut) and passes frequencies above 2,000 Hz (high pass).

1. **PEQ** button – Selects the EQ screen.
2. **EQ Out/In** – Engages / disengages the equalizer.
3. **RTA On** – Engages / disengages the a real time analyzer. The RTA displays the tonal balance of the channel's signal. Peak hold indicators are displayed for each band.



NOTE: Only one RTA may be running on the system at a time. Touch the RTA button. If another device is using the RTA, the message to the right displays.

The RTA is currently being used by [device name]. Do you want to assign it instead to this device?

Yes	No
-----	----



NOTE: When the RTA is off, the Parametric EQ graph expands to use the entire graph area.

4. **Reset** button – Sets all the PEQ controls to their factory default position.
5. **RTA** display – Displays the amplitude of the channel signal in 1/3 octave bands. Peak hold indicators are displayed for each band.
 - **RTA** graph vertical scale – Represents audio level from -60 dB to -5 dB.
 - **RTA** graph horizontal scale – Represents frequency from 31.5 Hz to 16 kHz.
6. **Parametric EQ** graph – A graphic representation of the equalization curve based on the PEQ settings. The trace dims to indicate that the PEQ is Out (disengaged).
 - **EQ** graph vertical scale – Represents audio level from -20 dB to +20 dB.
 - **EQ** Graph horizontal scale – Represents frequency from 20 Hz to 20 kHz.
7. **EQ** handles – Touch, hold, and drag to change the Frequency and Gain of the associated frequency band. The frequency band button must be engaged to see the handles.
8. **High Pass** filter button – Engages / disengages the HPF (described above).
9. **High Pass Freq** control knob – Sets the frequency of the high pass filter (20 Hz to 2,000 Hz). The frequency reading is taken at -3 dB.
10. **Low Shelf and High Shelf** filter buttons – Engages / disengages the low and high shelving filters. The low shelving filter raises or lowers a range of frequencies below the set frequency. The high shelving filter raises or lowers a range of frequencies above the set frequency.
11. **Gain** control knob and readout – Adjusts the gain at the frequency setting of the associated shelving filter. Range of -15 dB to +15 dB.
12. **Freq** control knob (Low and High Shelving) – Sets the frequency of the low / high shelving filter.

Input Channel – USB Dynamics Automatic Gain Control (AGC)

The Automatic Gain Control is used to compensate for variations in the audio level of the source material.



1. **Dynamics** button – Selects the AGC screen.
2. **AGC In** switch – Engages and disengages the AGC processor.
3. **Reset** button – Sets all the AGC controls, for this channel, to their factory default position.
4. **Input** meter – Displays the RMS input signal level
5. **Reduction** meter – Indicates how much the signal level has been altered by the AGC. The center (0 dB) indicates that no gain change is being applied. Rightward movement of the meter indicates that gain is being applied. Leftward movement indicates attenuation (reduction) of the signal level.
6. **Output** meter – Indicates the output signal level after AGC has been applied.
7. **AGC** graph – Vertical scale from 0 dB to -60 dB. When the AGC is engaged, the trace is displayed.
 - a. **Max Target** – Indicates the maximum level that the AGC will maintain.
 - b. **Min Target** – Indicates the minimum level that the AGC will attempt to maintain.
 - c. **Threshold** – Indicates the level at which the AGC becomes active / inactive.
8. **Max Target** slider – Sets the maximum level that the AGC will maintain.
9. **Min Target** slider – Sets the minimum level that the AGC will attempt to maintain.
10. **Max Gain** slider – Sets a limit on the amount of gain the AGC will apply regardless of the target settings.
11. **Threshold** slider – Sets the level at which the AGC becomes active / inactive. Signals that fall below the threshold level are assumed to be intentional silence and the AGC will apply no additional gain.
12. **Release** slider – Adjusts how long the AGC holds its gain change after the input signal level changes.
13. **AGC in/out** indicator – When the AGC is In, an orange “D” displays on the channel controls strip.



NOTE: The AGC should not be used on microphone inputs if there is any possibility of feedback.

If the source device lacks an output volume control, use the input channel gain control to simulate low and high level playback. Use the Cue output and headphones to listen to the results of the AGC.

To Adjust the AGC

1. Using program material that is slightly greater in level than the desired maximum signal level, adjust the Max Target slider until the Reduction indicates a slight amount of gain reduction by moving to the left of center.
2. Using program material that is slightly lower in level than the desired minimum signal level, adjust the Min Target slider until the Reduction Meter indicates a slight amount of gain addition by moving to the right of center.
3. If some low-level passages of the program material are being boosted excessively, use the Max Gain control to decrease the maximum gain the AGC applies.
4. With no program material playing, adjust the Threshold so that the Reduction Meter shows no additional gain being applied. This adjustment prevents the AGC from applying full gain to residual noise from the sources when no signal is present.

Output Zones

Touch Inputs



Output Zone – Block Diagrams

Mono Zone

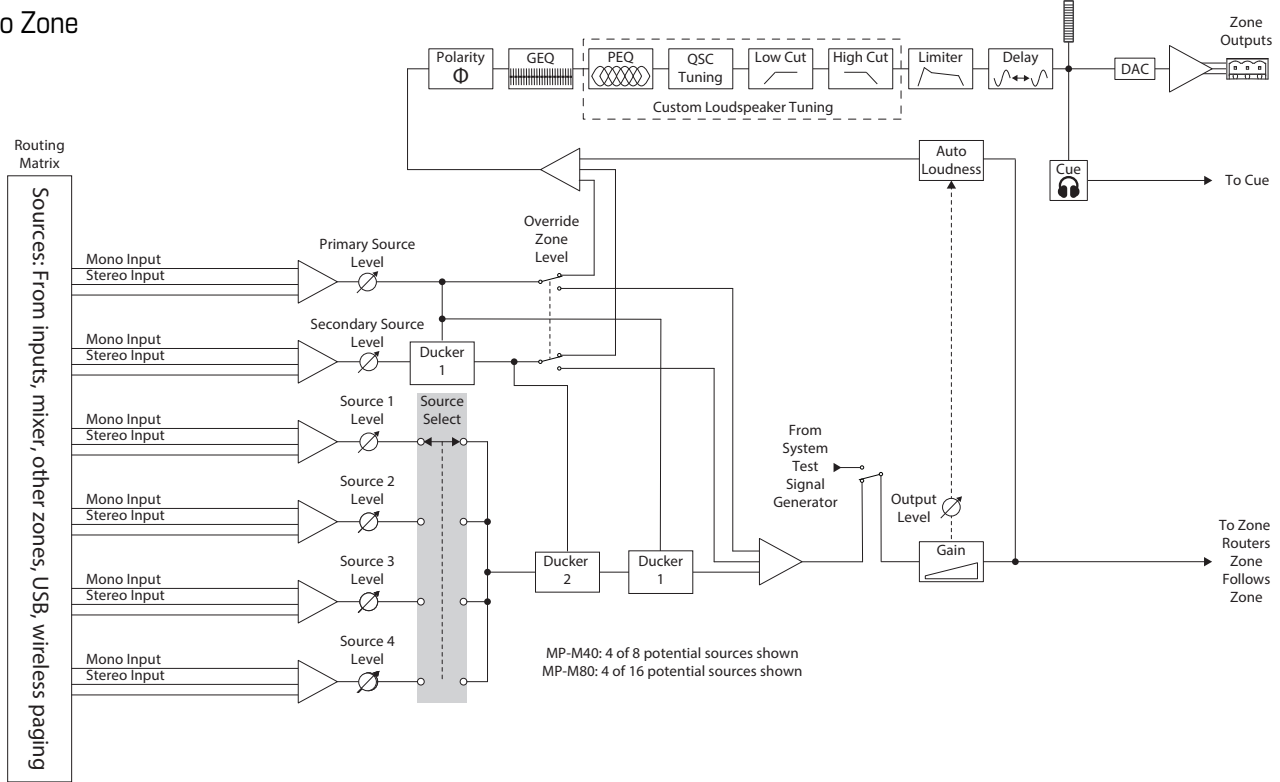

Stereo (Linked) Zone

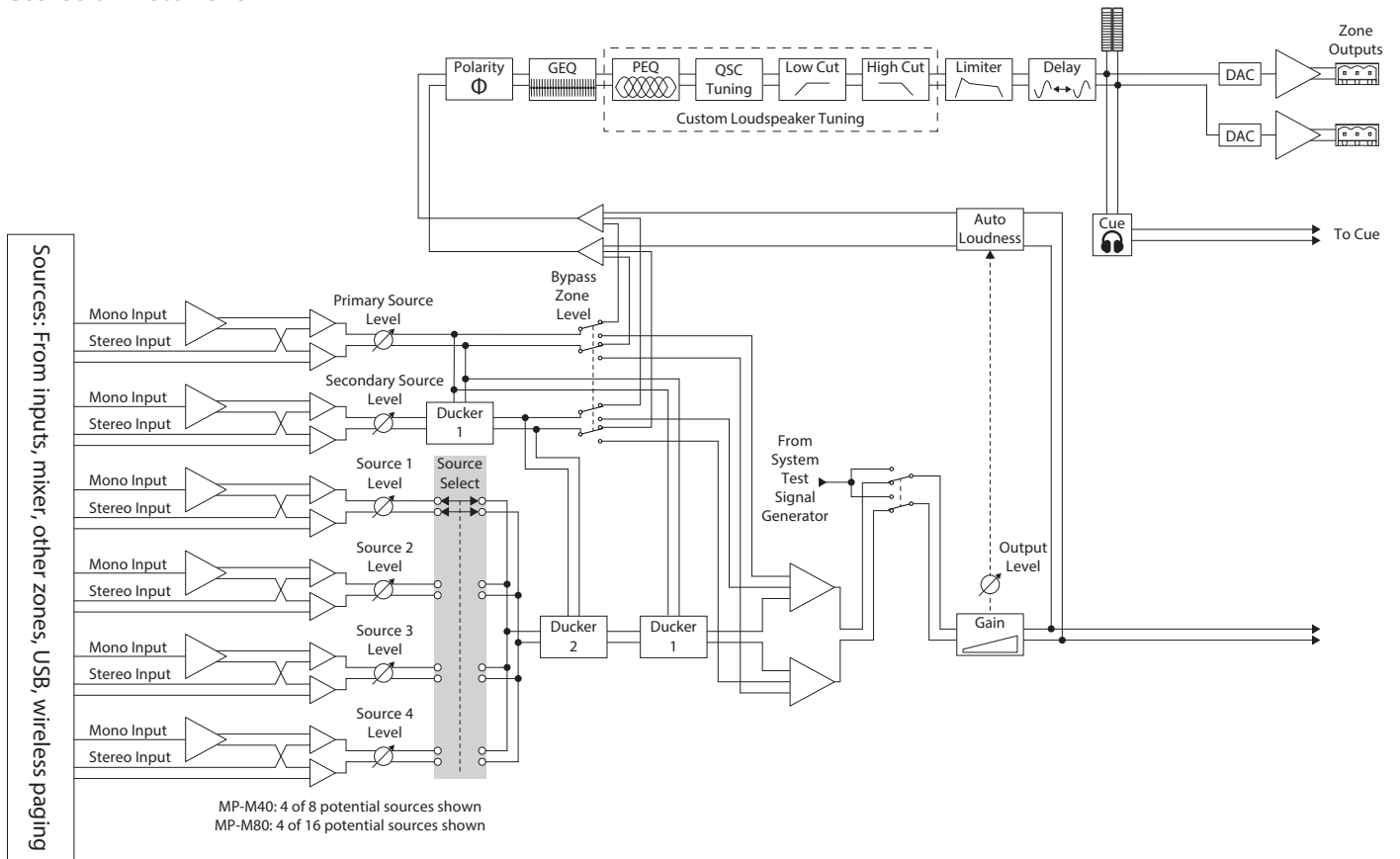

Output Zones – Home Screen

The Outputs Home screen displays the processing blocks for the output channels. Touch any block to see the associated controls and displays for the Output Zone processing block.

1. **Zones / Music on Hold** (MP-M80 shown) – Zones displays the Zones (output channels) and processing block for the corresponding Zones. Music on Hold displays the Music on Hold output channel and its processing blocks.
2. Titles for the processing block columns.
3. Linked stereo processing block.
4. Mono processing block.
5. Light-colored blocks (highlighted) indicate that the block is engaged.
6. Dark-colored blocks indicate that the block is not engaged.

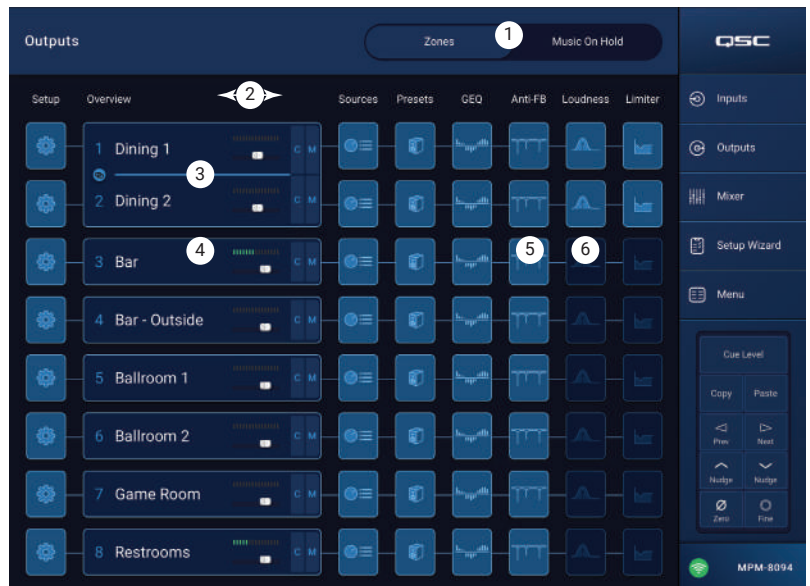

Output Zone – Navigation & Master Controls

Output Zone Navigation Icons

The icons at the top of the screen display when you select a channel. Use these to navigate to other processing blocks for the output channel. These icons remain visible when an output channel-processing block is selected.

1. **Setup** – The Setup screen provides controls to change the channel name, link channels, set Channel Safe and set the delay.
2. **Overview** – The Overview screen displays and provides controls for most of the settings for the selected channel.
3. **Sources** – The Sources screen provides controls to select the sources and their priority for the selected channel.
4. **Speakers** – The Speakers screen provides controls to select, recall, save custom settings, and sets which parameters of a preset to recall.
5. **GEQ** – The GEQ screen provides a 28 band GEQ and an RTA display.
6. **Anti FB** – The Anti-Feedback screen provides controls to set automatic anti-feedback, or manual kill, and provides a wizard for automatically finding feedback-prone frequencies.
7. **Loudness** – The Loudness screen provides controls to maintain a constant perceived tonal balance when the output level setting is adjusted.
8. **Limiter** – The Limiter screen provides controls to limit the output level.
9. **Prev / Next** buttons – Navigates to adjacent channels. The overall movement is circular; when the last channel is reached, continue in the same direction to start over.

Output Zone Master Controls

To the right of the screen are the channel's Master controls and indicators. These controls remain visible no matter which output channel's processing block is selected.

10. **Zone label** – Displays the name entered in the Setup Output Name field.
11. **Cue** – Sends the channel signal to the Cue headphone output.
12. **Output Channel label** – Displays the system number for the Output channel.
13. **L** – Indicates that the Limiter for the channel is engaged or not.
14. **AF** – Indicates that the Anti-Feedback Filters for the channel are engaged or not.
15. **Fader** – Adjusts the output level of the channel.
16. **Meter** – Indicates the channel signal level.
17. **Mute** – Mutes and indicates mute status of the channel.

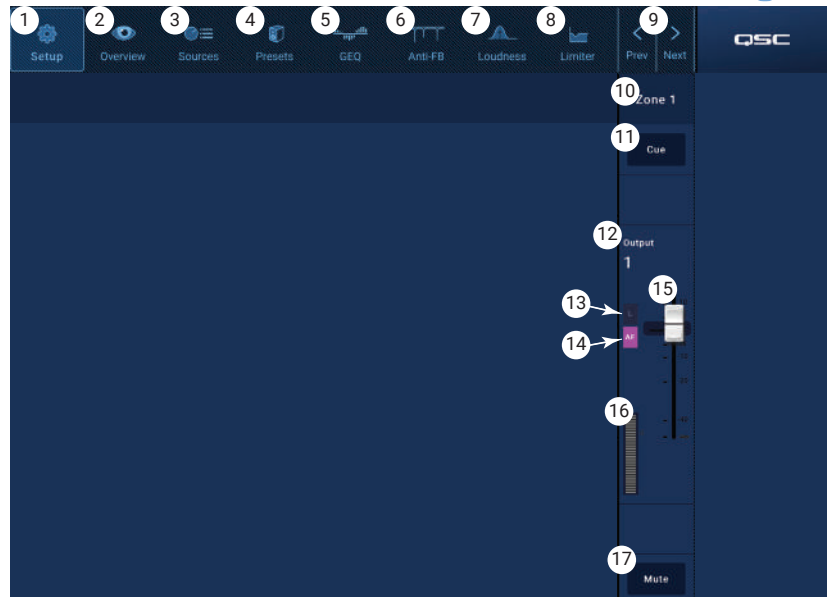
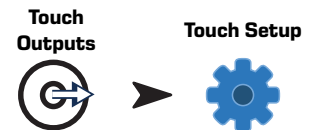

Output Zones – Setup / Delay

Various utility setup functions for Aux and Main output channels.

1. **Setup** button – Selects the Setup screen
2. **Stereo Link** – Links adjacent channels for stereo operation. Only odd / even linking is supported (1-2, 3-4, etc.). Even / odd linking (2-3, 4-5) is not available.

About Stereo Linking:

Signal routing and summing for linked inputs and outputs functions as follows:

- Mono input (source) to mono output (zone) – The mono source signal is output from the zone as a mono signal.
- Mono input (source) to stereo linked output (zone) – The mono source signal is routed equally to the odd and even numbered outputs.
- Stereo input (source) to mono output (zone) – The stereo source signal is summed and output to the zone as a mono signal.
- Stereo input (source) to stereo linked output (zone) – The stereo source signal from the odd numbered input channel is routed to the odd numbered output channel. The stereo source signal from the even numbered input channel is routed to the even numbered output channel.

3. **Reset** – Returns Setup parameters to factory default values.
4. **Output Name** – Displays the name of the output channel. Touch to display a keyboard and rename the output as needed.
5. **Polarity** – Engage to reverse the channel's polarity.
6. **Channel Safe** – When set to Safe, the channel will not be affected by a scene recall.
7. **Min/Max Output** – Sets a minimum and maximum level for the channel. These are the minimum and maximum settings that can be set from an MFC or from the MP Manage app. On the MFC and MP Manage app, the Min setting is displayed as 0% and the Max setting is displayed as 100%.
8. **Architectural Delay** – is variable up to 100 msec and is displayed in feet, meters and milliseconds.
9. **Delay Enable** – Engages or disengages the Delay.

About Delay:

The output delay on the MP-M is primarily useful for “architectural delay”. Architectural delay is used to align the arrival of sound from nearby speakers to the arrival of sound from a more distant source. When the delay is set correctly, the listeners will have the impression that they are hearing the distant source when most of what they hear is actually coming from the nearby speakers. To adjust the delay:

- Set the delay for the nearby speakers so that the distance equals the distance between the nearby speakers and the distant source. Note that the source could be an acoustic source such as a piano, guitar or a talker, or it could be another speaker system.
- Get into the coverage area of the nearby speaker. While listening to the source and the nearby speaker, add up to 30 msec. of delay. You'll know it's right when you're ear tells you that the sound is coming from the source.
- Precedence Effect (also known as Haas Effect) creates the illusion that we aren't hearing the delayed sound from the nearby speakers because we heard the sound from the distant source first.

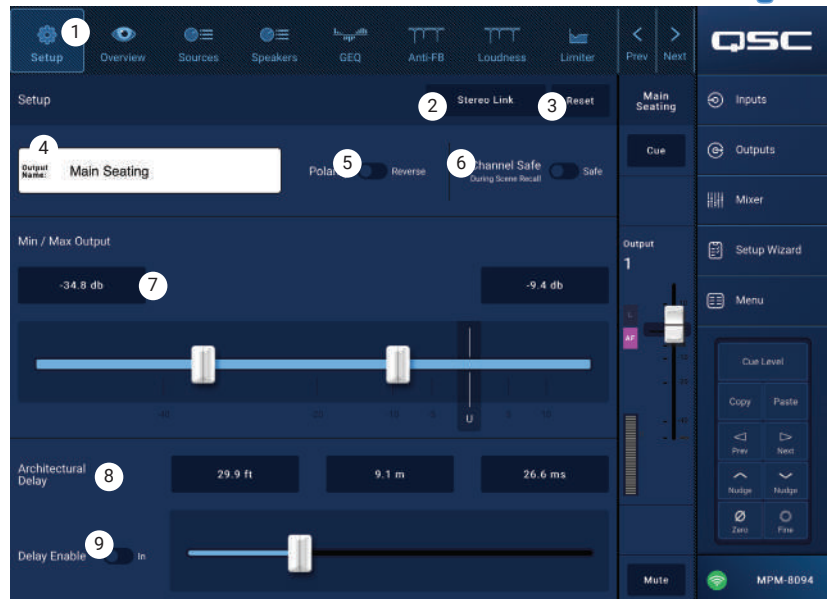
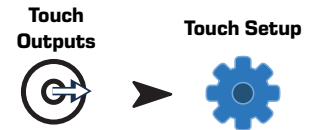

Output – Music On Hold (MoH)

The MP-M has the ability to route an input signal to a dedicated Music on Hold output that can be connected to a telephone system.

Note that the MoH output audio bandwidth has been deliberately limited to reduce distortion that may occur if excessive low-frequency signal is sent to a telephone system.

1. **Select Source** – Touch a source from the scrollable list.
2. Adjust the level control to the desired output level.

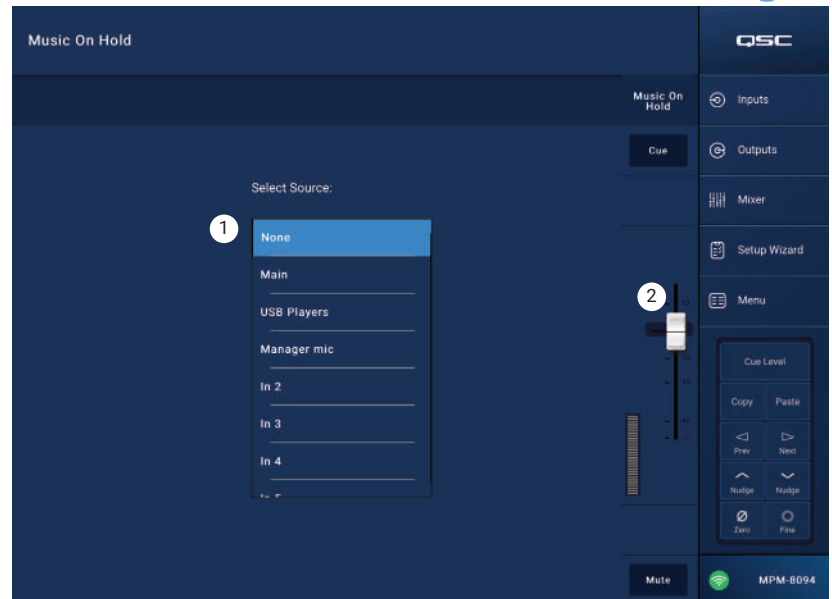

Output Zone – Overview

The output overview provides an aggregated, “at a glance” view of channel settings. Most of the controls are present on other processing blocks and will be described in detail in the sections covering their respective functions.

Outputs

Touch Zones

Touch a Channel Overview Button



1. **Overview** button – Touch to select the Overview screen.
2. **Preset** button – Displays the name of the currently loaded output channel preset. Touch to open the Preset screen.
3. **Reset** button – Returns the Zone output channel to factory default setting.
4. **Sources** – Displays the names of the sources selected from the Presets screen.
 - a. **Primary** display button – Touch to change the primary source.
 - b. **Secondary** display button – Touch to change the secondary source.
 - c. **Active** display button – Touch to change the active source.
5. **Anti-Feedback In** switch – Engages / disengages the anti-feedback filters.
6. **Stereo Link** display button – Indicates if the output is linked to the adjacent channel. Touch to toggle Stereo Link on and off.
7. **Tuning** display button – Displays the name of the currently loaded loudspeaker tuning. Touch to select a different tuning.
8. **Min / Max Output** –
 - a. Readout controls – Displays the current setting. Touch the readout and use the Nudge controls to adjust.
 - b. Sliders – Adjust the minimum and maximum output level for the output. Touch and drag to adjust.
9. **Loudness** –
 - a. **In** switch – Engages / disengages Loudness compensation and
 - b. Slider – adjusts the Threshold.
10. **Delay** –
 - a. Knob – Adjusts the output delay.
 - b. Button – Enables / disables the output Delay.
11. **GEQ** –
 - a. **In** switch – Engages / disengages the GEQ.
 - b. Sliders – Displays and allows adjustment of the settings for the output's graphic equalizer.
12. **Limiter** –
 - a. **In** switch – Engages / disengages the Limiter.
 - b. **Limiter** graph – Displays the settings for the limiter.
 - c. **Threshold** readout control – Touch to select; use the Nudge controls to adjust.
 - d. **Attack** readout control – Touch to select; use the Nudge controls to adjust .
 - e. **Release** readout control – Touch to select; use the Nudge controls to adjust



Output Channel – Sources

A primary purpose of the MP-M is to route audio signals from the inputs (Sources) to the outputs (Zones). The Sources screen is where the available sources are assigned to an output and given their roles.

The MP-M uses Priority Sources to designate which inputs are able to override the signal from other inputs. Each output zone includes two duckers that are triggered by the Priority inputs. (A ducker is a dynamic processor that uses one audio signal to reduce the level of another signal.)

Assignments to sources are made from MP Install and cannot be changed from the MP Manage app or the MFC controllers.

- A signal arriving at the Primary input will reduce the level of the Secondary Source and the Selectable Sources audio.
- A signal arriving at the Secondary input will reduce the level of the Selectable Sources audio but will not affect the Primary Source input.

1. **Sources** button – Selects the Sources screen.
2. **Reset** button – Returns all controls on the Sources screen to their factory default.

Priority Sources

3. **Primary / Secondary** switch – Selects either the Primary source selection and setup, or the Secondary source selection and setup.
4. **Source select** button – Touch the drop-down menu to display and select from a list of available sources for the priority input.
5. **Source Level** – Sets volume level for the Primary or Secondary signals relative to the other zone inputs.
6. **Override Zone Level** (Primary Source only) – When the switch is set to the Yes position, the Primary Source level will not be affected by the output's master level control. This allows, for example, a page message to be heard at a pre-set volume no matter what the zone's level setting may be.
7. **Threshold** – Sets the level that the priority source must reach to trigger ducking.
8. **Depth** – Sets the amount of attenuation applied to the Selectable Source when ducking is triggered.
9. **Hold** – Determines how long attenuation is applied after the Priority input signal drops below Threshold.

Selectable Sources

A single output (Zone) may have up to 8 Selectable Sources assigned to it.

10. **On** – Selects the associated source as the active source for the output.
11. **Selectable Source** buttons – Touch one of the selection buttons to display and select from a list of available sources. Available sources are:
 - Any input channel
 - The output from the internal mixer section of the MP-M.
 - Any other output zone or "Zone-Follows-Zone". This function is used, for example, if a single area of a facility has different kinds of loudspeakers (full-range / subwoofer) that require differing processing but it's desirable for the entire area to operate as a single zone. It can also be used for room combining in facilities with movable air walls.
 - Silence – Silence may be selected as a means of muting an output. If silence is selected, the Priority sources will still function normally.
 - None – None is the default selection. If None is the source for any of the 8 available source selection 'slots', that slot will not appear on MP Install or on the MFC controllers.
12. **Level** – Adjusts the level of each source relative to the other sources.

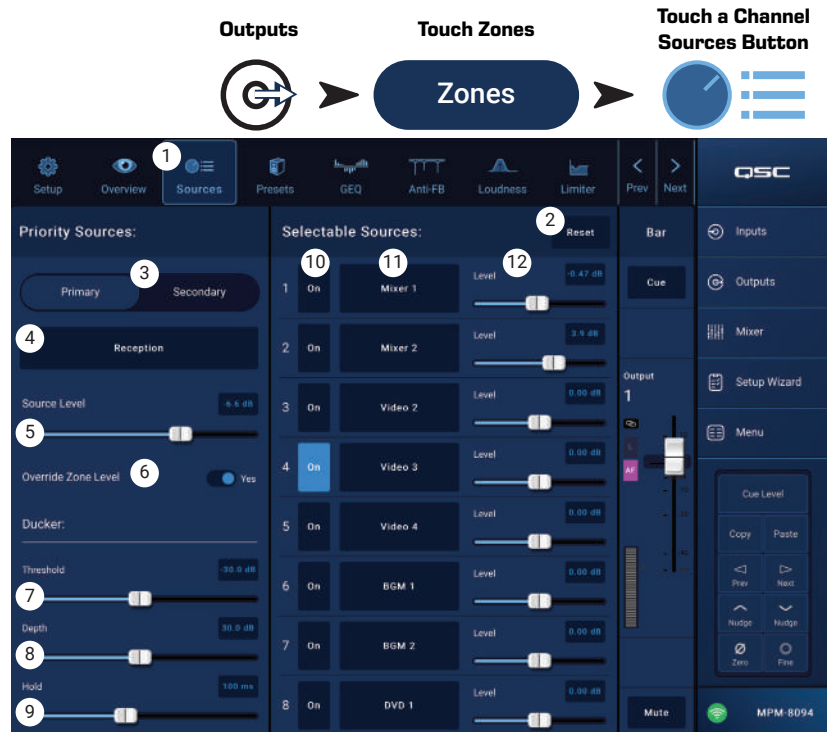

Output Zone – Presets

The Presets screen is used to perform these tasks:

- Recalling preprogrammed QSC loudspeaker tunings.
- Creating, saving and recalling custom loudspeaker tunings using the provided Filters and PEQ.
- Saving and recalling output channel settings.

Factory Loudspeaker Library

When Factory / User is set to Factory, a list of QSC loudspeakers is displayed. Factory tunings for QSC loudspeakers use a processing block, comprised of FIR and IIR filters, that is not user accessible.

Recalling a factory-tuned loudspeaker also recalls all of the factory default channel settings unless the Recall Omits have been set. (See item 6 below.)

To recall a QSC loudspeaker preset:

- Select a loudspeaker series from the **Series** panel. A list of QSC models from the selected series is displayed in the Type panel.
- Select a **Type** (model) from the Type panel. Some loudspeaker models may have variations on the basic tuning for use in different applications. These variations will be shown in the Preset Name panel.
- Make a selection from the **Preset Name** panel.
- Touch **Recall** to load the preset.

To clear a preset:

- Scroll to the top of the Series panel, select (Default)
- Touch **Recall**.

Controls:

- Presets** button – Opens the Presets screen.
- Filters/PEQ** button – Opens the Filters/PEQ screen (described below) where custom tunings can be created. This equalizer may also be used in addition to the factory tuning to “season to taste”.
- Preset Info** button – Displays a text box with information about the selected preset.
- Current Preset** field – Displays the name of the currently loaded loudspeaker preset.
- Factory / User** switch – Touch User to open a screen where custom user tunings and presets are stored and managed.
- Recall Omits** – When an Output Channel Preset is saved, all output channel settings are saved with the preset. The Recall Omits section allows some settings to remain unchanged when the preset is recalled.
 - Omit Levels and Sources** switch – Level and Source assignments are not affected by the preset recall.
 - Omit Speaker Tuning** switch – The factory and user tunings are not affected by the preset recall.
 - Omit Processing Blocks** switch – The GEQ, Anti-Feedback, Loudness, and Limiter are not affected by the preset recall.
- Recall** button – Loads the loudspeaker tuning selected from the Series, Type and Preset panel. If “Default” is selected, the factory tuning filters will be set to flat.
- Series** panel – A listing of selectable QSC loudspeaker families or Series.
- Type** panel – A listing of selectable loudspeaker Types or models belonging to the selected Series.
- Preset Name** panel – A listing of available presets for the selected Series and Type.



User Presets

The User Preset screen is where custom user tunings and presets are stored and managed.



NOTE: Controls described below are unique to the User Preset Library screen. Descriptions of controls which are visible on this screen, but not described below, may be found in the Factory Loudspeaker Library topic or the Filters / PEQ topic.

1. **Save / Save As** button – Opens a dialog box used to save all output channel settings to the internal MP-M memory, or a USB device attached to the MP-M. When a preset is saved, it becomes the Current Preset.



TIP: If a Factory Loudspeaker preset is recalled, it can then be saved as a user preset. This can be used as a start on which to build custom presets.

- a. **Save Preset As** field – touch the field to access a keyboard and enter a different name for the preset or, leave the name as it is, and continue to the next step.
 - b. **Storage Location** switch – Select either MP-M Internal (on the mixer), or USB attached to the mixer.
 - c. **Save** button – Touch the button to save the preset in the selected location.
 - d. **Cancel** button – Touch the button to exit the dialog without saving the preset.
2. **Factory / User** switch – When set to User, the User Loudspeaker Preset Library screen is displayed.
 3. **App Storage** list - Displays any user presets stored in the internal memory of the device being used to control the MP-M. When this panel is selected, the Copy to MP-M button will copy the preset to MP-M internal memory. You cannot Recall a preset from App Storage. To Recall, save the preset to MP-M Internal, then Recall.
 4. **MP-M Internal** list – Displays any user presets stored in the MP-M internal memory. When this panel is selected, the selected Preset can be copied to either the App Storage or USB External. In addition, the Preset can be recalled, then be saved or saved as a different preset.
 5. **USB External** list – Displays any user presets stored on a connected USB device. When this panel is selected, the selected Preset can be copied to the MP-M Internal storage. In addition, the Preset can be recalled, then can be saved or saved as a different preset.
- One item in the App Storage list, MP-M Internal list, or the USB External list must be selected for the following controls to be available.
6. **Copy To MP-M** button – Touch to copy a selected preset from the App Storage to the MP-M Internal storage.
 7. **Copy to USB** button – Touch to copy a selected preset from the MP-M Internal storage to the USB storage.
 8. **Copy To App** button– Touch to copy a selected preset from the MP-M Internal storage to the App Storage.
 9. **Copy to MP-M** button– Touch to copy a selected preset from the USB External storage to the MP-M Internal storage.
 10. **Delete** button – Deletes the selected preset.

Outputs

Touch Zones

Touch a Channel Presets Button



Zones

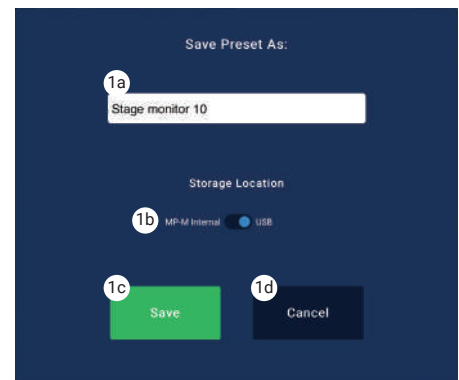
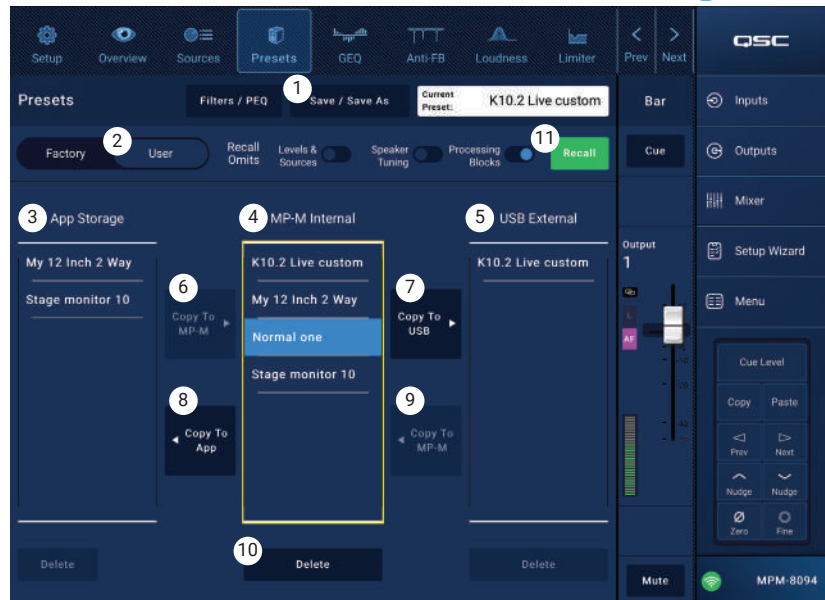

Filters / PEQ

The Filters / PEQ screen provides the tools to create custom speaker presets.

The PEQ is a 6-band, fully parametric EQ that includes variable HPF (High Pass Filter) & LPF (Low Pass Filter) and High and Low Shelving Filters.

1. **PEQ** button – Selects the EQ screen.
2. **Presets In** – Engages / disengages the equalizer.
3. **Filters / PEQ** button – Opens or closes the Filters / PEQ screen.
4. **LPF/HPF** button – Available only when the Filters / PEQ screen is open. Touch to display a dialog for setting the HPF and LPF slope and type.
 - a. Select either Butterworth or Linkwitz-Riley for both LPF and HPF.
 - b. Select the slope per octave: 12 dB, 18 dB, or 24 dB for each.
 - c. Touch the Close button to close the dialog box.
5. **RTA On** – Engages / disengages the real time analyzer that displays the tonal balance of the channel's signal including peak hold indicators.

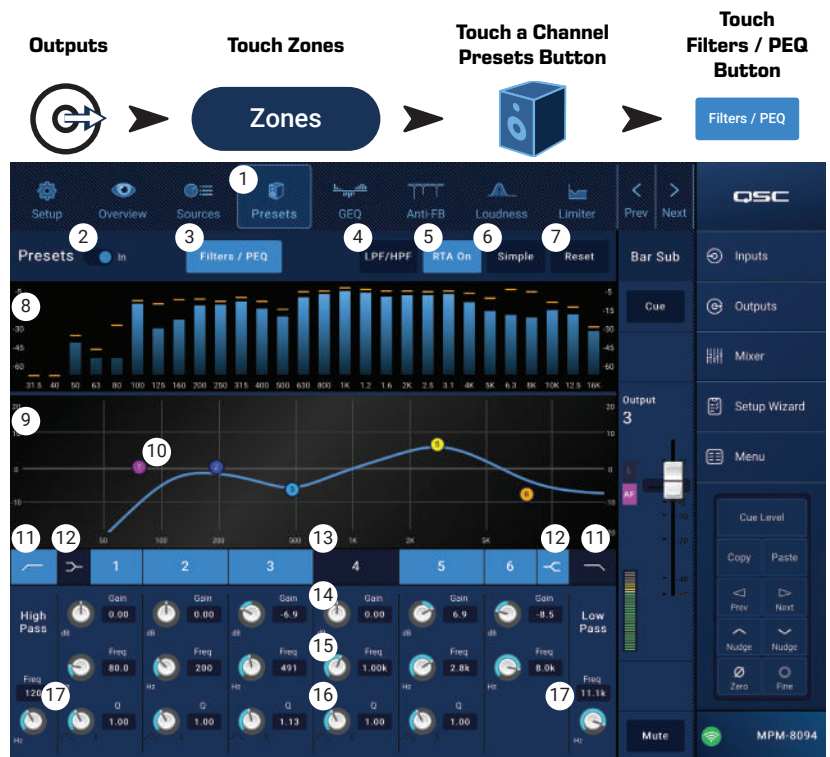

NOTE: Only one RTA may be running on the system at a time. Touch the RTA button. If another device is using the RTA, the message *“The RTA is currently being used by (device name) Do you want to assign it instead to this device?”*



NOTE: When the RTA is off, the Parametric EQ graph expands to use the entire graph area.

6. **Simple** button – Hides the Frequency, and Q controls for all bands and low and high cut filters. Changing to Simple mode does not affect existing settings.
7. **Reset** button – Sets all the PEQ controls to their factory default position.
8. **RTA** display – Displays the amplitude of the channel signal in 1/3 octave bands. Peak hold indicators are displayed for each band. The vertical scale represents audio level from -60 dB to -5 dB. The horizontal scale represents frequency from 31.5 Hz to 16 kHz.
9. **Parametric EQ** graph – A graphic representation of the equalization curve based on the PEQ settings. The trace dims to indicate that the PEQ is Out (disengaged). The vertical scale represents audio level from -20 dB to +20 dB. The horizontal scale represents frequency from 20 Hz to 20 kHz.
10. **EQ handles** – Touch, hold, and drag to change the Frequency and Gain of the associated PEQ band. The frequency band button must be engaged to see the handles.
11. **High Pass** and **Low Pass** buttons – Engages / disengages the HPF and LPF. The HPF is variable with a range of 20 Hz to 2,000 Hz. It passes frequencies above the setting while cutting those below. The LPF is variable with a range of 1 kHz to 20 kHz. It passes frequencies below the setting while cutting those above.
12. **Low Shelf and High Shelf** filter buttons – Changes EQ Band 1 and Band 6 from parametric filters to shelving filters. When a shelf filter is engaged, the Q control is not available. The low shelving filter raises or lowers a range of frequencies below the set frequency. The high shelving filter raises or lowers a range of frequencies above the set frequency. Bands 1 and 6 and their respective shelving buttons must be “on” for the shelving filters to work.
13. **Frequency Bands 1, 2, 3, 4, 5, and 6** buttons – Engages / disengages the associated parametric EQ band. Each band is fully parametric with a frequency range of 20 Hz to 20 kHz.
14. **Gain** control knob and readout – Adjusts the gain at the frequency setting of the associated EQ band. Range of -15 dB to +15 dB.
15. **Freq** control knob (Frequency bands 1 – 6) – Sets the center frequency of the associated EQ band. If the Shelving filter is engaged, the Freq control sets the knee frequency of the shelf filter.
16. **Q** knob – Adjusts the Q of the associated EQ band. When the Shelf Filter is selected, the Q control is hidden. In addition, Q can be adjusted by “pinching”.
17. **Freq control knob** (Low and High Cut) – Sets the frequency of the low and/or high cut filter as measured from a point 3 dB below 0 or unity.



Output Zone – Graphic Equalizer (GEQ)

Each output includes a 1/3 octave graphic equalizer (GEQ) that may be used to adjust the tonal balance of the output.

1. **GEQ** button – Touch to access the GEQ.
2. **Graphic Equalizer In** switch – Engages / disengages the GEQ.
3. **RTA On** button – Touch to activate / deactivate a Real Time Analyzer display for the output. When the RTA is not enabled, the GEQ screen is enlarged to occupy both the RTA and GEQ screen area.
4. **Reset** – Sets all GEQ faders to 0 (flat).
5. **GEQ Band** sliders – Touch and drag a slider to change the amplitude of the selected frequency band. Use the Nudge buttons and Fine button for greater precision.



Touch GEQ



Output Zone – Anti-Feedback

For applications in which microphones will be used for live sound reinforcement, the MP-M includes twelve narrow-band, anti-feedback filters on each output. These filters are extremely useful for eliminating feedback frequencies while having very little effect on overall tonal balance. The filters may be adjusted manually or automatically using the “Feedback Wizard”.



NOTE: In most situations, it is not necessary to use all 12 filters to achieve a stable system. Typically, 4 – 6 filters will be sufficient. Use of more filters may degrade sound quality unnecessarily.

1. **Anti-Feedback In** button – Engages / disengages the filters.
2. **Feedback Frequency** readout – The Anti-Feedback system automatically identifies and displays suspected feedback frequencies in real time.
3. **Manual Kill** button – When a suspected feedback frequency is identified, touching this button applies a filter at that frequency. The filter marker selected is simply the first available marker numerically.
4. **Wizard** button – Touching this button opens the Feedback Wizard which will guide the operator through the anti-feedback process.
5. **Reset** button – Sets all the Filter controls and markers to their factory default position. Note that the Feedback Wizard will only use a filter if its Cut has been set to 0.0.
6. **Display** – Shows the frequency and depth (cut) of applied filters.
 - **Vertical scale** = dB
 - **Horizontal scale** = frequency
7. **Filter markers** – These markers are color-coded to correspond with their associated controls. Horizontal position indicates frequency. The amount of cut is indicated by a descending vertical line.



NOTE: Markers and their associated frequency controls are not tied to a specific frequency band. Marker 1 may attenuate a high frequency, while Marker 12 may attenuate a low frequency.

8. **Filter In/Out** – The numbered buttons engage/disengage the filters. When a filter is disengaged, the associated marker is not displayed.
9. **Freq** – Sets the center frequency of a filter.
10. **Cut** – Adjusts amount of Cut (or attenuation) for a filter. Range is from 0.00 dB to -20.0 dB.
11. **Filter Depth** – Increases or reduces the depth (amount of cut) for all the filters.
12. **Filter Q** – Adjusts the width of the filter from a Q of 10 to a Q of 30.

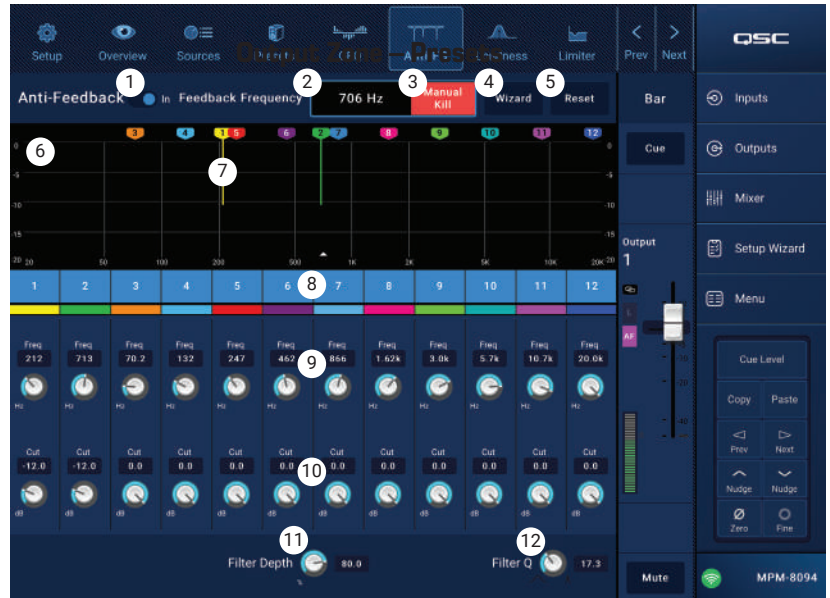

Output Zone – Loudness

How the human ear perceives tonal balance depends on the level of the sound being heard. As level decreases, more low-frequencies (relative to the mid-frequencies) are needed to maintain the perception that tonal balance is unchanged. Psychoacoustic research has established Constant Loudness Contours that describe how the perception changes with level.

The Loudness function works with the output Zone Level control to maintain a constant perceived tonal balance when the Zone Level setting is adjusted.

1. **Loudness** button – Selects the Loudness screen.
2. **Loudness In** switch – Engages and disengages the Loudness function. When “In” the Zone Level and Threshold lines are highlighted.
3. **Reset** button – Returns all controls to the factory settings.
4. **Equal Loudness Contours** – The graph represents the Equal Loudness Contours. It is a static image and is provided for reference purposes.
5. **Threshold** – Adjusts the point at which the Zone Output Level can be set without applying any loudness compensation. When the Output Level and the Threshold controls are both set to the same level, there will be no loudness compensation. If the Output Level is then lowered by 10 dB, a Loudness Contour that compensates for the 10 dB change is applied.
6. **Zone Level** – Graphic representation of the Zone channel Output Level.
7. Shaded Area – The difference between the Threshold setting and the Zone Level setting will be represented by a shaded area overlaying the Equal Loudness Contours.
8. **Scale** – The Scale control adjusts how much loudness compensation is applied. If too much low-frequency is heard at low level, reduce the setting. If more low-frequency is desired at lower-levels, increase the Scale value.

To Set Loudness Compensation:

1. Bring the Zone channel Output Fader up to the level at which there should be no loudness compensation applied. This will usually be the loudest, normal operating level for the output zone.
2. Adjust the Threshold slider so that the blue Threshold line overlays the white Zone Level line.
3. Use the Scale control to adjust how much compensation is applied. To set the Scale, bring the Zone output level to the lowest normal operating level. If too much Loudness Compensation is present, reduce the Scale setting.

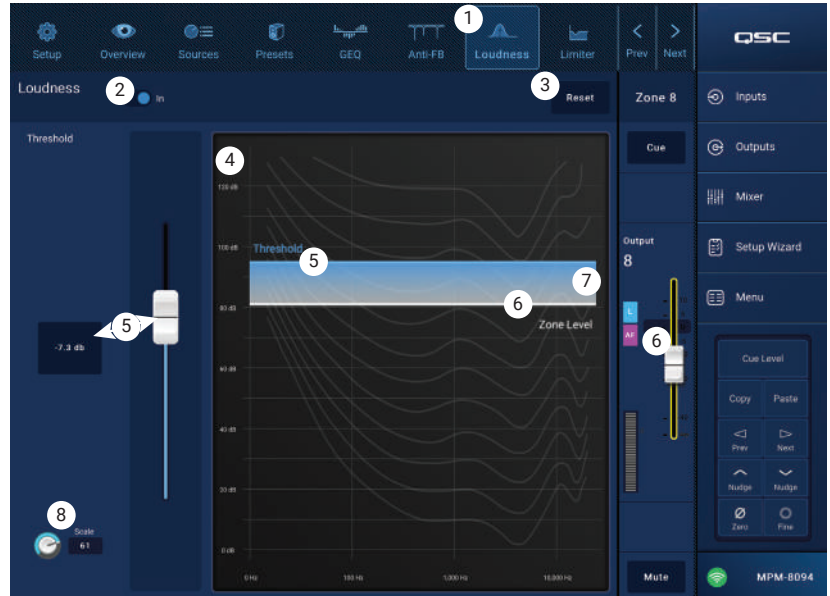
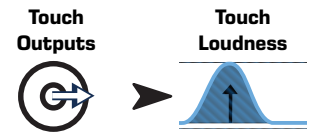

Output Zone - Limiter

Touch Outputs

Touch Limiter



The Limiter prevents the audio level from exceeding a preset threshold.

1. **Limiter** – Opens the Limiter screen.
2. **Limiter Out/In** switch – Engages or disengages the compressor or limiter.
3. **Simple** button – Hides all controls except:
 - Limiting Slider
 - Limiter In button
 - Simple button
 - Reset button
4. **Reset** button – Sets all the Limiter controls to their factory default position.
5. **In** meter – Displays the RMS input signal level
6. **Reduction** meter – indicates how much the signal level is reduced by the Limiter.
7. **Output** meter – Output signal level
8. **Limiter** graph – When engaged, the Limiter trace is fuchsia.
 - **Threshold** (A) – The level at which limiting begins.
 - **Attack time** (B to C) – The time it takes for the limiter to reach maximum limiting after the input exceeds the threshold level.
 - **Ratio** (A to E) – The amount of limiting applied to the signal.
 - **Release** time (C to D) – The time it takes for the limited signal to rise to the threshold level once the input level no longer exceeds the threshold.
 - Vertical scale = dB
9. **Threshold** slider – Sets the point at which the limiter begins to reduce the signal level.
10. **Attack** slider – Adjusts how quickly the processor reacts to a signal that exceeds the threshold.
11. **Release** slider – Adjusts how quickly the processor stops compressing or limiting when signal falls below the Threshold.



Mixer

The MP-M includes a stereo mixer with Auto-Mix capability and an FX engine allowing it to be used for meeting/conference or live entertainment applications. All MP-M Input Channels are available as an audio source to the mixer. The mixer's stereo output can be used as an audio source for any of the MP-M Output Channels.

Touch Mixer



Mixer Main – Block Diagram

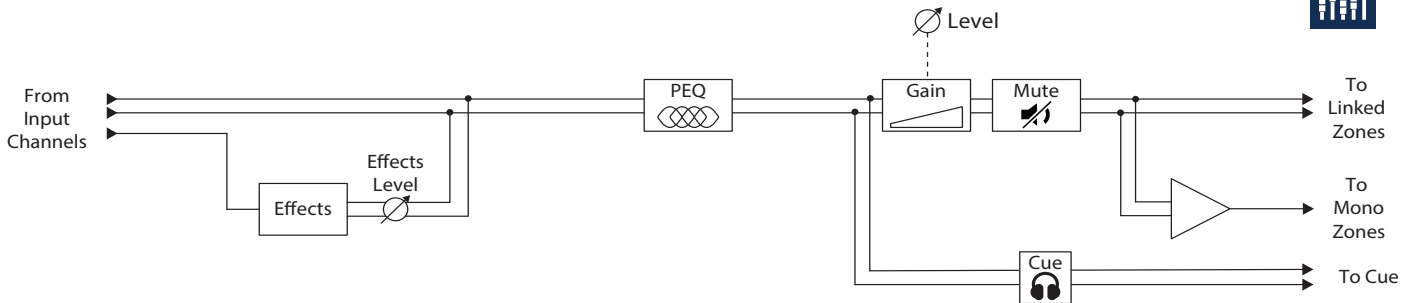

Mixer Main – Home Screen

(MP-M80 shown)

Touch Mixer



1. **Inputs** 1–8 (Mic/Line), Inputs 9–16 (RCA), USB/FX (USB Player and FX Channel) banks – Select a bank (or group) of Input Channels.
2. **Select** (Input Channel Name) – Displays the Input Channel's friendly name. Touch to access the Input PEQ, Compressor, AGC, Gate, Presets, and setup screens.
3. **Main** – Touch to access the Mixer's Main channel 6-band PEQ screen.
4. **Cue** – Routes the Input Channel's signal to the Cue (headphone) output.
5. **Pan** – Places the channel's signal in a stereo sound field.
6. **Level** faders – Adjusts the output level from the Input Channels going to the Mixer Main channel.
7. **Level** meter – Indicates the pre-fader signal level from the Input Channels.
8. **Main Level** meter – Indicates the post-fader output of the Mixer Main channel.
9. **Main Output** fader – Adjusts the output level of the Mixer. The Main output can be selected as a Source for any of the Zone outputs.
10. **Auto-Mix** – Engages the automatic microphone mixer.
The MP-M auto-mixer is a gain-sharing design and may be used on any or all of the Mic/Line input channels. It works by comparing the signals from the input channels and applying attenuation (level reduction). In operation, the auto-mixer senses which channels are being spoken into and allocates gain to the active channels while reducing gain of the inactive channels.
11. Mute button – Mutes the Input Channel
12. Mute button – Mutes the Main Mixer output.

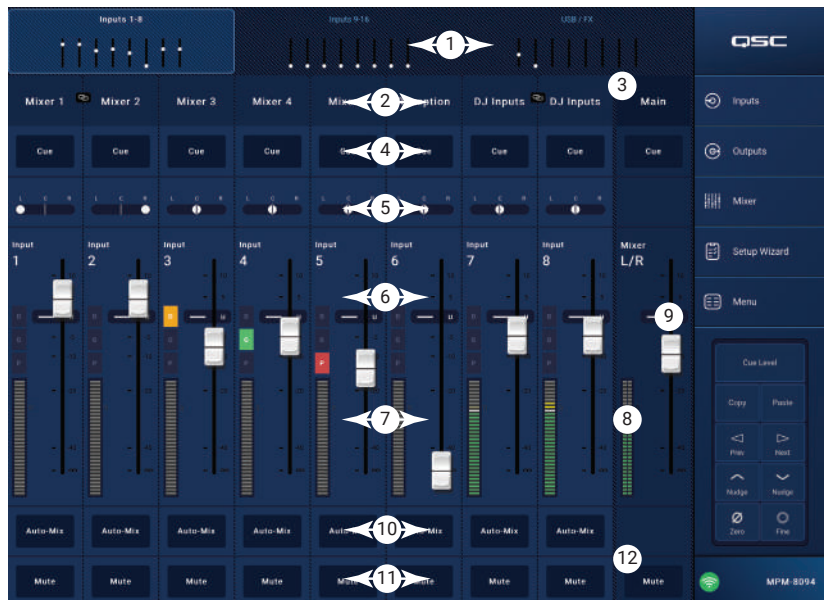

Mixer Main – PEQ

This screen controls and displays the settings for the Mixer Main Channel parametric equalization.

The PEQ is a 6-band, fully parametric EQ that includes variable High Shelf and Low Shelf Filters. Bands 1 and 6 may be configured as shelving filters.

1. **PEQ** tab – Selects the EQ screen.
2. **PEQ Out/In** – Engages / disengages the equalizer.
3. **RTA On** – Engages / disengages the real time analyzer that displays the tonal balance of the channel's signal including peak hold indicators.



NOTE: Only one RTA may be running on the system at a time. Touch the RTA button. If another device is using the RTA, the message shown above displays.

The RTA is currently being used by [device name]. Do you want to assign it instead to this device?

Yes	No
-----	----



NOTE: When the RTA is off, the Parametric EQ graph expands to use the entire graph area.



4. **Simple** button – Hides the Frequency, and Q controls for all bands. Changing to Simple mode does not affect existing settings.
5. **Reset** button – Sets all the PEQ controls to their factory default position.
6. **RTA** display – Displays the amplitude of the channel signal in 1/3 octave bands. Peak hold indicators are displayed for each band.
 - **RTA** graph vertical scale – Represents audio level from -60 dB to -5 dB.
 - **RTA** graph horizontal scale – Represents frequency from 31.5 Hz to 16 kHz.
7. **Parametric EQ** graph – A graphic representation of the equalization curve based on the PEQ settings. The trace dims to indicate that the PEQ is Out (disengaged).
 - **EQ** graph vertical scale – Represents audio level from -20 dB to +20 dB.
 - **EQ** graph horizontal scale – Represents frequency from 20 Hz to 20 kHz.
8. **EQ** handles – Touch, hold, and drag to change the Frequency and Gain of the associated PEQ band. The frequency band button must be engaged to see the handles.
9. **Low Shelf and High Shelf** filter buttons – Changes EQ Band 1 and Band 6 from parametric filters to shelving filters. When a shelf filter is engaged, the Q control is not available. The low shelving filter raises or lowers a range of frequencies below the set frequency. The high shelving filter raises or lowers a range of frequencies above the set frequency.
10. **Frequency Bands 1, 2, 3, 4, 5, 6** buttons – Engages / disengages the associated parametric EQ band. Each band is fully parametric with a frequency range of 20 Hz to 20 kHz.
11. **Gain** control knob and readout – Adjusts the gain at the frequency setting of the associated EQ band. Range of -15 dB to +15 dB.
12. **Freq** control knob (Frequency bands 1 – 6) – Sets the center frequency of the associated EQ band. If the Shelving filter is engaged, the Freq control sets the knee frequency of the shelf filter.
13. **Q** knob – Adjusts the Q of the associated EQ band. When the Shelf Filter is selected, the Q control is hidden. In addition, Q can be adjusted by “pinching”.

Mixer – FX Channel

Mixer – FX Effect

The FX Channel is used to assign an effect to any of the Input Channels used as inputs to the mixer. Each input channel can have different levels of the effect applied. With the exception of the amount, or level of the effect, all other effect parameters are applied equally to the channels

- Effect** button – Displays the Effect selection screen.
- Effect** select button – Touch to display a pop-up to make an effect selection. The following selections are available:
 - Mono Delay
 - Stereo Delay
 - Chorus
 - Pitch Shift
 - Dense Reverb
 - Lush Reverb
 - None
 - Cancel
- Preset** button – Touch to display the FX Presets screen where preset selection can be made.
- Reset** button – Resets all Effect controls to the factory default.
- Input** meter – Displays the input signal level.
- Output** meter – Displays the Output signal level after the effect has been applied.
- Effect** controls – These controls set the parameters for the effect. Each effect has its own controls to give its unique sound.
- FX Inputs** sliders – These control the amount of Input Channel signal going through the Effect. When the slider is at the left side, none of that Input Channel goes through the effect processor. Far right gives that Input Channel the full effect of the Effect.



Mixer – FX Presets

The MP-M includes presets for each of the available Effects.

An FX Channel Preset consists of settings for the channel EQ, Effect, and changes to the Effect that can be saved and recalled.

Factory Presets

- Presets** button – Touch to display the Presets screen.
- Save / Save As** button – Touch to save the Current Preset or save with a new name.
- Current Preset** field – Displays the name of the currently active preset.
- Recall** button – Touch to recall the preset selected in the Selection windows.
- Factory** window – Displays a list of presets for the selected Effect. Touch one then touch Recall.
- MP-M Internal** window – Displays a list of presets that have been saved or copied to the MP-M Internal memory.
- USB External** window – Displays a list of presets that have been saved or copied to a USB device attached to the MP-M.



Mixer – FX Shelf EQ

This screen controls and displays the settings for the FX Channel high and low shelf equalization and high-pass filter.

- The HPF is variable with a range of 20 Hz to 2,000 Hz. It passes frequencies above the setting while cutting those below.
- Bands 1 and 2 are shelving filters.

1. **PEQ** tab – Selects the EQ screen.
2. **PEQ Out/In** – Engages / disengages the equalizer.
3. **RTA On** – Engages / disengages the a real time analyzer that displays the tonal balance of the channel's signal including peak hold indicators.



NOTE: Only one RTA may be running on the system at a time. Touch the RTA button. If another device is using the RTA, the message to the right displays.

The RTA is currently being used by [device name]. Do you want to assign it instead to this device?

Yes No

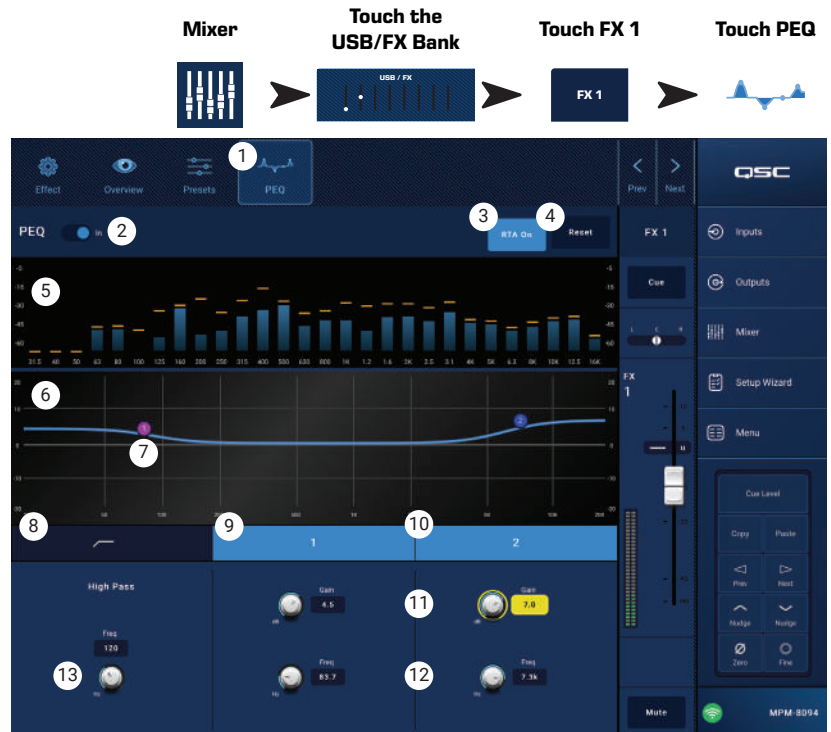

NOTE: When the RTA is off, the Parametric EQ graph expands to use the entire graph area.

4. **Reset** button – Sets all the EQ controls to their factory default position.
5. **RTA** display – Displays the amplitude of the channel signal in 1/3 octave bands. Peak hold indicators are displayed for each band.
 - **RTA** graph vertical scale – Represents audio level from -60 dB to -5 dB.
 - **RTA** graph horizontal scale – Represents frequency from 31.5 Hz to 16 kHz.
6. **EQ** graph – A graphic representation of the equalization curve based on the EQ settings. The trace dims to indicate that the EQ is Out (disengaged).
 - **EQ** graph vertical scale – Represents audio level from -20 dB to +20 dB.
 - **EQ** graph horizontal scale – Represents frequency from 20 Hz to 20 kHz.
7. **EQ** handles – Touch, hold, and drag to change the Frequency and Gain of the associated EQ band. The frequency band button must be engaged to see the handles.
8. **High Pass** button – Engages / disengages the HPF (described above).
9. **Low Shelf and High Shelf** buttons – EQ Band 1 and Band 2 are shelving filters. The low shelving filter raises or lowers a range of frequencies below the set frequency. The high shelving filter raises or lowers a range of frequencies above the set frequency.
10. **Frequency Bands 1 and 2** buttons – Engages / disengages the associated shelving EQ band.
11. **Gain** control knob and readout – Adjusts the gain at the frequency setting of the associated EQ band. Range of -15 dB to +15 dB.
12. **Freq** control knob (Frequency bands 1 – 2) – Sets the knee frequency of the associated shelf band.
13. **Freq control knob** (High Pass) – Sets the frequency of the high pass filter as measured from a point 3 dB below 0 or unity.

Setup Wizard

Setting up a multi-source, multi-zone system can be a complex project that requires completion of many tasks. The Setup Wizard assists in three ways.

- It provides a list, in work-flow sequence, of the individual tasks that need to be accomplished.
- As the tasks are completed, the installer can check them off using the provided check-off button.
- Each task also includes a link button for one-touch navigation to the pages where the task is executed.

On the Screen

1. Progress bar
2. Task title
3. Link to task's screen
4. Task check-off button

Touch Setup Wizard

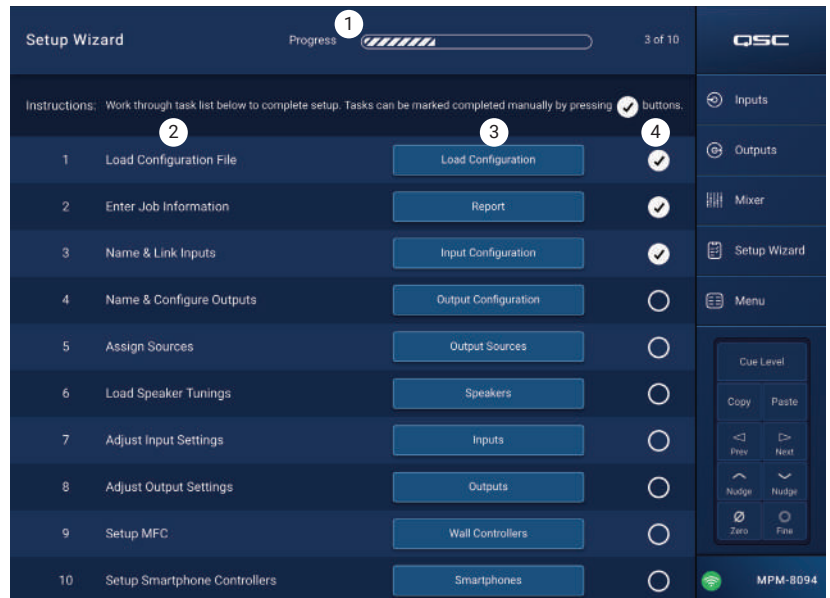

Wizard Steps

Task No.	Task Title	Link to Screen
1.	Load Configuration File:	Load Configuration
2.	Enter Job Information:	Reports
3.	Name and Link Inputs:	Input Setup
4.	Name and Configure Outputs:	Output Setup
5.	Assign sources:	Output Sources
6.	Load Speaker Tunings:	Output Speaker
7.	Adjust Input Settings:	Input Overview
8.	Adjust Output Settings:	Output Overview
9.	Set up MFC:	Controllers
10.	Set up Smartphone Control:	Smartphone

The completion status of the Setup Wizard is captured in the Report.

Menu

Menu – Home Screen

Provides access to various utility functions. Each function is described below.

1. **Configurations** button – Recall and save system Configurations
2. **Scenes** button – Recall, save, and manage Scenes. Scenes can include the values of all settings for the included input channels, output channels and the mixer section.
3. **Scheduling** button – Schedule Scene recalls or “Events”.
4. **Controllers** button – Manage MF-C (Multi-function Controllers.)
5. **Smartphone** button – Manage access profiles for Smartphones.
6. **GPI Setup** button – Setup GPI (General Purpose Input) functionality
7. **Report** button – Generate System Report
8. **System Test** button – Check Audio Inputs and Outputs
9. **Network** button – Setup the MP-M Network
10. **Security** button – Manage Login and Passwords
11. **Settings** button – Manage hardware settings and software upgrades.

Touch the button for the desired functionality.

Touch
Menu

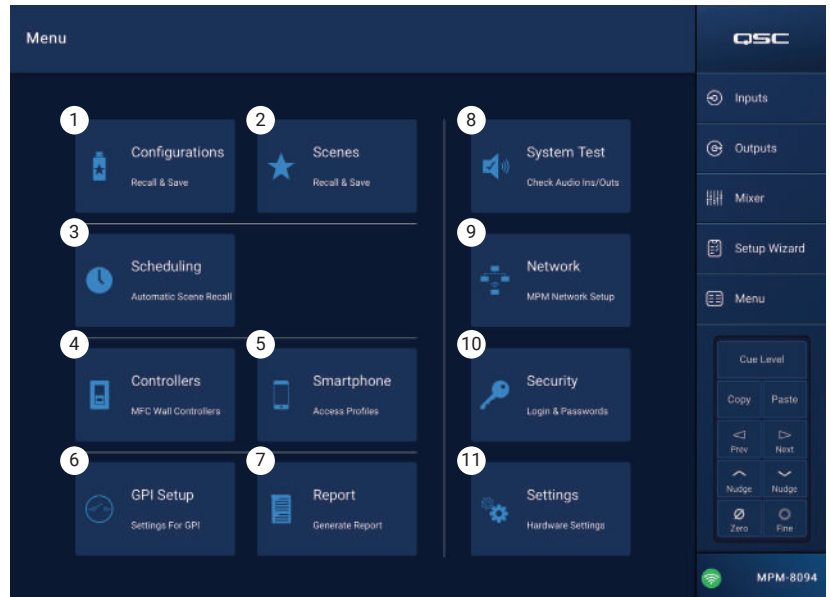

Menu – Configurations

A Configuration is a design file that contains all mixer settings including presets, permissions and scenes. The Configuration may be created online or offline. If a Configuration is exported from one MP-M and loaded onto another, the second MP-M becomes functionally and operationally identical to the first.

Configurations may be stored on:

- A Windows computer (MP Install App Storage location).
- A USB storage device (connected to the MP-M).
- An iOS or Android tablet (MP Install mobile app storage).
- The MP-M internal memory.

Managing Configurations – Online

The Configurations screen includes the following controls and indicators:

1. **Save / Save As** button – Opens the Save Configuration As dialog where the configuration can be saved as is, or saved with a new name, effectively creating a new version. When the App is connected (live) to the MP-M and a configuration is saved or saved as, that configuration becomes the Current Configuration
 - a. **Save Configuration As** – Touch the name box to rename the configuration or leave the name as is to overwrite the existing configuration.
 - b. **Storage Location** – Determines where the configuration is to be saved.
 - » **MP-M Internal** – Saves the configuration to the MP-M internal memory.
 - » **USB** – Saves the configuration to a USB storage device attached to the mixer.
 - c. **Save** – Saves the configuration to the selected name and location.
 - d. **Cancel** – Closes the Save Configuration As dialog without saving the configuration.
2. **Current Configuration** – Displays the name of the configuration that is currently loaded to the mixer.
3. **Recall** – Touch to recall the selected configuration in either the MP-M Internal, or USB External list. Only one configuration, in one list, can be selected.



NOTE: There are three possible storage locations for a configuration file. The configuration files display in one or more of three panels. Each panel represents one of the three storage locations.

4. **App Storage** – Displays a list of configurations that are stored in the tablet's memory or designated Windows directory. Configurations cannot be recalled from the tablet and must be copied to the mixer or USB memory.
 - a. **Change Directory** (Windows only) – If the app is running on a Windows PC, the chosen path for asset storage is displayed on the Configurations screen. To change the path, click the Change Directory button to open Windows Explorer navigation and select a new location.



NOTE: Changing the directory does not move or copy assets from the old location to the new location. It only designates a new location to store assets from that point forward. Assets may be manually moved or copied from any location to the new location and will appear in MP Install when it is re-launched.

5. **MP-M Internal** – Displays a list of configurations that are stored in the mixer's internal memory. These configurations may be recalled.
6. **USB External** – Displays a list of configurations that are stored on a USB memory device attached to the MP-M. These configurations may be recalled.
7. **Copy to MP-M** – Copies the selected Configuration file to the MP-M internal memory.
8. **Copy to USB** – Copies the selected Configuration file to a USB memory device attached to the MP-M. Configurations may not be copied from a USB to the App Storage.
9. **Copy to App** – Copies the selected Configuration file to the App storage. Configurations may not be copied from the App Storage to a USB.
10. **Export from App** – From a tablet, select a configuration and touch Export from App to open a dialog box with options for sharing the configuration file via email or uploading the configuration to cloud storage. Note that an internet connection is required. From Windows, select a configuration and click Export from App to open Windows Explorer navigation and select a location to export the configuration file.
11. **Delete** – Deletes the selected configuration from memory.

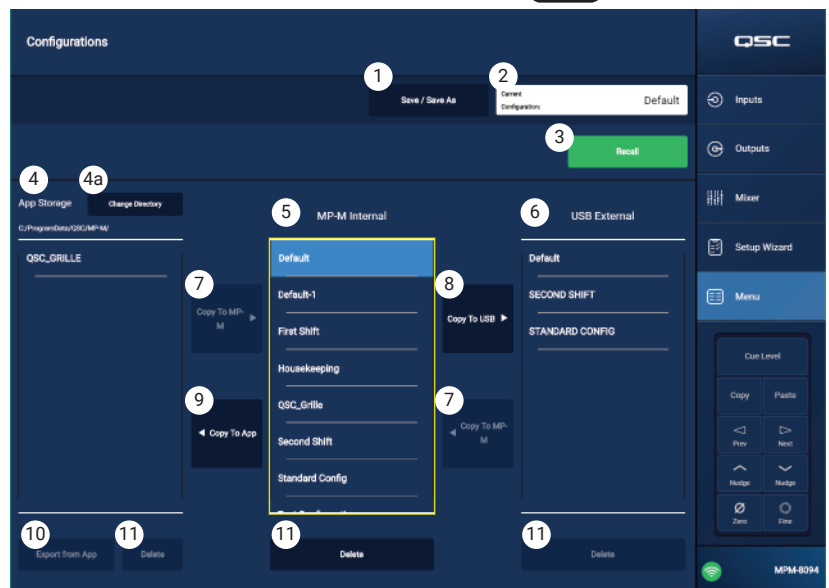

Windows Screen Shown

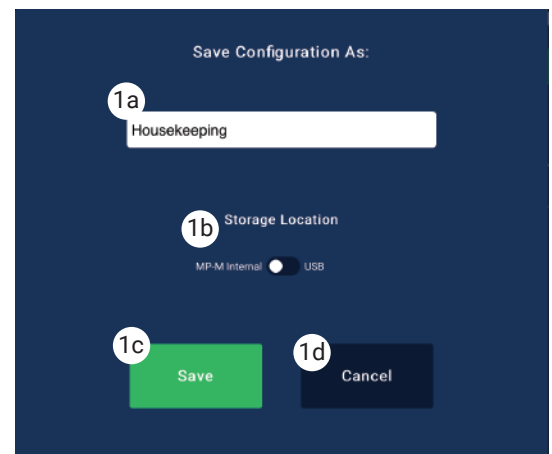

Managing Configurations – Offline

The MP Manage app supports offline operation allowing most aspects of MP-M setup to be performed on a tablet or computer without being connected to an MP-M. This includes the creation of configurations.

When the app is offline, it uses the configuration that was last opened in offline mode. When the app connects to an MP-M, the MP-M online configuration takes over. To restore the offline configuration, click the Connection button on the lower right corner of the screen and select None (offline). The last offline configuration to be recalled will be loaded. Even so, it's good practice to save any offline or online configuration before changing mode.

Configurations include a password whether they are created online or offline. For this reason it may be necessary to enter a password when switching between an online and an offline configuration.

Configuration Files and Windows

- Having full file system access with the Windows version of MP Install offers the user more file management control to accommodate more varied workflows.
- Therefore, the Windows handling of Configurations differs slightly from the tablet versions of MP Install.
- By default, MP Install will store Configuration files in the current user's Documents directory. The default storage location for MP Install v1.0 was C:\ProgramData\QSC\MP-M\.

For v1.1 and later, the default location is:
%USERPROFILE%\Documents\QSC\MP-M\

Which, for example, may equate to an absolute path of C:\Users\my.name\Documents\QSC\MP-M\

Common Workflow Scenarios

Fresh Start (New Configuration)

In this scenario, there may or may not be any configurations in the MP Install App Storage location on the Windows PC. Either way, an existing configuration will not be used. The user will most likely be working offline.

Best practice steps to get started:

1. Launch MP Install.
2. Click Menu, then Configurations.
3. Click Save / Save As.
4. Enter a name for your new Configuration and click Save.
5. Get to work.

Basing a New Configuration on an Existing Configuration (Template)

In this scenario, there will be at least one configuration in the MP Install App Storage location on the Windows PC. The user will most likely be working offline.

Best practice steps to get started:

1. Launch MP Install.
2. Click Menu, then Configurations.
3. Select a Configuration to use as a basis or "template" and click Recall.
4. Click Save / Save As.
5. Enter a name for your new Configuration and click Save.
6. Get to work.

Continuing Work on Existing Configuration (Recalling)

In this scenario, there will be at least one configuration in the MP Install App Storage location on the Windows PC. The user will most likely be working offline.

Best practice steps to get started:

1. Launch MP Install.
2. Click Menu, then Configurations.
3. Select a Configuration and click Recall.
4. Get to work.

Importing a Configuration

In this scenario, there may or may not be any configurations in the MP Install App Storage location on the Windows PC. The user may have been provided a configuration file created by a colleague or on another device that they wish to continue working on or deploy to hardware. The user will most likely be working offline.

Best practice steps to get started:

1. Store your file somewhere accessible by Windows Explorer and browse to that location.
2. Ensure MP Install is not running. Exit it if it was.
3. Double-click the configuration file. MP Install will launch and import the configuration into the specified App Storage location. A message will convey the import operation is taking place and notify when complete.
4. Click Menu, then Configurations.
5. Select the imported Configuration and click Recall.
6. Get to work.

Transferring a Configuration to an MP-M Using a USB Drive

If a configuration has been saved to a USB drive from an MP-M, the drive may be used, as is to transfer the configuration to another MP-M. If the Configuration is copied to a USB drive, the USB drive must be prepared as follows.

Prepare a USB drive.

- If an MP-M is available, it may be used to format the drive. Menu > Settings > Format USB Drive. The directory structure will be created by the MP-M.
- If no MP-M is available, format the drive as FAT32 using the computer.
- Create a folder on the drive and name it MPM_Settings.



NOTE: MP-M mixers with firmware versions earlier than 1.1 search for the Configuration files in a folder named TouchMix-Presets. If this is the case you may update the MP-M firmware to the latest version or use a folder name TouchMix-Presets on the USB drive.

The Configurations Screen includes a summary of these steps.

To Transfer a Configuration Using a USB Drive

- Format drive as FAT32.
- Create a folder named MPM_Settings.
- Save Configurations to the folder.

Transfer the Configuration using one of the following methods.

1. Method 1
 - a. From the Configurations screen, select a Configuration from the App Storage window.
 - b. Click the Export Selected Configuration button. A dialog will appear “Export Configuration file “Config Name” to another location?”
 - c. Select Continue to save the Configuration or Exit to go back.
 - d. Browse to the MPM_Settings folder on the USB drive and click Save.
2. Method 2
 - a. Using Windows Explorer, navigate to the folder where the Configuration is stored.
 - b. Select the Configuration (or Configurations) and copy/paste or drag them to MPM_settings folder on the USB drive.

Menu – Scenes

A Scene includes the values of all settings for input channels, output channels and the mixer section.

- Scenes may be limited to individual input channels, individual output channels or the mixer section of the MP-M in any combination.
- Omitted sections are unaffected by a Scene recall.
- Underlying settings such as those for network settings, permissions, and controller configurations are not part of a Scene.
- At the installer's discretion, facility staff may edit and save level, source selection and mixer (the MP-M internal live sound mixer) settings for Scenes using the MP Manage app. No other Scene parameters are accessible from MP Manage.

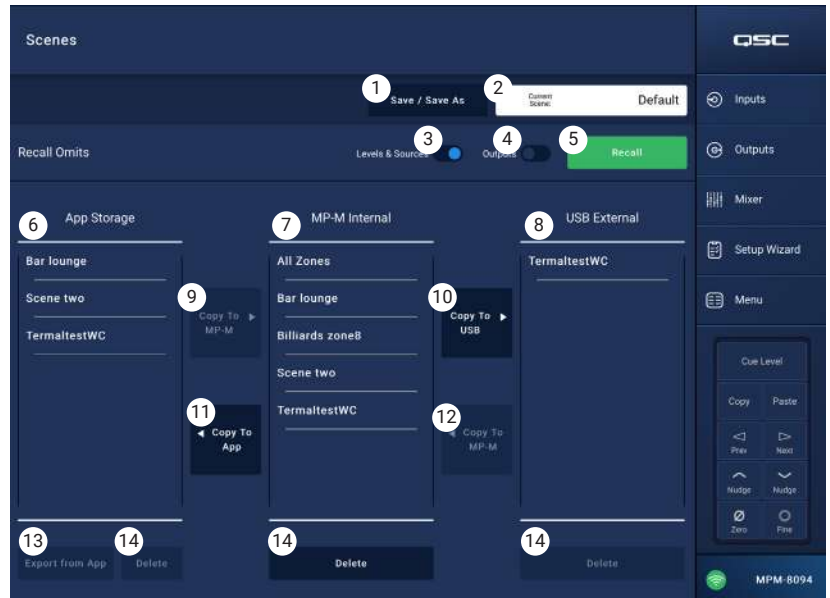
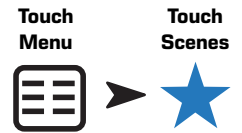

NOTE: When a scene is created and saved to the MP-M memory, it automatically becomes part of the MP-M Configuration. Individual scenes may also be saved to a USB drive. Once saved, scenes may be copied to a tablet. Since some of the MP-M settings can be omitted from a Scene it's possible to create a Scene that, when recalled over existing settings will function in an undesired way.

1. **Save / Save As** – Touch the Save / Save As button to display a dialog and determine how the scene is saved.
2. **Current Scene** field – Displays the name of the configuration that is currently loaded to the mixer.



NOTE: Recall Omits switches (Levels & Sources and Outputs) can be set to protect selected parameters from being altered by a scene recall.

3. **Levels & Sources** switch – Move to the right to prevent any change to output level and source selection for the output zones.
4. **Outputs** switch – Move to the right to prevent any change to the output processing settings.
5. **Recall** button – Touch to recall the selected Scene in either the MP-M Internal, or USB External storage location.
6. **App Storage** list – Displays a list of scenes that are stored in the tablet's memory. Scenes cannot be recalled from the tablet and must be copied to the mixer or USB memory.
7. **MP-M Internal** list – Displays a list of scenes that are stored in the mixer's internal memory. These scenes may be recalled.
8. **USB External** list – Displays a list of scenes that are stored on a USB memory device attached to the MP-M. These scenes may be recalled.
9. **Copy To MP-M** button – Touch to copy a selected scene from App Storage to the MP-M Internal storage.
10. **Copy to USB** button – Touch to copy a selected scene from MP-M Internal storage to the USB storage.
11. **Copy To App** button – Touch to copy a selected scene from MP-M Internal storage to the App Storage.
12. **Copy to MP-M** button – Touch to copy a selected scene from USB External storage to the MP-M Internal storage.
13. **Delete** button – Deletes the selected scene from memory. Each storage location has its own Delete button.
14. **Export from App** button – Select a scene and touch Export from App to open a dialog with options for sharing the scene file via email or uploading the scene to cloud storage. Note that an Internet connection is required.

Menu – Scheduling

The Scheduling screen is used to set up scheduled recall of scenes. Each scheduled recall is known as an Event. This function is also supported in MP Manage if enabled by the installer.

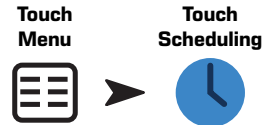

NOTE: Scheduling depends on the internal clock of the MP-M being set to the correct time. If the MP-M is connected to the Internet, its internal clock will be automatically updated. If it is not connected to the Internet, the clock may be set to match the time of a connected device from the settings screen.

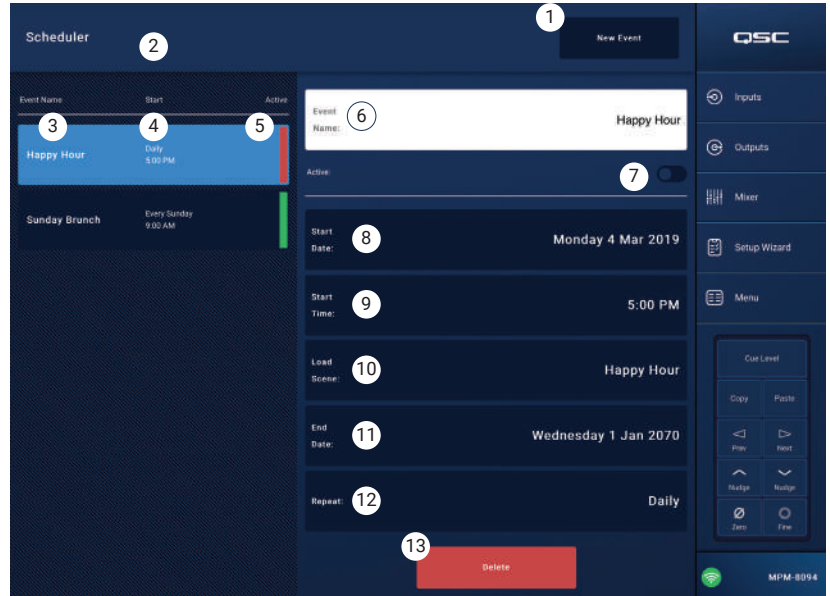

1. **New Event** button – Touch this button to create a new scheduled event.

Left Side of Screen

2. **Event List** – Displays a scrollable list of events
3. **Event Name** – The user-defined event name
4. **Start** – Frequency and start time of the event
5. **Active** – Green is active, red is inactive

Right Side of Screen

6. **Event Name** field – Touch to enter a name for the event.
7. **Active** switch – Activates or deactivates the event without changing any of the event settings.
8. **Start Date** button – Displays a pop-up to set the date when the event is to occur for the first time.
9. **Start Time** button – Displays a pop-up to set the time of day the event is to occur.
10. **Load Scene** button – Displays a pop-up with a list of available scenes.
11. **End Date** button – Displays a pop-up to set the date on which the event will no longer occur.
12. **Repeat** button – Displays a pop-up to select when the event repeats. Options are:
 - a. **No Repeat** – one-time event
 - b. **Daily** – seven days per week
 - c. **Weekdays** – Monday – Friday
 - d. **Weekly** – one time per week beginning on the Start Date
 - e. **Weekends** – Saturday and Sunday only
13. **Delete** button – Deletes the selected Event.



Menu – Controllers

Navigates to a screen where you can manage the MFCs. An MP-M can support up to 8 MFCs. You may assigned a unique set of functions to each one.

1. **Controllers** – Displays a list of 8 “virtual controllers”. Touch a controller name to setup or edit its functions. The default names are Controller 1 – 8.
2. **MFC Name** – Touch to display a keyboard you can use to enter a name for the virtual controller.
3. **Pair** – Touch this button to pair a virtual controller with a physical controller. A message displays on all connected controller screens “Press a switch to pair this device [Device ID].The mixer waits for a button push from an MFC.
The first MFC button push pairs that physical controller with the virtual controller. The app will display a pop-up message indicating successful pairing.

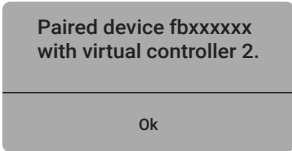

Touch Menu



Touch MFC Controller

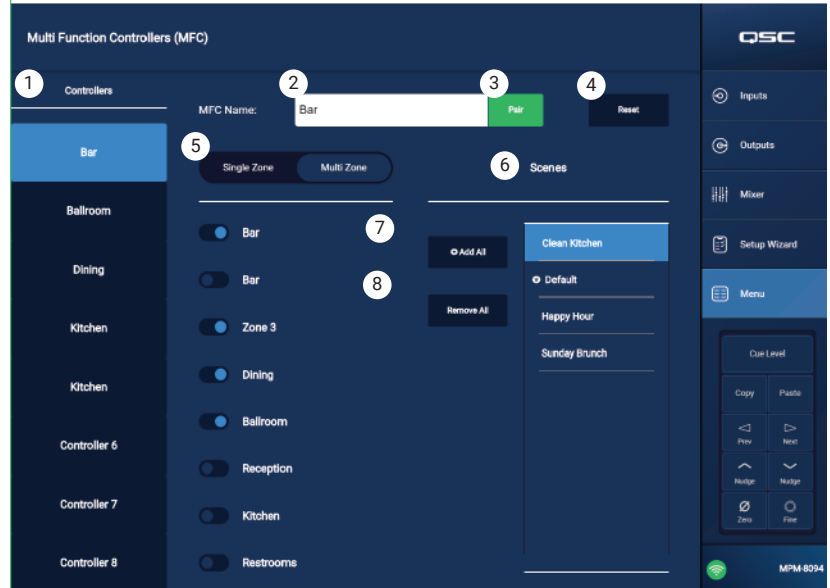

4. **Reset** – Returns the controls for the selected controller to factory default settings.
5. **Zones** – Single Zone / Multi Zone - Select whether the controller can address a single zone or multiple zones. In Single Zone mode, only one zone may be assigned to the controller. In Multi Zone mode, any or all of the zones may be assigned to the controller.
6. **Scenes** – This is a list of all the scenes on the mixer. Scenes in the app or USB do not display in this list. Use the scrollable list to select which scene or scenes the paired controller can recall. Assigned scenes are indicated by a star icon next to the scene name. Touch a scene name to assign or unassign.
7. **Add All** – Selects all stored scenes making them available to the paired controller.
8. **Remove All** – Removes all stored scenes from the list of scenes available to the paired controller.

Menu – Smartphone

Use Smartphone Access Profiles to define access groups for controlling which functions wireless devices can access with the MP Manage app.

For example, a manager may be given access to all MP Manage functions while a bartender may be limited to just control over the source and level for the bar area. Up to 8 Smartphone Access Profiles can be created.

1. **Profiles** – Displays a list of 8 smartphone profiles. Touch a Profile Name to set up or edit its functions. By default, the names are Profile 1 – 8
2. **Profile Name** – Touch to display a keyboard for entering a name for the profile.
3. **Save** – Saves the setting that have been made for the selected profile.



IMPORTANT: Make sure the selected Profile is saved before moving to the next Profile.

4. **Zones** – Select the zone or zones you want the profile to control.

Access Options

5. **Paging** – Enables the wireless Store-and-Forward paging function.
6. **Scheduler** – Enables access to the Event Scheduler.
7. **Recall Scenes** – Gives the profile the ability to Recall Scenes.
8. **Save Scenes** – Gives the profile the ability to save Scenes with changes.
9. **Security** – Gives users with access to this profile the ability to grant access to other users.
10. **Lock Zones** – Gives users the ability to lock a zone so that a scene recall won't change the zones setting. This would be useful to (for example) prevent a scheduled scene recall from interrupting an event.
11. **Mixer** – Enables access to the mixer.
12. **USB Player** – Enables access to the USB player track list and transport controls

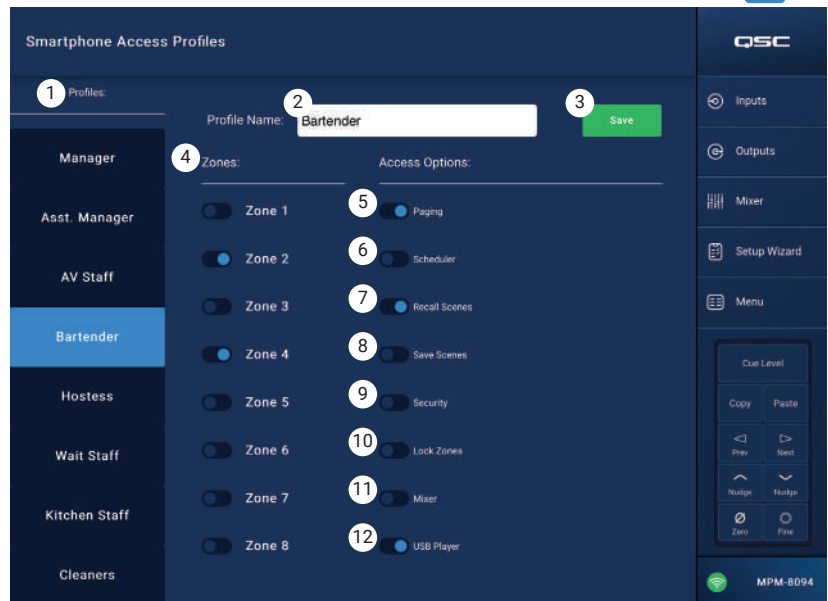

Menu - GPI Setup

The General Purpose Input (GPI) is used to recall Scenes using a (hardware) switch connected to the rear panel of the MP-M. There are two GPIs.

To use the GPI, at least one Scene must exist.

In the diagram, the condition of GPI 1 is open, and the condition of GPI 2 GPI-1 | GPI-2 is closed.

1. **GPI 1 Open** (or GPI 2 Open) – Recalls the Scene associated with the GPI 1 Open when the switch attached to GPI 1 is opened.
2. **GPI 1 Close** (or GPI 2 Close) – Recalls the Scene associated with the GPI 1 Close when the switch attached to GPI 1 Open is closed.
3. **Action Name** – The name of the Scene to be recalled when the condition of open or close is satisfied.
4. **Disabled / Recall** switch – Enables or disables the selected condition.
5. **Reset** – Resets the selected condition; no scene selected, and the Recall / Disabled switch to Disabled.
6. **Recall Scene** list – Displays the list of scenes created in the MP-M.

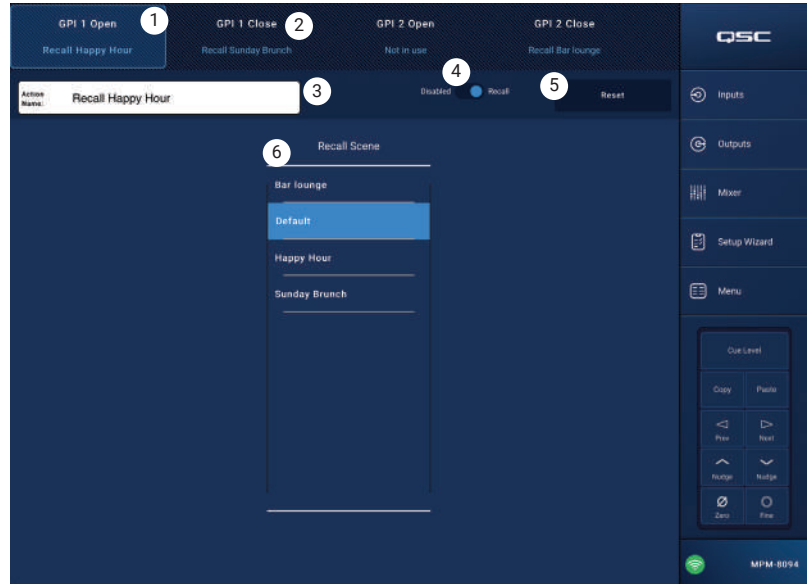
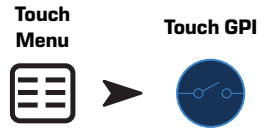
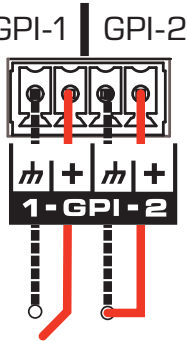

To Setup the Recall Conditions

- a. Select one of the following: GPI 1 Open, GPI 1 Close, GPI 2 Open, or GPI 2 Close.
- b. From the Recall Scene list, select a Scene to be recalled.
- c. Set the Disabled / Recall switch to Recall.

Menu – Report

Use this screen to enter information identifying the installation location, installer name and facility contacts.

Report Format

The report will be saved as an ASCII text file so that it can easily be copied and pasted into other documents. The following sample report is abbreviated to fit the page.

Installation Completed: 7 Nov 2018 1:25pm

1. **Work Order:** B9876543210
-----Location-----
2. **Job Site:** Rock and Rolls Pastry Pub
3. **Address:** 1234 Main Street, Anytown, 33516
4. **Primary Contact:** Joe's Wife
5. **Primary Contact Phone:** 800.555.1212
6. **Secondary Contact:** Joe's Brother
7. **Secondary Contact Phone:** 900.555.1212
-----Installed by-----

8. **Installer:** Joe
9. **Company:** BG-Musico, LLC
-----System Information (auto-entered)-----

-----Input Channels-----

Input 1 Name: In 1
.....THROUGH.....

Input 16 Name: Line In 16

-----Output Channels-----

Output 1 Name: Zone 1

Output 1 Sources:

1. In 1	2. In 2	3. In 3	4. In 4
5. In 5	6. In 6	7. In 7	8. In 8

.....THROUGH.....

Output 8 Name: Zone 8

Output 8 Sources:

1. Line In 16	2. In 2	3. In 3	4. In 4
5. In 5	6. In 6	7. In 7	8. In 8

----- Multi-Function Controllers (MFC)-----

MFC 1 Name: Controller 1

.....THROUGH.....

MFC 8 Name: Controller 8

-----Smartphone Profiles-----

Profile 1 Name: Manager

.....THROUGH.....

Profile 8 Name: Staff 6

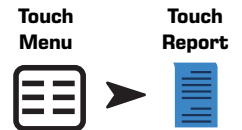

-----GPI Settings-----

- GPI 1 Action When Open: Not in use
- GPI 1 Action When Closed: Not in use
- GPI 2 Action When Open: Not in use
- GPI 2 Action When Closed: Not in use

-----Setup Wizard Checklist-----

- Load Configuration File : Incomplete or not applicable
- Enter Job Information : Incomplete or not applicable
- Name & Link Inputs : Incomplete or not applicable
- Name & Configure Outputs : Incomplete or not applicable
- Assign Sources : Incomplete or not applicable
- Load Speaker Tunings : Incomplete or not applicable
- Adjust Input Settings : Incomplete or not applicable
- Adjust Output Settings : Incomplete or not applicable
- Setup MFC : Incomplete or not applicable
- Setup Smartphone Controllers : Incomplete or not applicable

Setup Wizard Completion: 0%

-----End-----

10. **Generate Report** button – When the Generate Report button is touched, the MP-M will populate the rest of the report with data from its settings and open a window with options for saving or emailing the report.

Menu – System Test

The System Test screen is a setup and trouble-shooting tool used to send test signals to the MP-M outputs.



1. **Source / RTA** –
 - a. When **Source** is selected, a screen is displayed with options for selection of signal sources and outputs to test.
 - b. When **RTA** is selected a Real Time Analyzer is displayed.
2. **Source Input / Pink Noise / Sine Wave** –
 - a. Select **Source > Input** to use an Input as the test signal source.
 - i. Select **Source > Input > Input** to choose the MP-M Input to be used as a test signal source.
 - ii. Select **Source > Input > Gain** to adjust the level of the Input test signal.
 - b. Select **Source > Pink Noise** to use Pink Noise as the test signal source.
 - i. Select **Source > Pink Noise > Gain** to adjust the level of the Pink Noise test signal.
 - c. Select **Source > Sine Wave** to use a Sine Wave as the test signal.
 - i. Select **Source > Sine Wave > Frequency** to adjust the frequency of the Sine Wave test signal.
 - ii. Select **Source > Sine Wave > Gain** to adjust the level of the test signal.
3. **Select Output(s)** – Selects which output or outputs will receive the test signal.
4. **Enable** – Toggles the test signal on and off.
5. **Meter** – Displays the output level of the source.
6. Select RTA –
 - a. Select **RTA > Inputs** – Select any input to view an RTA display of the input's pre-EQ signal.
 - b. Select **RTA > Outputs** – Select any output to view an RTA display of the output's post-EQ signal.

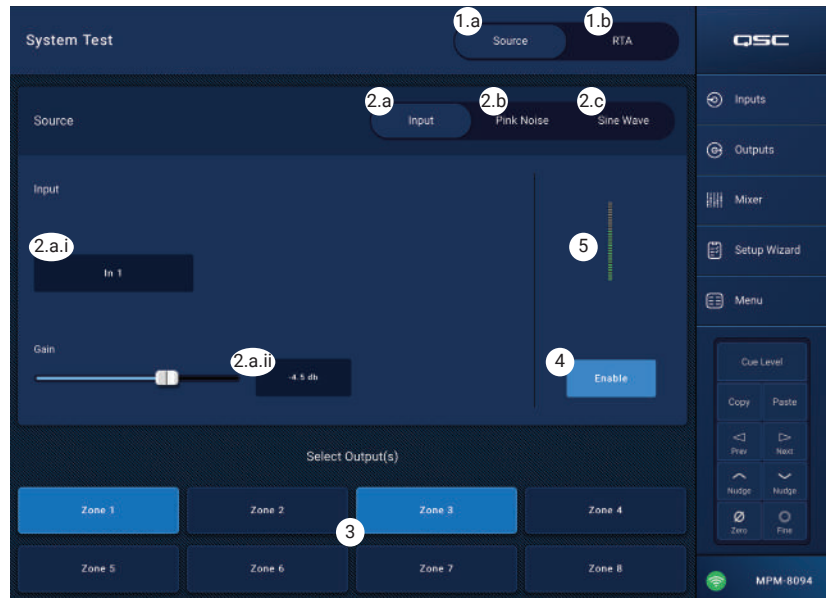

Menu – Network

USB Wi-Fi adapters

For short range applications with fewer potential sources of interference, an optional USB adapter, supplied by QSC, and available at – <https://parts.qsc.com/cp-000033-00>. No other USB Wi-Fi adapters have been qualified for use with the MP-M. Be aware that its range and connection reliability will be limited compared to an external Wi-Fi router.

If the optional QSC USB Wi-Fi adapter is installed, the mixer automatically creates its own network on power up. The factory-default network name will be “MPM-” followed by a random number. The mixer’s factory-default local network password is 1234509876.

Network Help button

Reset MP-M Network settings – Press the Network Help button to display the following information: If network connectivity is lost, it may be necessary to restore network settings to factory default values.

1. Push and hold the pinhole reset button (located to the right of the MFC jacks) for **10 seconds** to reset the MP-M network settings.
2. After 10 seconds, release the button and the fan will run briefly to indicate that this step is complete.
3. Power cycle the MP-M. To power cycle the MP-M, disconnect and reconnect AC power to the MP-M.
4. The MP-M network connection is reestablished.

Connecting to a Facility’s Network

Networks in commercial facilities have been set up by IT professionals who are concerned about security. They may be very reluctant to allow you to connect a mixer to their network. But if they do, they will want to know two things.

1. What port do you want them to give you? Answer – any open port will work. The mixer will find it.
2. What services do you need? Answer – none. The mixer implements zero-configuration networking using Bonjour®.

Menu – Wired Network Setup: Auto IP Address

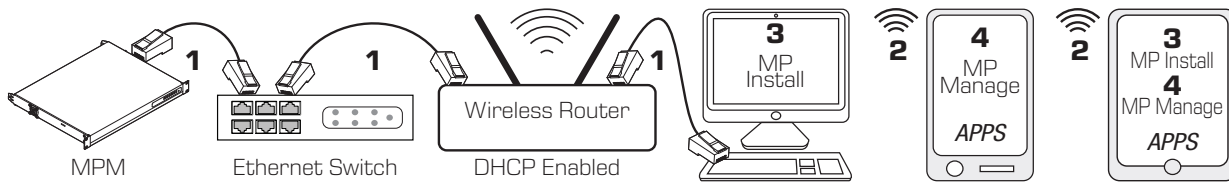

1 = wired Ethernet connection (RJ-45 connectors)

2 = wireless connection established between a wireless device and the wireless router

3 = MP Install running on PC and tablet device (MP Manage not available on a PC.)

4 = MP Manage running on a smart phone and tablet device (MP Install not available on a smart phone.)

Wired Ethernet connection – when an MP-M is wired to an Ethernet network (1) with DHCP enabled, the MP-M attempts to automatically obtain an IP address. If this isn't possible, the MP-M auto-assigns a link-local IP address.

The mobile devices join the network via the wireless router (2). (Refer to the manufacturer's instructions for devices (iOS, Android) connecting to a network.)

Once an IP address is established for the MP-M, and the devices with MP Install or MP Manage installed are connected to the network, the MP Install app and the MP Manage app can connect to the MP-M using the default passwords "Admin" (3) for MP Install and "Access" (4) for MP Manage. A strongly worded message displays encouraging the integrator to change the network and mixer passwords along with fields to enter the new passwords.

1. **Mixer Name** – Enter a name for the mixer. Press Enter to confirm the change.
2. **Network Type** – Set to Wired.
3. **Wired Network Settings** – Auto IP Address (DHCP)
4. **Assigned IP Address** – displays the IP Address supplied by the DHCP or the link-local address if the DHCP did not provide an address.
5. **Connection Status** – Displays the current status of the connection between the MP-M and the wireless router. Some possible readings are: Connected, Not Connected, Searching

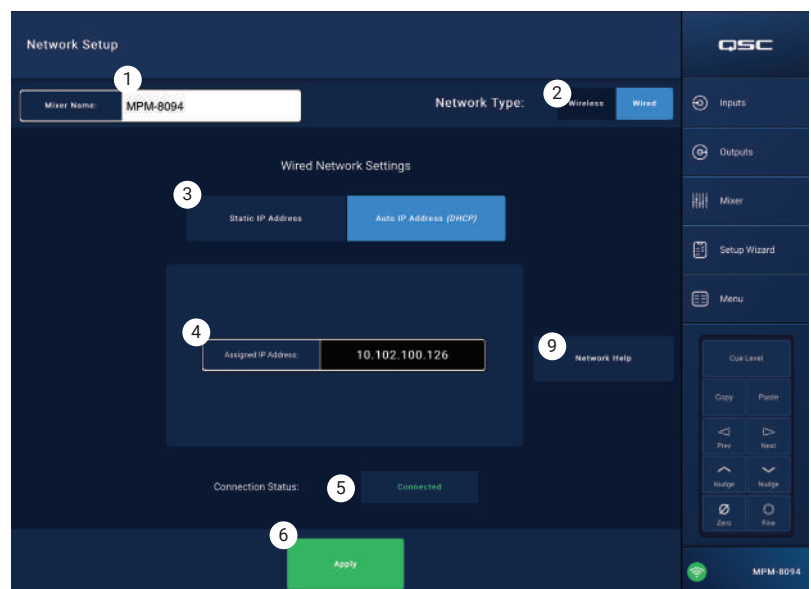
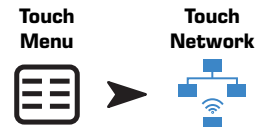

IMPORTANT! Make sure changes are confirmed for all text fields by pressing Enter while the cursor is in the field.

6. **Apply** – Touch to configure the mixer according to the network settings. A message "Wired Ethernet connection operational" displays.

NOTE: This step may take several minutes.

7. Touch **Okay**

The devices can now connect to the mixer via the wireless router.

- A device connects to the wireless router in the device's Wi-Fi settings using the router's SSID (name) and password. Refer to the remote device manufacturer's instructions for joining networks.
- When the device is connected to the wireless router, follow instructions to logon to the MP-M. .

Menu – Wired Network Setup: Static IP Address

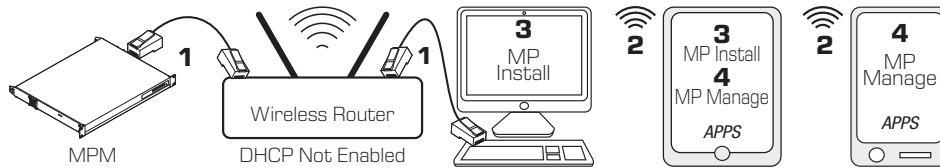

- 1 = wired Ethernet connections (RJ-45 connectors)
- 2 = wireless connection established between a wireless device and the wireless router
- 3 = MP Install running on PC and tablet device (MP Manage not available on a PC.)
- 4 = MP Manage running on a smart phone and tablet device (MP Install not available on a smart phone.)

 **IMPORTANT!** Connect an Ethernet wireless router to the mixer’s RJ45 jack.

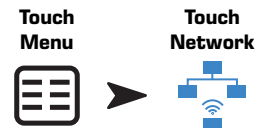



The **Wired Network Settings** with a **Static IP Address** (user selected) provides wired communications (1) between a MP-M and the wireless router. Make sure there is no other equipment connected to the same network with the same IP address.

The remote devices (smart phones, tablets) join the network via the wireless router (2). Refer to the device manufacturer’s instructions for joining a network.

Once the network is set up, and the remote devices have joined, the MP Install (3) and MP Manage (4) can log into the MP-M using the default passwords “Admin” for MP Install and “Access” for MP Manage. A strongly worded message displays encouraging the integrator to change the network and mixer passwords along with fields to enter the new passwords.

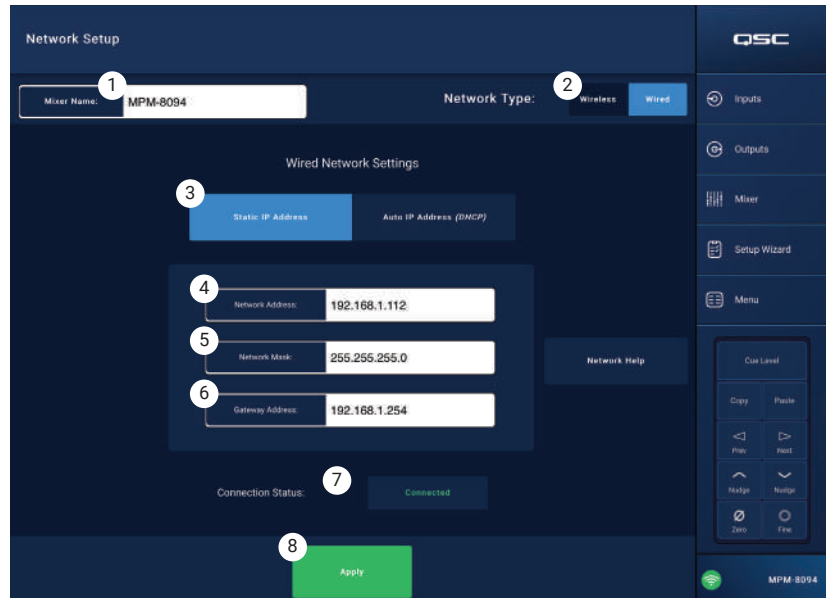
1. **Mixer Name** – Enter a name for the mixer. Press Enter to confirm the change.
2. **Network Type** – Set to **Wired**.
3. **Static IP Address** – Select to use a static IP address for the mixer.
4. **Network Address** – Enter the network address (i.e. Static Address) for the mixer. Press Enter.
5. **Network Mask** – Enter the network mask for the mixer. Press Enter.
6. **Gateway Address** – Enter the gateway address for the mixer. Press Enter.
7. **Connection Status** – Displays the current status of the connection between the MP-M and the wireless router. Some possible readings are: Connected, Not Connected, Searching
8. **Apply** – Touch to configure the mixer according to the network settings.



 **IMPORTANT!** Make sure changes are confirmed for all text fields by pressing Enter while the cursor is in the field.

8. **Apply** – Touch to configure the mixer according to the network settings.

 **NOTE:** This step may take several minutes.

The devices can now connect to the mixer via the wireless router.

- A device connects to the wireless router in the device’s Wi-Fi settings using the router’s SSID (name) and password. Refer to the remote device manufacturer’s instructions for joining networks.
- When the device is connected to the wireless router, follow instructions to logon to the MP-M. .

Menu – Wireless Network Setup: Create New Network

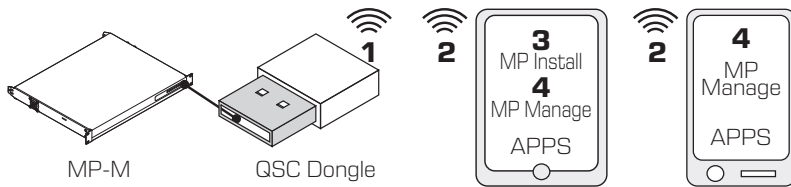

IMPORTANT! Requires the USB Wi-Fi adapter (QSC Part # cp-000033-00)

Create New Network using a USB Wi-Fi dongle provides short range wireless communication (1) between the MP-M and Android and/or iOS devices (2) with the MP Install (3) or MP Manage (4) app installed.

If the optional QSC USB Wi-Fi adapter is installed, the mixer automatically creates its own local network on power up. The factory-default local MP-M network name is “MPM-nnnn” (“nnnn” is a random number.) The mixer’s factory-default local network password is 1234509876.

1. **Mixer Name** – Enter a name for the MP-M Mixer. Press Enter to confirm the change.
2. **Network Type** – Set to **Wireless**.
3. Select **Create New Network**
4. **Set Password** – Enter a ten-digit (numerical) password. Press Enter to confirm the change.



IMPORTANT! Make sure changes are confirmed for all text fields by pressing Enter while the cursor is in the field.

5. **Apply** – Touch to configure the mixer according to the network settings. Remote devices may now join the mixer’s local network using the **Mixer Name** and **Password**. Refer to the remote device manufacturer’s instructions for joining networks.



NOTE: This step may take several minutes.

The devices can now connect to the mixer via the mixer’s network.

- A device connects to the mixer’s network in the device’s Wi-Fi settings using the mixer’s SSID (name) and password. Refer to the remote device manufacturer’s instructions for joining networks.
- When the device is connected to the mixer’s network, follow instructions to logon to the MP-M.

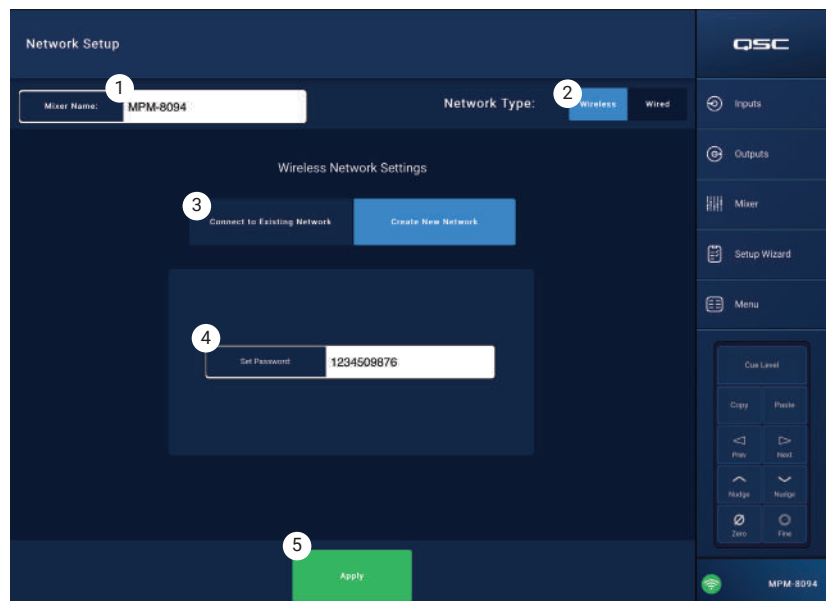
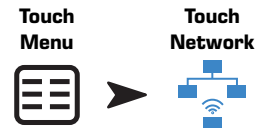

Menu – Wireless Network Setup: Connect to Existing Network

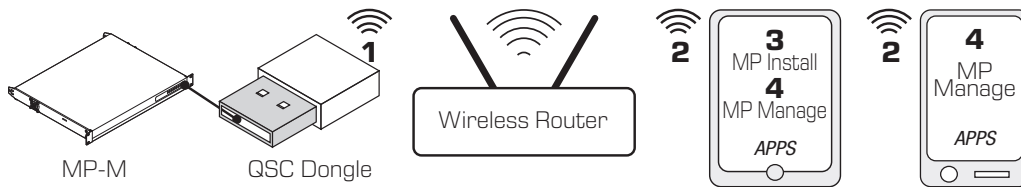

IMPORTANT! Requires an Ethernet Wi-Fi router and the USB Wi-Fi adapter (QSC Part # cp-000033-00).

Connect to Existing (Ethernet) Network using a USB Wi-Fi dongle provides short range wireless communication (1) between an MP-M mixer and a longer range wireless router. The Android and/or iOS remote devices with the apps, MP Install (3) or MP Manage (4) installed, communicate (2) with the MP-M via the wireless router.

1. **Mixer Name:** – Enter a name for the MP-M Mixer. Press Enter to confirm the change.
2. **Network Type** – Set to **Wireless**.
3. Select **Connect to Existing Network**.
4. **Network SSID** –
 - a. Enter a known SSID of an Ethernet wireless router. Press Enter to confirm the choice.
 OR
 - b. **Scan** – The mixer searches for, and displays, a list of available wireless routers. Select the desired wireless router.
5. **Password** – Enter the password for the wireless router network being joined. Press Enter to confirm the change.
6. **Security** – Select the Security setting used by the wireless router network.
7. **Signal Strength** – Displays an icon showing the strength of the wireless router signal.

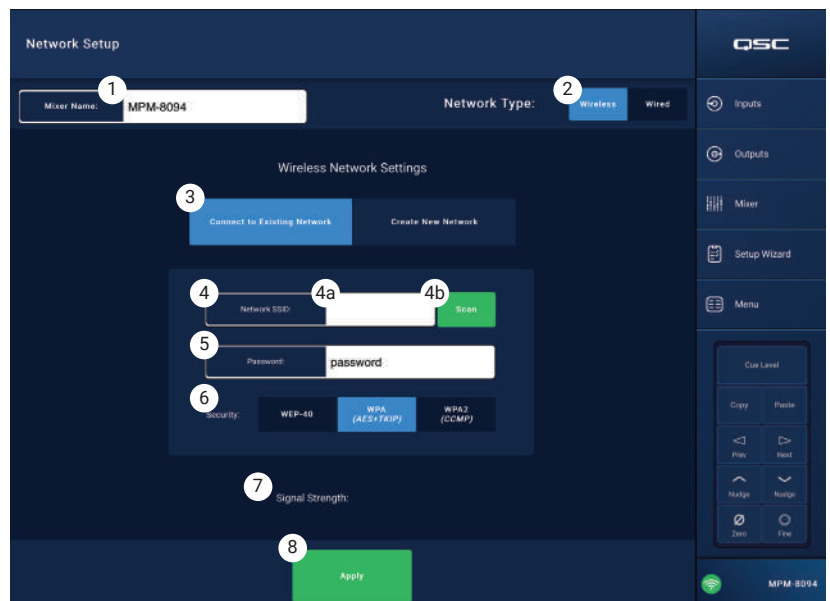
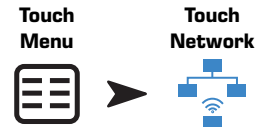

IMPORTANT! Make sure changes are confirmed for all text fields by pressing Enter while the cursor is in the field.

8. **Apply** – Touch to configure the mixer according to the network settings. The devices can now connect to the mixer via the wireless router.
 - A device connects to the wireless router in the device's Wi-Fi settings using the router's SSID (name) and password. Refer to the remote device manufacturer's instructions for joining networks.
 - When the device is connected to the wireless router, follow instructions to logon to the MP-M.

Menu – Security

Security Setup is used to change the **Admin Passwords** for the MP Install and MP Manage apps. The default passwords are shown in the image below. These should be changed to prevent unauthorized access.

Touch one of the **Set Password** fields to display a keyboard and enter a new password.

1. **MP Install** – The MP Install password allows access to and control of all MP-M functions.
2. **MP Manage** – The MP Manage password allows access to the functions that let a manager grant access to users of smartphones with the MP Manage app installed. See the MP Manage and Smartphone sections of this document for more detail.
3. **MP External Control** – The MP External Control password allows a control system to authenticate with the MP-M for external control via Ethernet using its API.

Staff Access Management

The first staff member to access the mixer with MP Manage app must use the manager password that was entered by the installer. If the password is forgotten, use the reset procedure to return the passwords to the factory defaults. From then on, the associated device is authorized for all access.

Reset Passwords

If Installer and Manager passwords are lost, they may be reset to the factory programmed defaults by pushing and holding the “Reset” pin-hole switch (located next to the MFC RJ-45 jacks) for **2 seconds**.

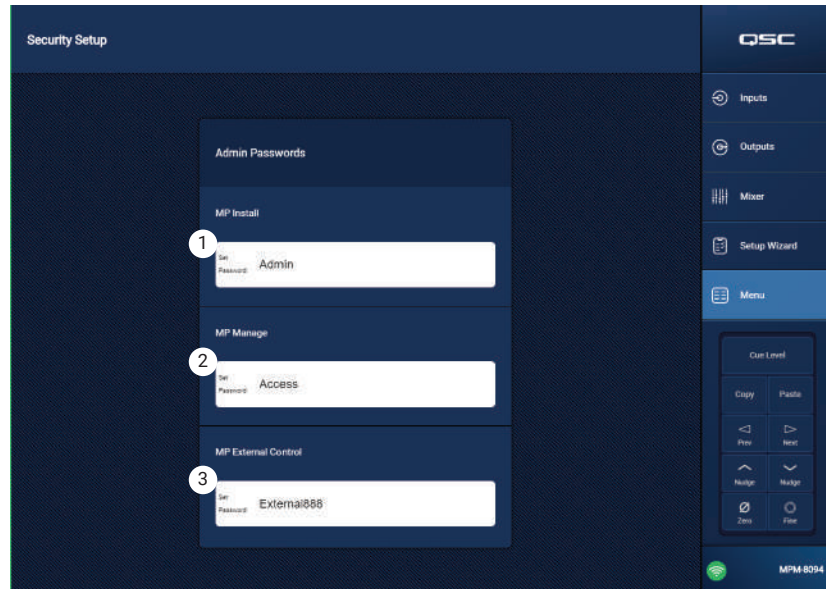

Menu – Settings

1. **USB playback** – Enables or disables the ability of the MP-Manager app to play audio files from a USB storage device. When disabled, USB playback controls are not displayed in the MP Manager app.

Mixer Time:

The MP-M has an internal real time clock that is used with the Scheduler to schedule scene recall events.

2. **Time** – Displays the date (DD-MM-YYYY) and time (hh:mm:am/pm).
3. **Time Zone** button – Touch to display a listing of time zones. Touch the time zone in which the mixer is located.
4. **Sync MP-M to App Time** button – Touch to sync the MP-M time to the connected device's time.

Storage and Log:

5. **Save System Log to USB** button – Touch to save a log that may be useful to QSC technicians for troubleshooting purposes.



CAUTION!: Formatting a drive removes all data stored on the drive. Make sure there are no valuable files on the drive.

6. **Format USB Drive** button – The MP-M requires a FAT32 format USB drive for upgrades and for Configuration, Scene and Preset files. This button provides an easy means of applying a FAT32 format to a storage device installed in one of the MP-M USB ports.
7. **Clear Internal Storage** button – Clears all user presets, user scenes and remote device access settings from internal memory. A confirmation dialog displays.

Software:

The Software section is used to check the currently installed firmware version and to perform updates.

8. **End User License Agreement** button – Touch to display and read the End User License Agreement.
9. **Reset Mixer** button – Restores MP-M settings to factory default values.
10. **Version** – Displays the number of the currently loaded firmware version.
11. **Download Upgrade** button – Touch to check for and download the upgrade file. If the MP-M is connected to the Internet, it can check for software versions newer than that currently installed. In order to download the software, a FAT32 USB drive with at least 1 GB of available memory must be connected to one of the MP-M USB ports.
12. **Upgrade** button – Touch to begin the process of upgrading the MP-M firmware. A FAT32 format drive with the upgrade firmware is required.



NOTE: There is no automatic check for newer versions. Checking for upgrades must be manually initiated.

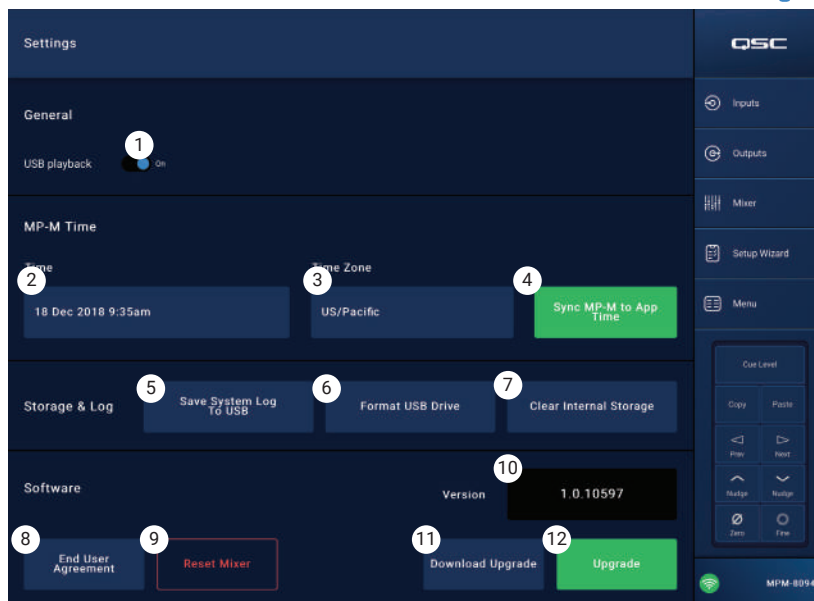
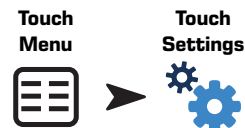

Multi-Function Controller

The controller controls volume, source, and scene selection with the available parameters and limits that were assigned to the zone during setup.

Setup

Refer to Menu – Controllers.

Operation

Starting from Sleep mode:

Pushing any button wakes the MFC but does nothing else. Upon waking, the MFC displays the following based on how it was configured by the installer.

- MFC friendly name as defined during MFC setup.
- Current Source (friendly name) To select a different source:
 - a. Press Enter, a list of available sources display.
 - b. Use Up and Down buttons to highlight a new Source.
 - c. Press Enter to finalize selection.
- To select a new Scene:
 - a. Press Enter two times, a list of available Scenes display.
 - b. Use Up and Down to highlight a new Scene or "EXIT".
 - c. Press Enter to finalize selection.
- To adjust the Volume:

With the Volume indicator visible, use the up and down buttons to make the change.

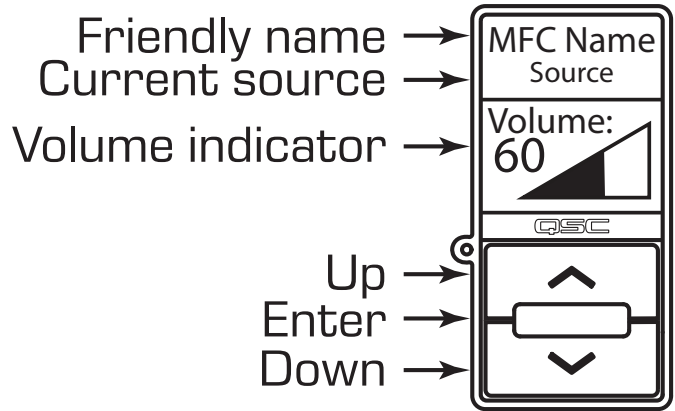

MP Manage

MP Manage – Security

The Music & Paging Manager App (MP Manage) is a stand-alone app for use by facility manager and staff. The MP Manage app may be run on tablet devices or smartphones. The MP-M installer may create up to eight Smartphone Access Profiles. Each Profile can include access to any combination of MP Manage functions (described below). These functions may relate to a staff position or an area of the facility.

Devices cannot control the MP-M unless they are granted access by a user who has logged in as Manager. In order to access the Manager profile, the user must log in using a password that was created by the Installer.

Log in as Manager

1. Connect an Android or iOS device to the Wi-Fi network used by the MP-M.
2. Launch the MP Manage app.
3. A connection confirmation pop-up displays. Touch OK
4. Touch the Password button and enter the Manager password provided by the installer.
5. Touch the Security button.
6. Make sure that the name of the smartphone or tablet (A) is highlighted on the right of the screen.
7. Select Manager (B) from the Access Profiles list.
8. Touch the Save Access button (C) and a pop-up displays with a list of the other functions that the installer included in the Manager Access Profile. Touch OK to begin using MP Manage.

Add a New User

No password is required for other users. However, new users will not be able to use MP Manage functions until a Manager grants access.

To log in using a new device:

1. Connect to the Wi-Fi network used by the MP-M:
2. Launch the MP Manage app.
3. A pop-up displays on the new device indicating that “You are connected to MPM-xxxx and have access to: No Access has been granted yet. OK”
4. If there is a device logged in as Manager, having access to Security, a pop-up displays indicating that “A new device [DEVICE NAME] has connected to the mixer. See Security in MP Manage to grant access.”

On the Manager’s device:

5. Touch OK to dismiss the message.
 6. If prompted, enter the Manager password.
 7. Touch the Security button
 8. Make sure that the name of the new device is highlighted on the right of the screen.
 9. Select an Access Profile
 10. Touch the Save Access button and a pop-up displays with a list of the functions that the installer included in the selected profile.
- The new user’s device displays a message indicating which functions they may access and they can begin using MP Manage.

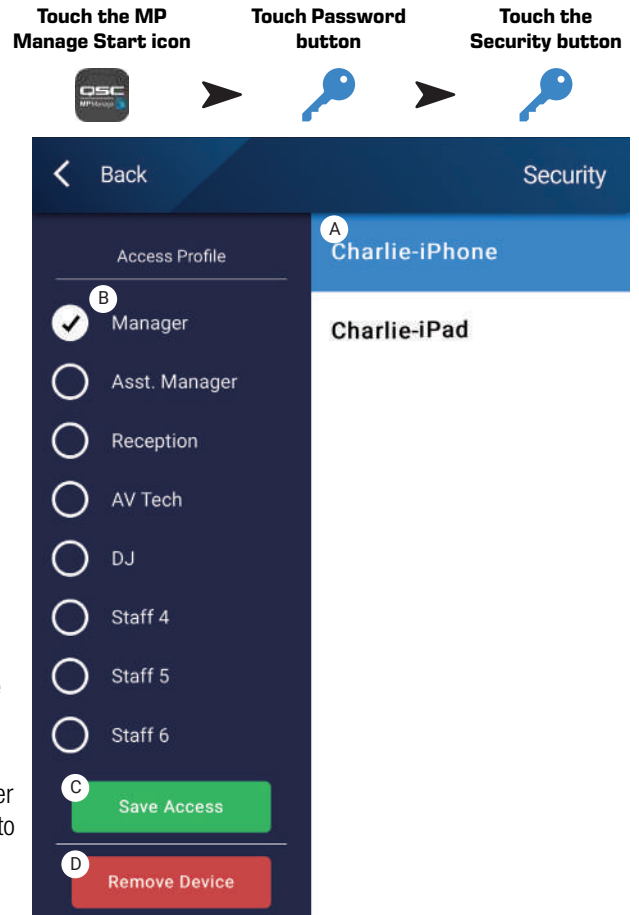

MP Manage – Home Screen

The Home screen provides links to the functional areas available to connected devices. The following list provides brief explanations of the items accessed through this screen.

1. **Zones** – Change the Source, Volume, and Lock/unlock the zone.
2. **Scheduler** – Add new scheduled events, Modify scheduled events, Delete events, and Sync the MP-M time to the App time.
3. **Scenes** – Recall and Update Scenes.
4. **Security** – Manage access profiles.
5. **Player** – Operate the USB Player. Select files to play, start and stop play, and change play mode.
6. **Mixer** – Mute mixer channels and set mixer channel volume.
7. **Paging** – Record Page, Preview Page, and Send Page.

Touch the MP
Manage Start icon



MP Manage – Zone Overview

The Zone Overview screen shows high-level settings for all zones on a single screen as well as links to individual zones.

1. **Zones** – Displays the zone number
2. **Friendly Name** – User-defined name of the zone.
3. **Source** – The current input source selected for the zone.
4. **Volume** – Touch and drag the fader to adjust the zone volume.
5. **Lock** – The current lock status of the zone. When a zone is locked, the zone is protected by zone controls or scene recall. The user must have Lock Zones access allowed in the access profile to lock or unlock a zone. A lock icon displays when the zone is locked.

Zones that are not available to the user are grayed out.



MP Manage – Zone Edit

To access the Zone Edit screen, touch one of the zones on the Zone Overview screen.

1. Back button – Return to the Zone Overview screen.
2. Friendly Name – User-defined name of the zone.
3. Source – Displays the current source for the Zone. Touch to select a different source from the list of available sources.
4. Digital readout – Displays the current position of the volume fader.
5. Volume fader – Touch and drag the fader to adjust the zone volume.
6. Level meter – 3-segment LED (Green, Yellow, Red) showing the overall zone output volume.



MP Manage – Scheduler

Displays a list of scheduled events. Up to 32 events may be scheduled. A Scene is recalled when a scheduled event occurs. Each event is displayed as a row with these settings:

1. **Back** button – Returns to the Home screen.
2. **Event Name** – The name of the scheduled action.
3. **Start** – The day, date and time on which the action occurs for the first time.
4. **Active** indicator –
 - a. Green – The event will occur at the designated time.
 - b. Red – The End Date/Time for the event is in the past but the settings are preserved. Or the Active switch has been manually set to Inactive.
5. **New** – Touch to create a new event. A new event is placed in the event list, touch Modify to setup the event.
6. **Modify** – Edit the settings of the selected event.
7. **Delete** – Delete the selected event.
8. **Settings** – Sync the time on the MP-M to that of the app. Touch close when you are finished.

Touch Scheduler

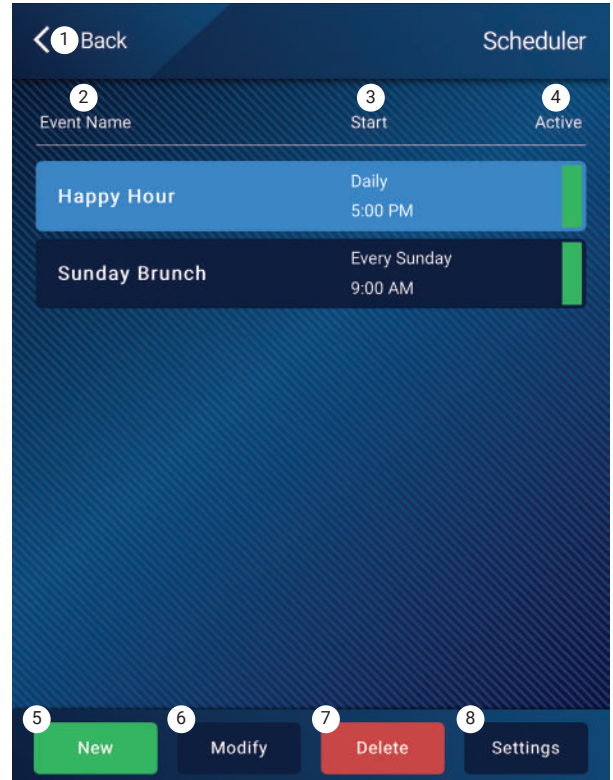

To Modify an Event (New or Existing)

Select the event to be modified and touch Modify. The Modify Event screen displays. The following controls are available.

1. **Back** button – Touch to return to the Event Scheduler home screen.
2. **Event Name** – Touch the field, a keyboard displays. Enter a new name.
3. **Active** switch – Touch the Active switch to indicate that the event will take place as set up.
4. **Start Date** – Touch the start date to open a calendar-selection dialog where you can set the Month, Day, and Year the event is to start. Touch done to close the dialog.
5. **Start Time** – Touch the start time to open a time-selection dialog where you can set the the time in Hours, Minutes, Seconds, and AM/PM the event is to start. Touch done to close the dialog.
6. **Load Scene** – Touch Load Scene to designate the scene to be recalled when the start time and date are reached. Touch enter to close the dialog.
7. **End Date** – Touch the end date to open a calendar-selection dialog where you can set the Month, Day, and Year the event is to end. Touch done to close the dialog.
8. **Repeat** – Touch Repeat to select the occurrence frequency of the event. Choices are No repeat, Daily, Weekly, Monthly, Weekdays, and Weekends. Touch done to close the dialog.

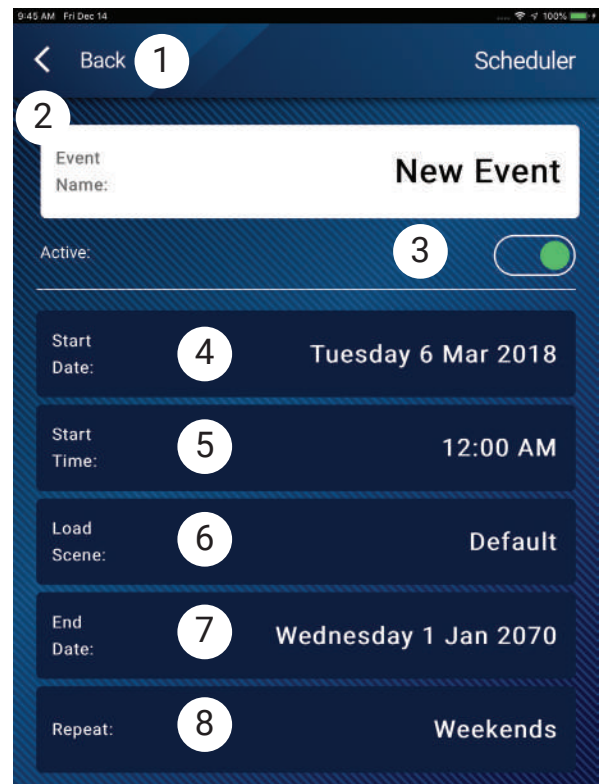

MP Manage – Scenes

This screen is used to recall scenes (Presets) from a menu. The “Manage” function is only available to authorized devices. To recall a scene scroll and select from the list and touch Recall. A confirmation pop-up displays.

1. **Back** button – Returns to the Home screen.
2. **Select Scene to Recall** list – Select one scene from the list to recall.
3. **Update** button – Saves the currently active scene with any changes made since the scene was last saved. A pop-up displays with the zones affected by the scene.
4. **Recall** button – Recalls the selected scene.

Touch
Scenes

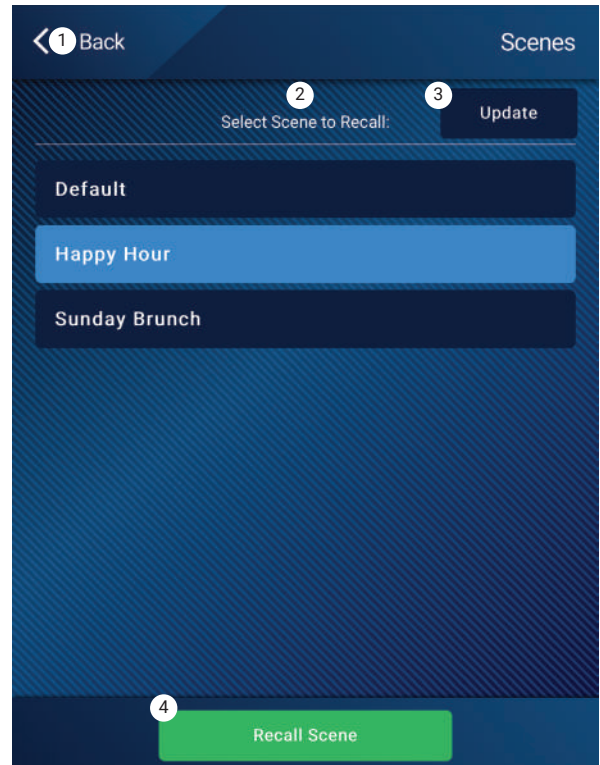

MP Manage – Player

Use the USB Player for MP3 playback from a USB storage device attached to one of the MP-M USB ports.

- The USB storage device must be formatted FAT32.
 - The audio files must be in the root directory.
 - Files are displayed in alpha-numeric order.
 - MP3 files must have a sample rate of 44.1k.
 - USB Playback must be enabled by the installer in order for this feature to be available for the MP Manage app.
1. **Back** button – Returns to MP Manage Home page.
 2. **MP3 Songs** – Displays a list of MP3 titles on the inserted USB drive.
 3. **Track** – Displays title of currently selected MP3 file.
 4. Playback Time – Indicates elapsed time since beginning playback.
 5. Duration – The total time of the file (must be playing).
 6. Position Progress – Touch, hold, and drag to desired position on the Progress Line.
 7. **Playback Mode** –
 - a. **Normal** button – plays the files in listed order (alpha-numeric)
 - b. **Shuffle** button – plays the files in random order.
 - c. **Single** button – plays the selected file one time. Does not repeat.
 8. Top-of-List – Touch to move to the beginning of the file list.
 9. Previous file – Touch to move to the previous file in the file list.
 10. Play – Touch to begin playback of the currently selected MP3 file.
 11. Next file – Touch to move to the next file in the file list.

Touch
Player

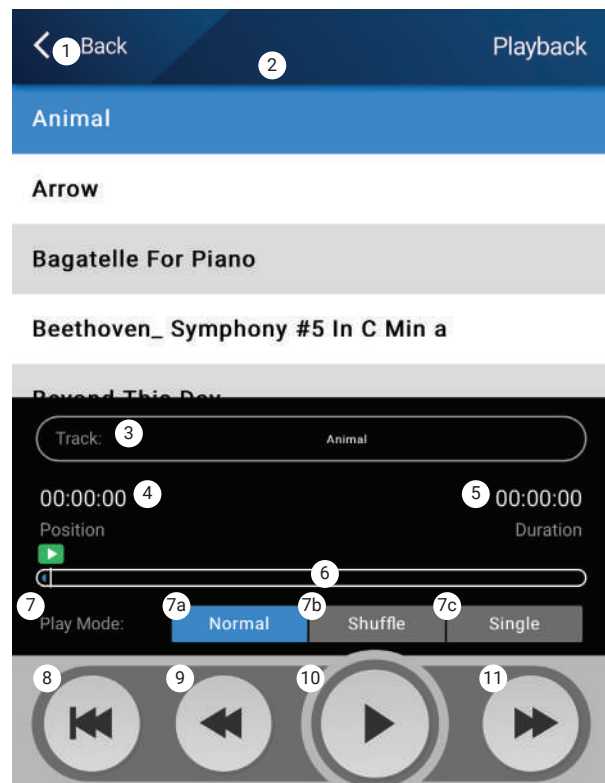

MP Manage – Mixer

This screen is used to adjust the levels of the Input channels going to the MP-M Internal Mixer and the output of the mixer. The mixer output can be designated as a source for the MP-M outputs.

1. Back button – Returns to the MP Manage Home screen.
2. Mute buttons – Mutes and un Mutes the associated channel.
3. Level faders – This is a scrollable list of Input Channels with their associated faders. The first item in this list is the Main Mixer L/R output fader. Touch and drag to set level.

Touch Mixer

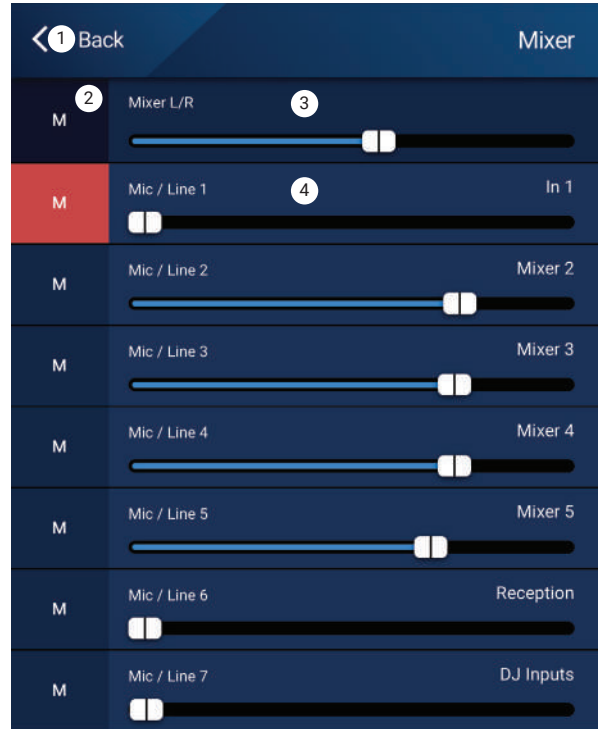

MP Manage – Paging



These screens are used to record, preview, and send pages over the MP-M system.

Make sure the tablet or smartphone is set up so that the MP-Manager app has access to the device's microphone.

Make sure that the Zones to receive the pages are set up so that WiFi Paging is a Priority Source to the Zones.

1. **Record Page** – Touch to start recording the page.
2. The **Recording** screen displays.
3. **Speak** the message. The progress bar moves to indicate recording is taking place.
4. **Stop / Exit Recording** – Touch to stop recording.
5. **Preview Page** – Touch to listen to the page.
6. **Progress** bar – Indicates progress of the recorded page. The audio plays back through the device.
7. **Stop Playback / Exit** – Touch to stop playback and exit the playback screen
8. **Send Page** – Touch to send the page over the system.
9. **Paging System In Use** – Displays to indicate the page is being played back over the designated zones.

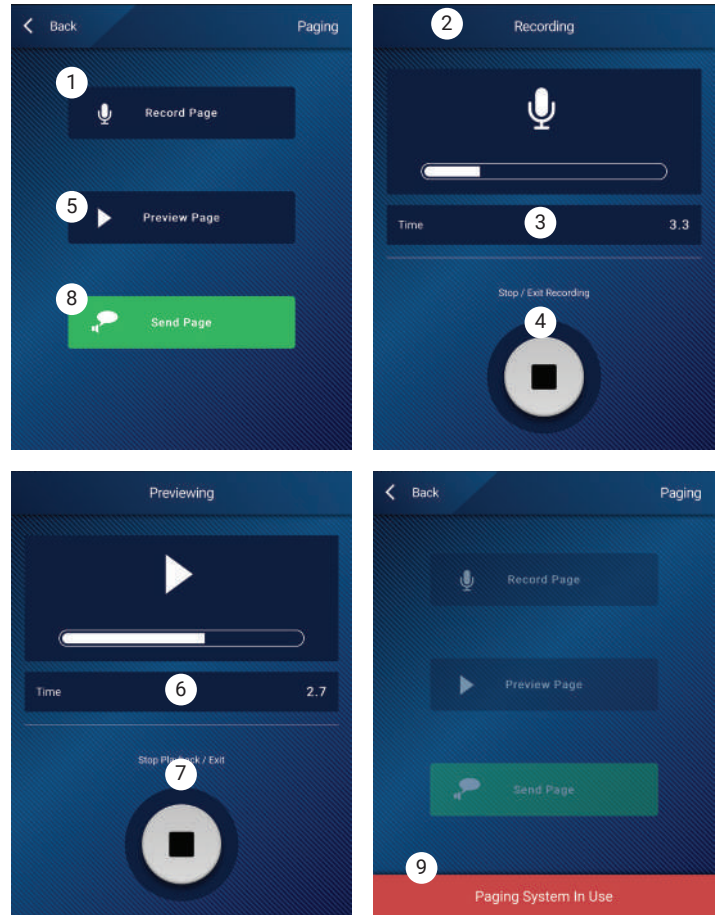

MP-M Dimensions

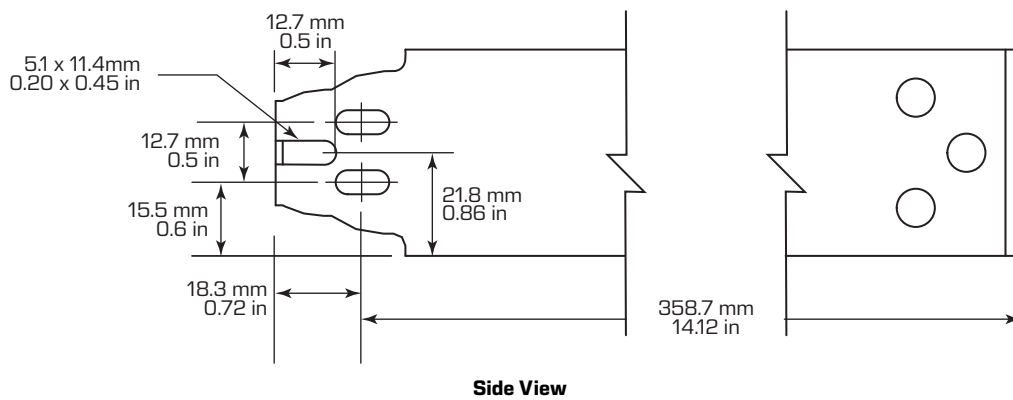
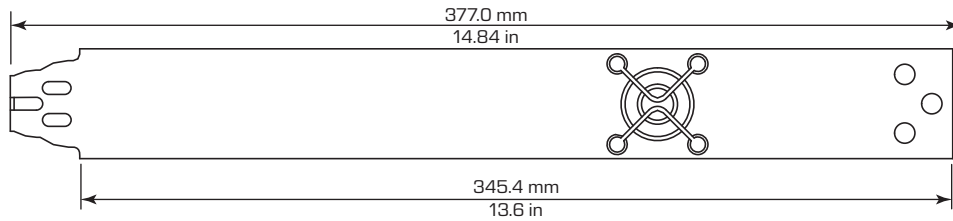
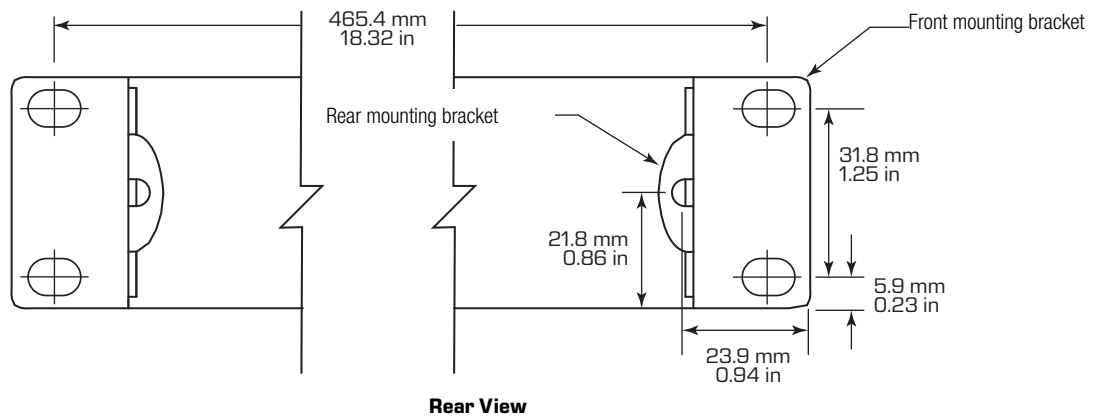
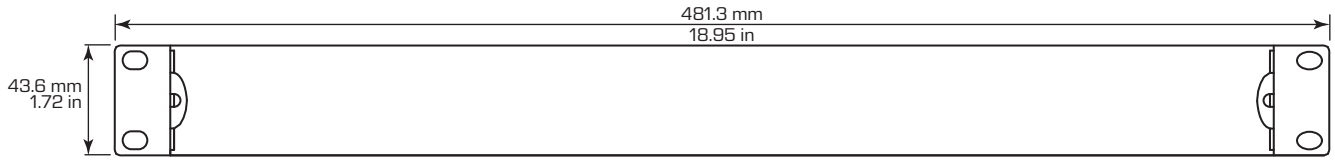

MP-M Block Diagrams

Mic/Line Input Channels & Auto Mixer

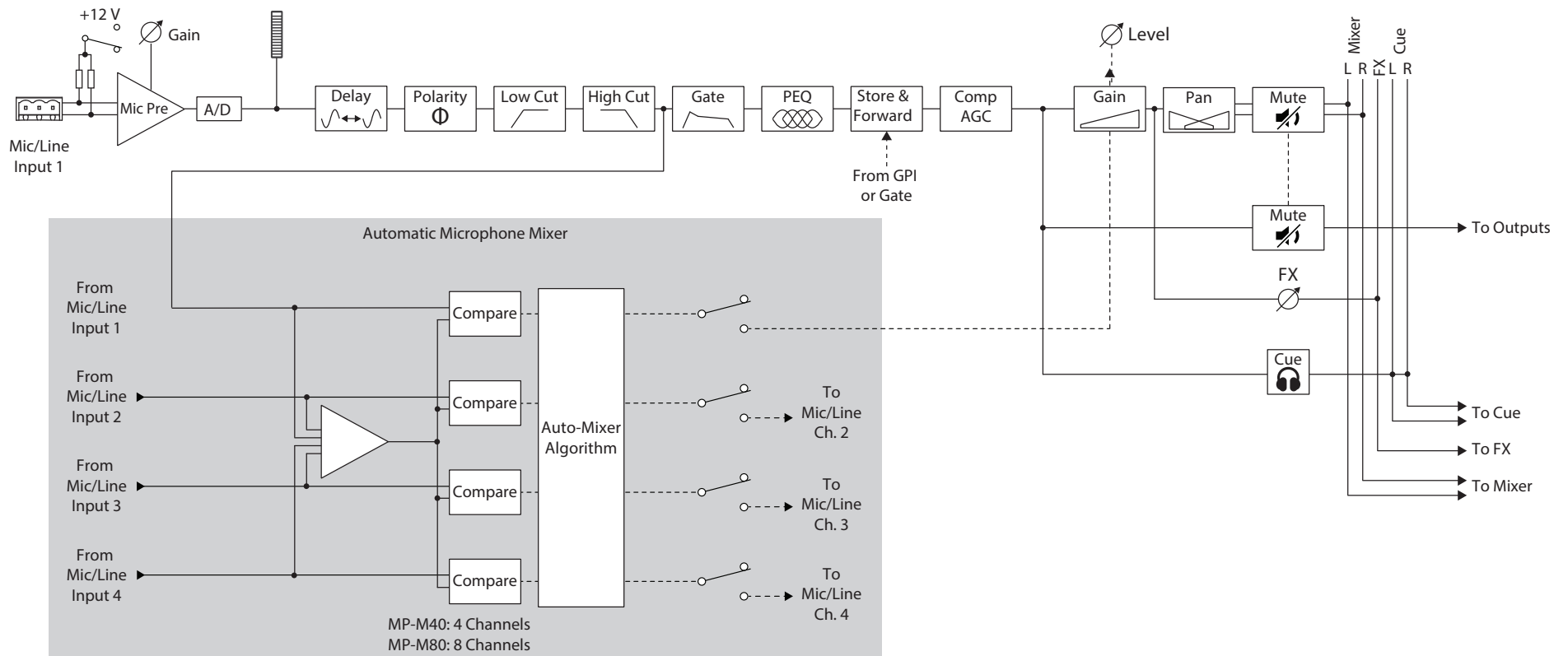

Line Inputs, USB Inputs, Music on Hold, Cue, Wireless Paging

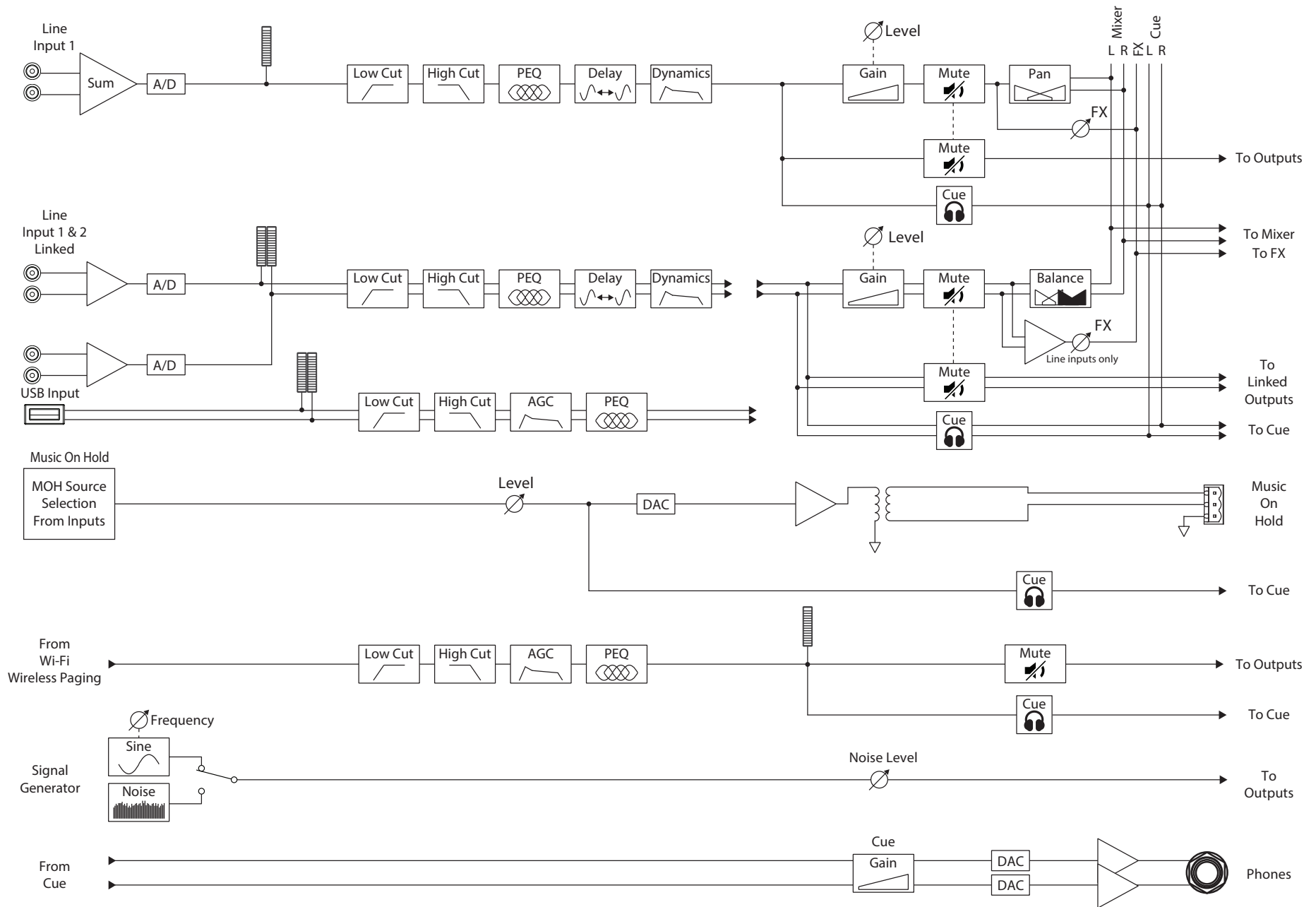

Mono Zone Output

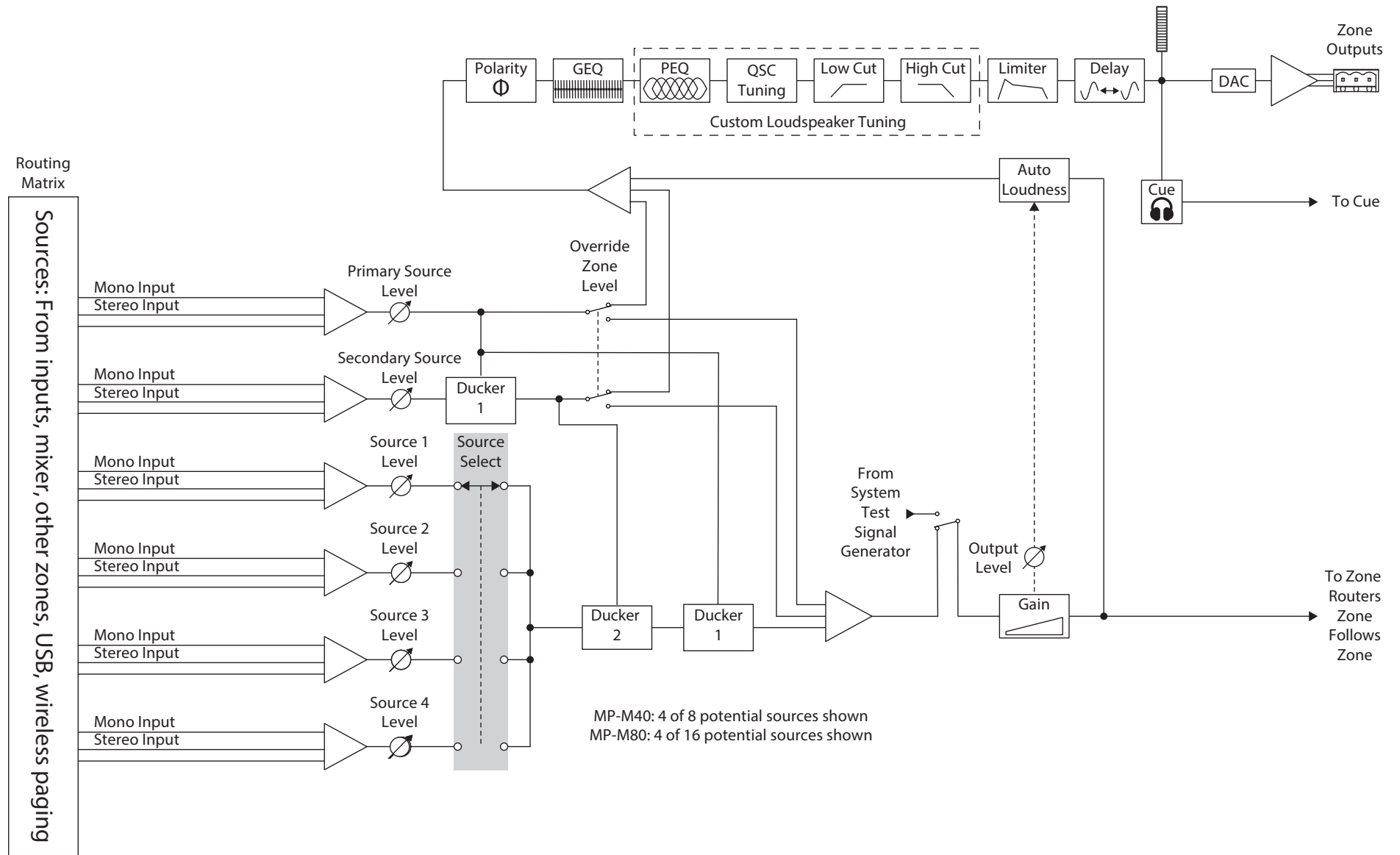

Stereo (Linked) Zone Outputs

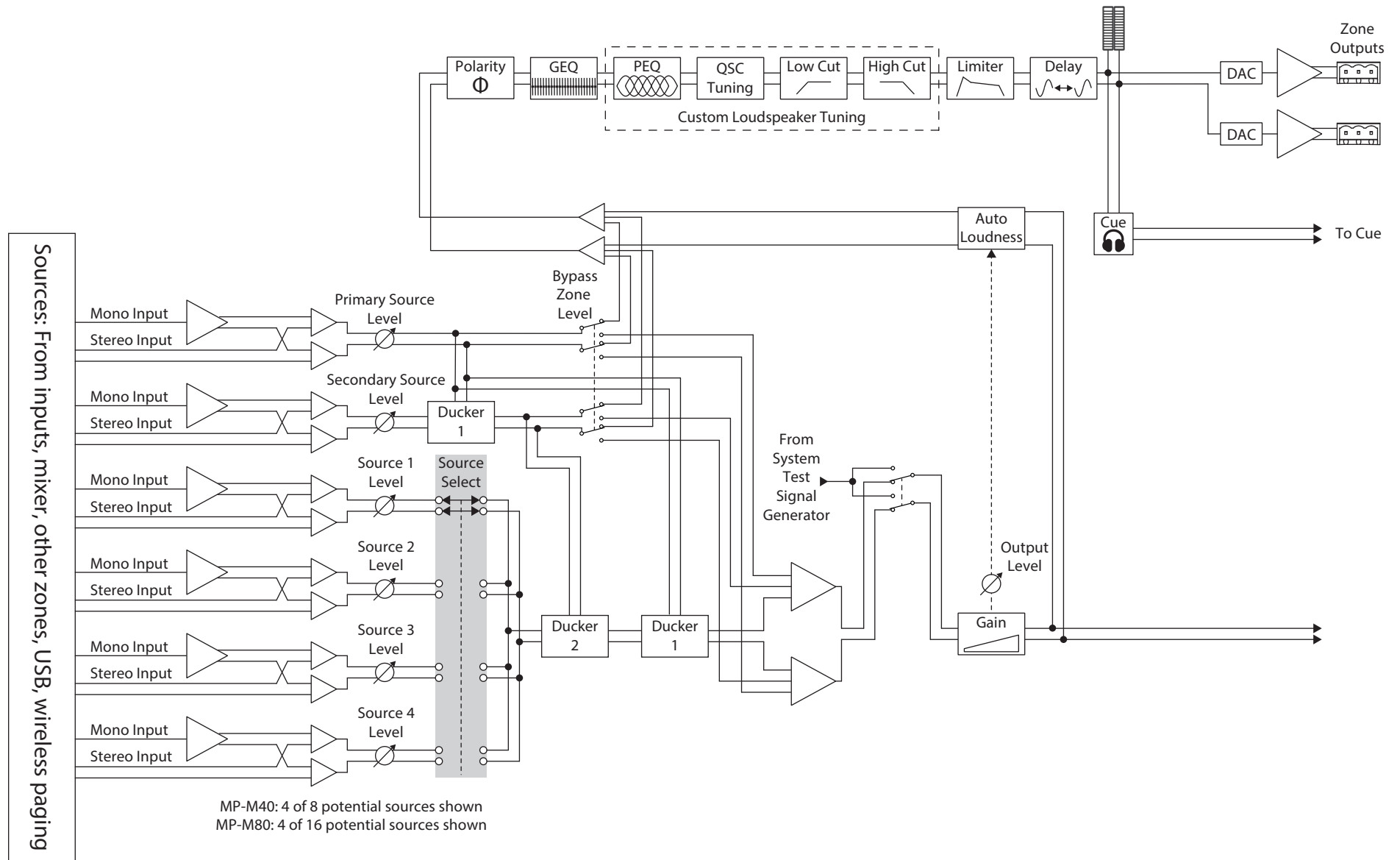

Mixer

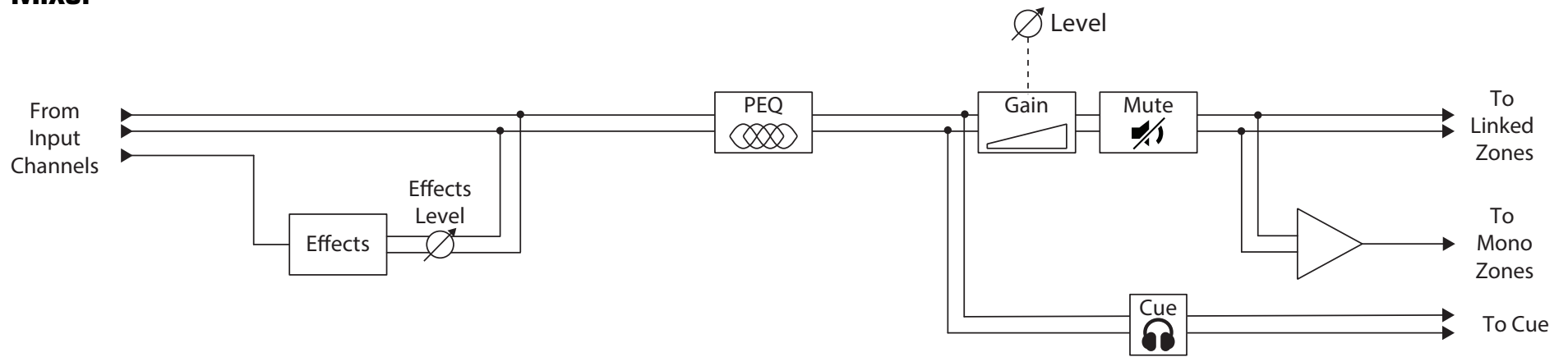



QSC, LLC

:Mailing Address MacArthur Boulevard 1170
.U.S 1478-9277 Costa Mesa, CA

:Main Number 1,714,704,7170+

:World Wide Web www.qsc.com

:Sales & Marketing

:Voice or 1,714,907,7100+
(toll free (U.S. only 1,800,804,4079

:FAX 1,714,704,7174+

:E-mail info@qsc.com

Customer Service**QSC**

:Mailing Address .MacArthur Blvd 1170
.U.S 9277 Costa Mesa, CA

:Voice 1,714,907,7100+
(toll free (U.S. only 1,800,772,2834

:FAX 1,714,704,7173+

:E-mail CinemaTechSupport@qsc.com
service@qsc.com
