

ALLEN & HEATH

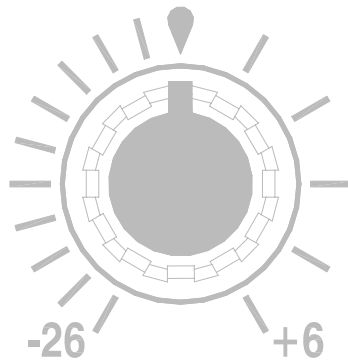

 **XONE:32**
P R O F E S S I O N A L D J M I X E R

USER GUIDE

Publication AP4264

Limited One Year Warranty

This product is warranted to be free from defects in materials or workmanship for a period of one year from the date of purchase by the original owner.

To ensure a high level of performance and reliability for which this equipment has been designed and manufactured, read this User Guide before operating.

In the event of a failure, notify and return the defective unit to ALLEN & HEATH or its authorised agent as soon as possible for repair under warranty subject to the following conditions

Conditions Of Warranty

1. The equipment has been installed and operated in accordance with the instructions in this User Guide
2. The equipment has not been subject to misuse either intended or accidental, neglect, or alteration other than as described in the User Guide or Service Manual, or approved by ALLEN & HEATH.
3. Any necessary adjustment, alteration or repair has been carried out by ALLEN & HEATH or its authorised agent.
4. This warranty does not cover crossfader wear and tear.
5. The defective unit is to be returned carriage prepaid to ALLEN & HEATH or its authorised agent with proof of purchase.
6. Units returned should be packed to avoid transit damage.

In certain territories the terms may vary. Check with your ALLEN & HEATH agent for any additional warranty which may apply.

 This product complies with the European Electromagnetic Compatibility directives 89/336/EEC & 92/31/EEC and the European Low Voltage Directives 73/23/EEC & 93/68/EEC.

This product has been tested to EN55103 Parts 1 & 2 1996 for use in Environments E1, E2, E3, and E4 to demonstrate compliance with the protection requirements in the European EMC directive 89/336/EEC. During some tests the specified performance figures of the product were affected. This is considered permissible and the product has been passed as acceptable for its intended use.

Allen & Heath has a strict policy of ensuring all products are tested to the latest safety and EMC standards. Customers requiring more information about EMC and safety issues can contact Allen & Heath.

NOTE: Any changes or modifications to the console not approved by Allen & Heath could void the compliance of the console and therefore the users authority to operate it.

XONE:32 User Guide AP4264 Issue 6

Copyright © 2004 Allen & Heath Limited. All rights reserved

ALLEN & HEATH

Allen & Heath Limited
Kernick Industrial Estate, Penryn, Cornwall, TR10 9LU, UK

<http://www.allen-heath.com>



Important Safety Instructions – Read First

- Read instructions:** Retain these safety and operating instructions for future reference. Adhere to all warnings printed here and on the console. Follow the operating instructions printed in this User Guide.
- Do not open:** Operate the console with its front and crossfader panels correctly fitted. Disconnect mains power by unplugging the power cord if a panel needs to be removed for servicing. Refer this work to competent technical personnel only.
- Power sources:** Connect the console to a mains power only of the type described in this User Guide and marked on the rear panel. The power source must provide a good ground connection.
- Power cord:** Use the power cord with sealed mains plug appropriate for your local mains supply as provided with the console. If the provided plug does not fit into your outlet consult your service agent for assistance. Route the power cord so that it is not likely to be walked on, stretched or pinched by items placed upon or against it.
- Grounding:** Do not defeat the grounding and polarisation means of the power cord plug. Do not remove or tamper with the ground connection in the power cord.
- Ventilation:** Do not obstruct the ventilation slots or position the console where the air flow required for ventilation is impeded. If the console is to be operated in a rack unit or flightcase ensure that it is constructed to allow adequate ventilation.
- Moisture:** To reduce the risk of fire or electric shock do not expose the console to rain or moisture or use it in damp or wet conditions. Do not place containers of liquids on it which might spill into any openings.
- Heat:** Do not locate the console in a place subject to excessive heat or direct sunlight as this could be a fire hazard. Locate the console away from any equipment which produces heat such as power supplies, power amplifiers and heaters.
- Environment:** Protect from excessive dirt, dust, heat and vibration when operating and storing. Avoid tobacco ash, drinks spillage, and smoke, especially that associated with smoke machines.
- Handling:** To prevent damage to the controls and cosmetics avoid placing heavy objects on the control surface, scratching the surface with sharp objects, or rough handling and vibration. Protect the controls from damage during transit. Use adequate packing if you need to ship the unit.
- Servicing:** Switch off the equipment and unplug the power cord immediately if it is exposed to moisture, spilled liquid, objects fallen into the openings, the power cord or plug become damaged, during lightening storms, or if smoke, odour or noise is noticed. Refer servicing to qualified technical personnel only.
- Installation:** Install the console in accordance with the instructions printed in this User Guide. Do not connect the output of power amplifiers directly to the console. Use audio connectors and plugs only for their intended purpose.



Important Mains Plug Wiring Instructions

The console is supplied with a moulded mains plug fitted to the AC mains power lead. Follow the instructions below if the mains plug has to be replaced.

The wire which is coloured Green/Yellow or Green must be connected to the terminal in the plug which is marked with the letter E or with the Earth symbol.

This appliance must be earthed.

The wire which is coloured Blue or White must be connected to the terminal in the plug which is marked with the letter N.

The wire which is coloured Brown or Black must be connected to the terminal in the plug which is marked with the letter L.

Ensure that these colour codes are followed carefully in the event of the plug being changed.

Contents

Important Safety Instructions	3	Operating Instructions	12
Introduction	4	Replacing the Crossfader.....	14
Quick Start.....	5	Specification	18
Connectors and Panel Controls	6	Glossary	20
Installation	10	Order Codes	22
Cable diagrams	11	Tips and Troubleshooting	23

Introduction

Welcome to the **XONE:32** professional DJ mixer. This stylish and solidly built 3 channel club format console presents a unique combination of performance tools for the professional DJ. Above all, it features a sound quality second to none. **XONE:32** has been designed and constructed using the same rigorous standards we apply to our large format professional consoles used and respected by top engineers and performers throughout the world. We have had great fun designing this new range. We are sure you will get even more enjoyment using it.

We know you want to get started right away. For this reason we have kept this user guide concise and to the point. We recommend you read it through first. However, if even that is too much then at least read the QUICK START page before you plug up and go.

This user guide refers to the **XONE:32**. For further information on the basic principles of audio system engineering and mixing technique please refer to one of the specialist publications available from bookshops and audio equipment dealers. Whilst we believe the information in this guide to be reliable we do not assume responsibility for inaccuracies. We also reserve the right to make changes in the interest of further product development.

We are able to offer further product support through our world-wide network of approved dealers and service agents. You can also access our Web site on the Internet for information on our product range, assistance with your technical queries or simply to chat about matters audio. To help us provide the most efficient service please keep a record of your console serial number, and date and place of purchase to be quoted in any communication regarding this product.

Check out our home site www.allen-heath.com for information on the company and its pedigree, our full product range and our design philosophy. We also have a site dedicated to the exciting **XONE** console range www.xone.co.uk.

Key Features

- 3 Stereo channels with switchable line and RIAA phono inputs
- DJ microphone input
- Separate main mix, record, booth and headphones monitor outputs
- Stereo Aux output for effects
- 3 Band +6/-26 asymmetric EQ with extended cut
- Removable VCA CROSSFADER with reverse and variable contour
- Crossfade position dependent TRANSMUTE buttons for transform and punch effects
- Analogue state variable VCF filter effects with filter type, frequency and resonance controls
- LFO filter frequency control with finger tap tempo select
- DRSTM™ Digital Recall System with 4 user programmable presets for filter effects
- Advanced cue system with interlock and cue/mix fader for performance preview
- Extensive channel and output metering
- Sensible layout of setup and performance controls across three surfaces
- High grade dual rail gold contact crossfader
- Universal internal power supply for any worldwide mains voltage

- 1 Ensure your safety** Mains voltage is dangerous and can kill. First read and understand the Important Safety Instructions printed on page 3. Make sure that all equipment in your system is set for your local mains supply voltage and correctly grounded to ensure your safety. Do not turn anything on until you have checked your system wiring and control settings.
- 2 Set all controls to their starting position** Set all FADERS, GAIN, AUX, RESONANCE, HEADPHONES, BOOTH and MAIN MIX controls minimum (anti-clockwise). Set BAL, EQ and CONTOUR controls to their centre position. Set CROSSFADER to X (left), VCF slider to 20kHz (right) and CUE/MIX slider to cue (left). Set all switches to their up position.
- 3 Plug in your sources and outputs** Plug in two music sources, one to CH1 (X) the other CH3 (Y). Select the rear panel switches according to line or RIAA turntable source. Plug in your microphone if you are using one. We recommend you use a cardioid vocal dynamic type with built-in on/off switch. Plug the MIX OUT into the amplifiers feeding the main speakers, the BOOTH OUT into the amplifiers feeding the local DJ speakers, and plug in your stereo headphones. Good quality headphones of around 70 ohms impedance are recommended. It is very important that the amplifier level controls are turned right down at this stage.
- 4 Turn the system on** Switch on the mixer and music sources first. Check that the CH1 CUE, filter LPF and CROSSFADE ON indicators are on, the rest off. The LFO ON indicator should be flashing very slowly. Then switch on the amplifiers with their level controls turned down. The system should be quiet. If you hear any hum or buzz check the system for bad wiring, ground loops or missing grounds, in particular those connecting to turntables.
- 5 Adjust the level trims and cue the channels** Start the music playing and raise the LEVEL trim for each channel until its meter reads an average '0' with loud moments at '+5'. If the red 'PEAK' indicator flashes then back off the trim slightly. Slowly raise the headphones level control. You should hear CH1 CUE feeding the signal with the CUE/MIX fader set fully left for cue only. Press CH3 CUE to check the CH3 signal. If the music sounds distorted, bassy or thin check that you have plugged it into the correct Line or Phono inputs.
- 6 Route the music to the main speakers** With music playing and crossfader set to left hand X position, raise the CH1 fader to its top '0' position. Next, raise the MAIN MIX rotary master to maximum and check that the main meters display the music level. These should average '0' with loudest moments up to '+5'. If the red PEAK indicator flashes then back off the channel gain. Now slowly raise the amplifier level trim. You should start to hear the music through the main speakers. Set the amplifiers for the loudest volume you want to allow in the room with console meters reading as described above. If you are using a microphone then switch it on and raise its GAIN control until you hear it in the mix. Turn back the gain if the mic starts to feed back.
- 7 Route the music to the booth monitor speakers** Now set the BOOTH level rotary to maximum and slowly turn up the booth amplifier level trim until the monitor is as loud as you need it to be. Setting the levels in this way prevents the DJ exceeding the allowed maximum by setting all the console faders and masters to maximum. The meters provide an accurate display of the system capability. Access to the rear panel level trim controls can be restricted by covering them if needed.
- 8 Experiment with the level and crossfader controls** With two music sources playing (CH1=X, CH2=Y) you can experiment with these important performance controls. Adjust the crossfade CONTOUR from a gentle fade to very steep cut suitable for fast scratch mixing. You can reverse X and Y to suit your mixing style, and turn the crossfader off if it is not required. The TRANSMUTE button allows fast performance effects, transforming (muting) the signal if the crossfader is on its side, or punching the signal in if the crossfader is on the opposite side. Also experiment with the small CUE/MIX fader which lets you preview your mix in the headphones first.
- 9 Experiment with the EQ, VCF and LFO effects** Now the creative fun bit. With one channel playing, listen to the effect of cutting or boosting the three EQ controls. Press the channel FILTER switch to enable the VCF, experimenting with the FREQUENCY slider, RESONANCE and HPF/BPF/LPF type controls to change the sound. You can create subtle or dramatically sweeping effects. Watch the meters and pull back the fader if necessary to ensure you do not exceed the maximum volume allowed. Turn the LFO on and set its speed by tapping the TEMPO button. The VCF slider now becomes a depth control for LFO to modulate the VCF.
- 10 Store and recall the user presets** Once you have a VCF/LFO effect you like you can store this as a user preset to be instantly recalled during performance. Simply press and hold the required preset button for longer than 2 seconds to store the settings. Tap the button to recall a preset. The preset remembers the VCF and LFO settings as well as which channels are assigned to the filter.



Important Note about Hearing : To avoid damage to your hearing do not operate any sound system at excessively high volume. This also applies to any close-to-ear monitoring such as headphones. Continued exposure to high volume sound can cause frequency selective or wide range hearing loss. Make sure that your system complies with any venue sound level and noise regulations which may apply.

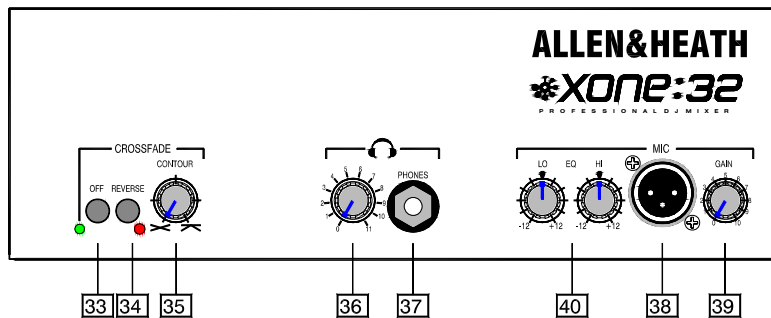
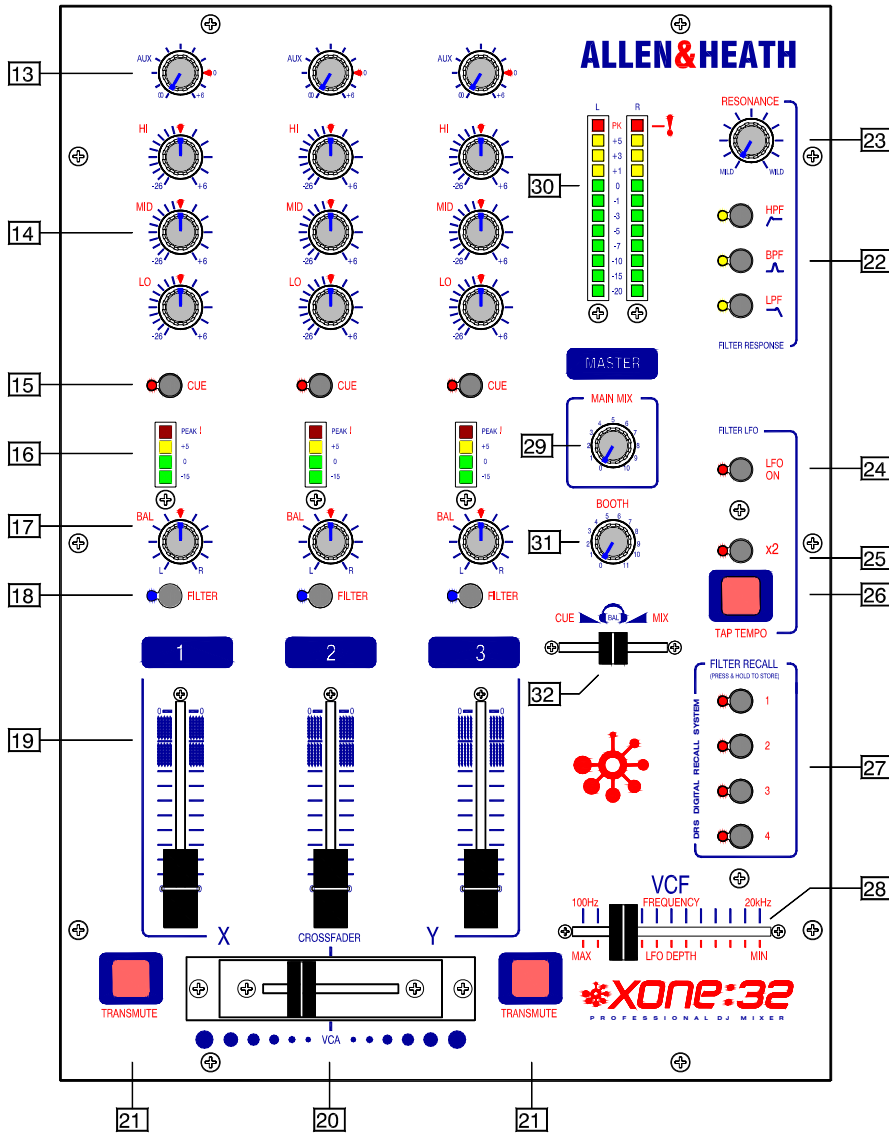
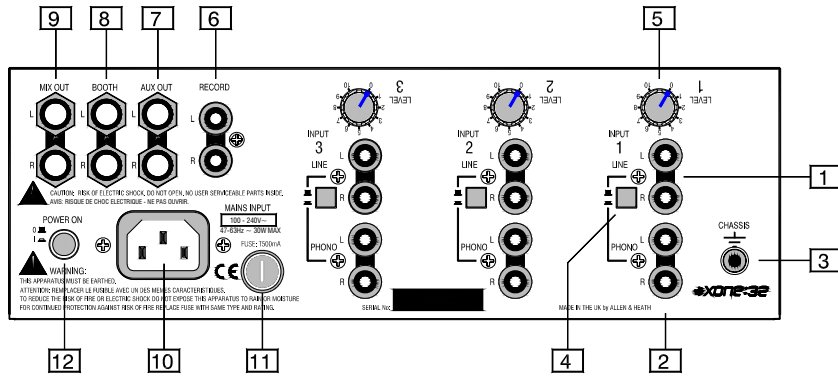

Connectors and Panel Controls

- 1 LINE input** 2x RCA phono. Connect stereo line level music sources such as CD, MD, DAT, drum machines, keyboards or other instruments. Do not connect turntables which require RIAA equalisation.
- 2 PHONO input** 2x RCA phono. Plug in turntables with magnetic cartridges requiring RIAA equalisation. For non-RIAA turntables plug into the LINE input instead. Do not plug in line level sources to the phono inputs as these will overload the preamp and cause severe high level distortion.
- 3 CHASSIS earth** A screw terminal is provided for connecting the earth straps from turntables. This connection earths the metal parts of the turntable to reduce hum, buzz or similar audible noise getting into the system. Make sure the terminal is fully tightened once the strap is in place.
- 4 INPUT SELECT switch** Selects either the LINE input or the PHONO input as the source to the channel. Press for PHONO, release for LINE. The select switches are positioned on the rear panel to prevent accidental operation during performance.
- 5 INPUT LEVEL trim** Rotary control to adjust the input gain to match the connected source to the console operating level. Adjusts from fully off to +15dB gain. Use the channel meter **16** to ensure the trim is correctly set for best performance. The trims are positioned on the rear panel so that they are protected from accidental operation once set.
- 6 RECORD output** 2x RCA phono. This provides a line level stereo mix output not affected by the main mix master control. Connect to a stereo recorder such as MD, DAT or cassette to record the DJ's set.
- 7 AUX output** 2x TRS jack. Provides a line level stereo output independently mixed from the channel AUX sends **13**. You can use this to feed samplers and other effects units, an additional monitor, zone or recorder. The output is impedance balanced so it can connect to balanced or unbalanced equipment.
- 8 BOOTH output** 2x TRS jack. This is the stereo output that feeds the DJ's local booth monitor system. It has its own level control and is not affected by the main mix master control or the cue mix. The output is impedance balanced so it can connect to balanced or unbalanced equipment.
- 9 MIX output** 2x TRS jack. This is the main stereo output that feeds the house PA. The output is electronically balanced so it can drive long cable runs to balanced equipment without interference pickup. It can also be wired to connect to unbalanced equipment.
-  **10 MAINS input** IEC socket. Plug the AC mains supply in here. A country dependent mains lead with moulded plug is provided with the console. **Ensure the local mains voltage is within the range specified on the panel and that the connection is correctly grounded.**
- 11 FUSE** This is the mains input protection fuse for the internal power supply. In the unlikely event of it failing make sure you replace it with the same type and rating. If the replacement fails get the console checked by your service agent.
- 12 POWER ON switch** Turns the console on or off. To avoid loud thumps or damage to your speakers always turn amplifiers off before turning the console or other equipment in the signal chain on or off. Turn amplifiers on last and off first.
- 13 AUX SEND control** Adjusts the level of the channel signal to the stereo Aux output. It is taken 'post-fade' which means that the channel fader affects the level sent to the aux control. Turn fully anticlockwise to turn the signal off, fully clockwise for a maximum +6dB boost. The normal '0' position is marked.
- 14 Channel EQ** The equaliser has three controls to let the DJ creatively alter and shape the sound during live performance. The music frequency spectrum is divided into 3 bands. **HI** (10kHz) has a shelving response and affects the high frequency (treble) sounds, **MID** (1kHz) has a peak/dip bell shaped response and affects mid range (presence) sounds, and **LO** (100Hz) has a peak/dip bell shaped response and affects low (bass) sounds. This type of equaliser is known as 'asymmetric' because the amount of boost and cut is not the same. Boost is restricted to a safe +6dB to highlight selected sounds while preventing system overload through heavy use. Cut on the other hand, is increased to a huge -26dB to completely suck out affected frequencies dramatically changing the effect. Use cut rather than boost to create your dramatic performance effects.
- 15 CUE switch** Press this momentary switch to listen to the channel signal in the headphones. The three switches are interlocked so that pressing one or more cancels the previous. The LED illuminates so that you can see at a glance which channel is cued. A cue selection is always active. Switch on default is CH1 cue selected. You can preview the mix using the CUE/MIX slider **32**. Cue does not affect the house mix or booth speakers and lets you check the signal or cue a track before bringing it into the mix. Cue is pre-fader and post-EQ so that you can preview and experiment with the EQ effects before going live.
- 16 Channel METER** A 4 LED meter bar always shows the presence of the pre-fader channel signal. Adjust the level trim control for normal music averaging 0dB with loudest moments reaching +5. Reduce the trim if the red PEAK LED flashes consistently. The PEAK LED lights at +8dB to warn that you are within 12dB of clipping. Letting the signal clip will result in a harsh distorted sound that can damage the speakers and is very unpleasant for the listener. A good DJ will not let this happen.

17 BALANCE control Adjusts the balance between the channel left and right stereo signals. Each side ranges from fully off to fully on. The control has unity gain in the centre equal position and +2dB boost when fully panned to one side. It is typically used for performance effect.

18 FILTER ON switch Press this momentary switch to route the channel through the filter stage for amazing analogue VCF (voltage controlled filter) effects. The blue LED lights when the VCF is enabled for the channel. The state of the switch is stored and recalled by the DRS™ presets.

19 Channel FADER A high grade 60mm stereo fader adjusts the channel signal level from off to the normal '0' top position. It allows smooth fade ins and quick action live performance level effects. CH1 fader routes the signal to the X side of the crossfader. CH3 routes the signal to the Y side of the crossfader. CH2 does not route through the crossfader. The fader also affects the AUX sends **13**.

20 CROSSFADER The crossfader lets you smoothly fade from one track into another using a single fader. It is also used as a creative performance tool to layer or interact between two sounds when cut or scratch mixing. It can be easily replaced if it becomes damaged or worn through exceptional mechanical operation. Long life is assured as the **XONE:32** uses a high quality dual rail gold contact crossfade type together with VCA circuitry which means that no audio is passed through the fader itself. CH1 routes to X, CH3 routes to Y, CH2 does not route through the crossfader. The response of the crossfader can be adjusted to match your mixing style using the CONTOUR and REVERSE controls **35**.

21 TRANSMUTE buttons The **XONE:32** introduces this unique function which combines the familiar 'transform' and 'punch' DJ effects with an intelligence that opens up a new world of creative live performance effects. The function of the button depends on the position of the crossfader. TRANSMUTE becomes a transform button when the crossfade has moved away from the opposite side. It acts as a momentary action mute that turns the signal off while the button is held. TRANSMUTE becomes a punch button when the crossfader is right at the opposite side playing the other track. Here it punches the signal in (turns it on) on top of the other track. For example, the CH1 track may be playing... Pressing X TRANSMUTE transforms (mutes) that track, and pressing Y TRANSMUTE punches the CH3 track over the CH1 track.

22 VCF Filter Type Select Press one or any combination of the three momentary press buttons to select the VCF response type. Default on power up is LPF (low pass filter) which cuts off all frequencies above the selected frequency. Alternatively, you can select BPF (band pass filter) to cut off frequencies above and below, or HPF (high pass filter) to cut off frequencies below, or press two or three buttons together to create different effects. One or more types is always selected. The associated LED indicator is illuminated. The selected type is stored and recalled by the DRS™ presets.

23 RESONANCE control Adjust this to change the 'Q' or 'sharpness' of the filters. This affects how they respond around the cut-off frequency. At the minimum MILD setting the filters have a gentle roll-off 'knee' giving a subtle, smooth response. At the clockwise WILD setting they produce a resonant feedback boost around cut-off resulting in some very dramatic performance effects. The sound varies according to the filter type selected. To avoid unexpected results it is best to start experimenting with RESONANCE set to a low (mild) position.

24 LFO ON switch Press this momentary switch to let the LFO (low frequency oscillator) take over control of the VCF by modulating its cut-off frequency. The LED indicator always flashes green to display the currently set speed. It turns red when the LFO is switched in and continues to flash green to indicate speed. The VCF FREQUENCY slider **28** changes function to become a depth control to determine how much modulation is applied. The state of this switch is stored and recalled by the DRS™ presets.

25 x2 switch Doubles the speed of the LFO as set by tapping in the tempo. This lets you tap in the beat of the track and create a double modulation per beat. The state of this switch is stored and recalled by the DRS™ presets.

26 TAP TEMPO button Tap this button with your finger to set the speed of the LFO. It automatically follows your beat after two or three taps. You can double the speed by pressing the x2 switch **25**.

27 FILTER RECALL (DRS™ presets) This feature unique to Allen & Heath provides 4 preset buttons which lets you store and recall your favourite VCF performance settings. This lets you punch in sophisticated filter effects changes. When you first turn the console on there are no presets stored or recalled. Press and hold one of the preset buttons for longer than 2 seconds to store the current settings into that memory. Tap the button during performance to instantly recall that preset. The presets do not store the VCF resonance, frequency, LFO depth or speed. The parameters stored include:

- CH1-3 FILTER ON switch – Which channels have the VCF enabled
- VCF type – Which combination of HPF, BPF and LPF is active
- LFO ON switch – Whether the VCF is manually controlled or modulated by the LFO
- LFO x2 switch – Whether the LFO speed is 1x or 2x the current speed

28 VCF control slider This is a performance control 'played' by the DJ to create live effects in a similar way to using the crossfader. Its function depends on whether the LFO is switched on or off. If the LFO is off then the slider lets you manually set the cut-off frequency of the filter from a very low 100Hz to ultra high 20kHz. If the LFO is switched on then the slider becomes a depth control for the LFO letting you adjust how much the LFO modulates the filter cut-off frequency. Depth is off when the slider is fully right. Maximum effect is fully left as the DJ pulls the slider in towards the other performance controls.

29 MAIN MIX MASTER control A rotary master control adjusts the output level feeding the house PA. This is a stereo control which adjusts the left and right signals at the same time. It affects the stereo MIX output. Note that it does not affect the record and booth outputs. The maximum position represents unity (0dB) gain. If you find yourself normally setting the control in the lower part of its travel then the connected equipment may be too sensitive for the operating level of the console. With the control set to its maximum position adjust the input level trim of connected equipment for the loudest level allowed. **In a club or similar installation strict sound level and noise regulations may apply. Check that your system levels are set up to comply.**



30 MAIN METERS A pair of LED meter bars displays the level of the MAIN MIX output. Each meter has 12 LEDs to indicate signal levels from a low -20dB. Green and yellow LEDs indicate normal operating levels. The top red PEAK led lights at +8dB giving you plenty of warning that you are within 12dB of clipping. Meter '0' represents +4dBu at the XLR outputs. The meters are peak responding with a fast attack and are therefore able to display fast transients accurately. The top five LEDs are 'peak hold' which means that the highest remains lit for a short time after the signal has gone. This makes it easier to keep track of the highest levels and transient peaks. **Do not operate the console with these meters lighting red more than the occasional flash. Failure to observe this can result in severe signal distortion which may damage equipment.**



31 BOOTH MASTER control Adjusts the level of the signal to the stereo booth monitor output. This does not affect the level in the headphones.

32 CUE/MIX slider This affects what you hear in the headphones. When fully left, only the CUE signal is routed. The CH1, 2 and 3 CUE switches are interlocked with a selection always active. When fully right, the main MIX is routed so you hear only what is being sent to the house speakers. Move the slider between these positions to mix the active CUE signal with the MIX. This not only lets you use the headphones to cue tracks ready to bring them into the mix, but also accurately adjust point and tempo against the currently playing track and preview how the mix will sound. You use this slider as a 'crossfader' to test the mix in your headphones only. It does not affect the booth or house mix.

33 CROSSFADE OFF switch This front panel switch lets you disable the crossfader so that the channels route directly to the main mix. The green LED lights when the crossfader is enabled.

34 CROSSFADE REVERSE switch Reverses the X and Y sides of the crossfader so that CH1 feeds Y and CH3 feeds X. This better suits the mixing style of some DJ's.

35 CROSSFADE CONTOUR control This adjusts the law of the crossfader from a gentle fade with 6dB dip at centre position to a very sharp fade where full level is achieved just a few millimetres from the end stop. The control can be adjusted to suit the DJ's preference or mixing style.

36 HEADPHONES LEVEL control Adjusts the level of the signal in the stereo headphones. This does not affect the level of the booth monitor. **WARNING: Some headphones are more sensitive than others and can produce higher output levels. To avoid damage to your hearing start with the level control at minimum and turn up only as much as is needed to maintain comfortable listening level. Do not drive headphones at high listening levels for long periods of time.**



37 PHONES socket This output is positioned on the front panel so that the DJ can plug favourite headphones in without needing access to the rear. Headphones are available in many different styles, impedances and volume ratings. To get the best from your system we recommend that you use high quality closed-ear headphones around 70 ohms impedance, although 30 to 600 ohms will work. 8 Ohm headphones are not recommended. Avoid using mini-jack to 1/4" jack adapters as these may quickly prove unreliable.

38 MIC input Balanced XLR. Plug your DJ microphone in here if you choose to use one. It is best to use a mic with integral on/off switch so that the DJ can turn it off when it is not being used. Use rugged, good quality low impedance dynamic microphones such as those specifically designed for vocals. Do not use high impedance or unbalanced microphones, or condenser types which require phantom power.

39 MIC GAIN control Adjusts the level of the microphone signal in the main mix from fully off to +45dB gain. Start with the control set fully off (anticlockwise).

40 MIC EQ controls A 2 band EQ with shelving HI and LO controls provide +/-12dB of adjustment of the low and high frequencies to suit the DJ's microphone style. LO is set at 300Hz to help cut boominess or enhance warmth, while HI is set at 5kHz to cut harshness or boost clarity and intelligibility over the mix. Avoid extreme settings. Note that there is a built-in high pass filter which cuts very low frequency sounds such as popping and mic handling noise.

Installation

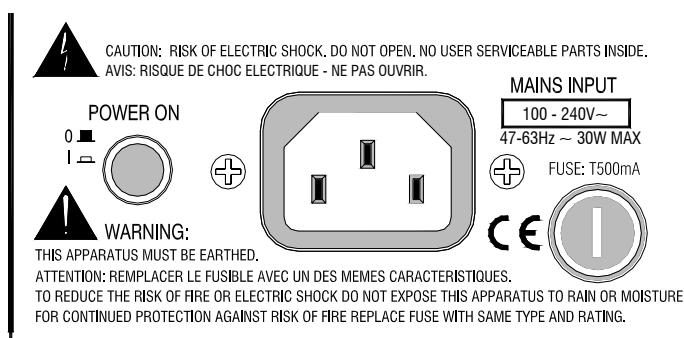

Connecting Mains Power Read the SAFETY INSTRUCTIONS printed at the front of this User Guide and on the rear panel. Check that the correct mains lead with moulded plug has been supplied with your console. The power supply accepts 50/60Hz AC mains voltages within the range 100-240V without changing any fuses or settings.

It is standard practice to turn connected power amplifiers down or off before switching the console on or off. This prevents any audible switch-on thumps. Ensure that the IEC mains plug is pressed fully into the rear panel socket before switching on.

Earthing

The connection to earth (ground) in an audio system is important for two reasons:

1. **SAFETY** - To protect the operator from high voltage electric shock, and
2. **AUDIO PERFORMANCE** - To minimise the effect of earth (ground) loops which result in audible hum and buzz, and to shield the audio signals from interference.

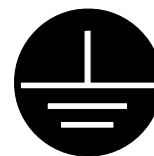

For safety it is important that all equipment earths are connected to mains earth so that exposed metal parts are prevented from carrying high voltage which can injure or even kill the operator. It is recommended that the system engineer check the continuity of the safety earth from all points in the system including microphone bodies, turntable chassis, equipment cases, and so on.

The same earth is also used to shield audio cables from external interference such as the hum fields associated with power transformers, lighting dimmer buzz, and computer radiation. Problems arise when the signal sees more than one path to mains earth. An 'earth loop' (ground loop) results causing current to flow between the different earth paths. This condition is usually detected as a mains frequency audible hum or buzz.

To ensure safe and trouble-free operation we recommend the following:

- **Have your mains system checked by a qualified electrician** If the supply earthing is solid to start with you are less likely to experience problems.
- **Do not remove the earth connection from the console mains plug** The console chassis is connected to mains earth through the power cable to ensure your safety. Audio 0V is connected to the console chassis internally. If problems are encountered with earth loops operate the audio 'ground lift' switches on connected equipment accordingly, or disconnect the cable screens at one end, usually at the destination.
- **Make sure that turntables are correctly earthed** A chassis earth terminal is provided on the console rear panel to connect to turntable earth straps.
- **Deal with ground loops** Should you experience hum or buzz caused by ground loops, check first that each piece of equipment has its own separate path to ground. If so, operate ground lift switches on connected equipment in accordance with the instruction manuals. Alternatively disconnect the cable screen at the destination end only. This breaks the offending loop while still maintaining the signal shielding down the length of the cable.
- **Use low impedance sources** such as microphones and line level equipment rated at 200 ohms or less to reduce susceptibility to interference. The console outputs are designed to operate at very low impedance to minimise interference problems.
- **Use balanced connections for the microphone and main outputs** as these provide further immunity by cancelling out interference that may be picked up on long cable runs. Refer to the cable drawing for information on how to connect balanced and unbalanced equipment.
- **Route cables to avoid interference** To avoid interference pickup keep audio cables away from mains power units and cables, thyristor dimmer units or computer equipment. Where this cannot be avoided, cross the cables at right angles to minimise interference.
- **Use good quality cables and connectors** and check for correct wiring and reliable solder joints. Allow sufficient cable loop to prevent damage through stretching.
- **If you are not sure ...** Contact your service agent or local Allen & Heath dealer for advice.

Cables and Connections

The **XONE:32** uses professional grade 3 pin XLR, 1/4" TRS jack and RCA PHONO sockets. The following mating plugs may be used:

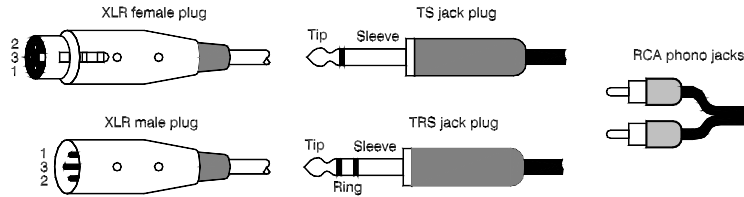

The microphone input **XLR** connector is 3 wire balanced. This has 3 connector pins: Pin 1 = ground (screen), Pin 2 = signal hot (+), Pin 3 = signal cold (-). The jack sockets are the 3 pole **TRS** type. These are wired to work with either the balanced TRS or the unbalanced 2 pole TS type plugs without cable modification. The sockets have 3 connector pins: Inputs and outputs are Tip = signal hot (+), Ring = signal cold (-), Sleeve = ground (screen). Headphones are Tip = left, Ring = right, Sleeve = ground. The **RCA** phono connectors are 2 wire unbalanced to connect to equipment such as CD players, turntables and domestic amplifiers.

To ensure best performance, we recommend that you use high quality audio cables and connectors, and take time to check for reliable and accurate cable assembly. It is well known that many audio system failures are due to faulty interconnecting leads. Avoid reversing + and - on balanced connections as this will result in reverse polarity connections which may cause signal cancellation effects. Refer to the cable diagram for how to wire unbalanced to balanced connections. **It is fine to use a Y-adapter to feed one output to several inputs, but never use a Y-adapter to sum two outputs into one input.**

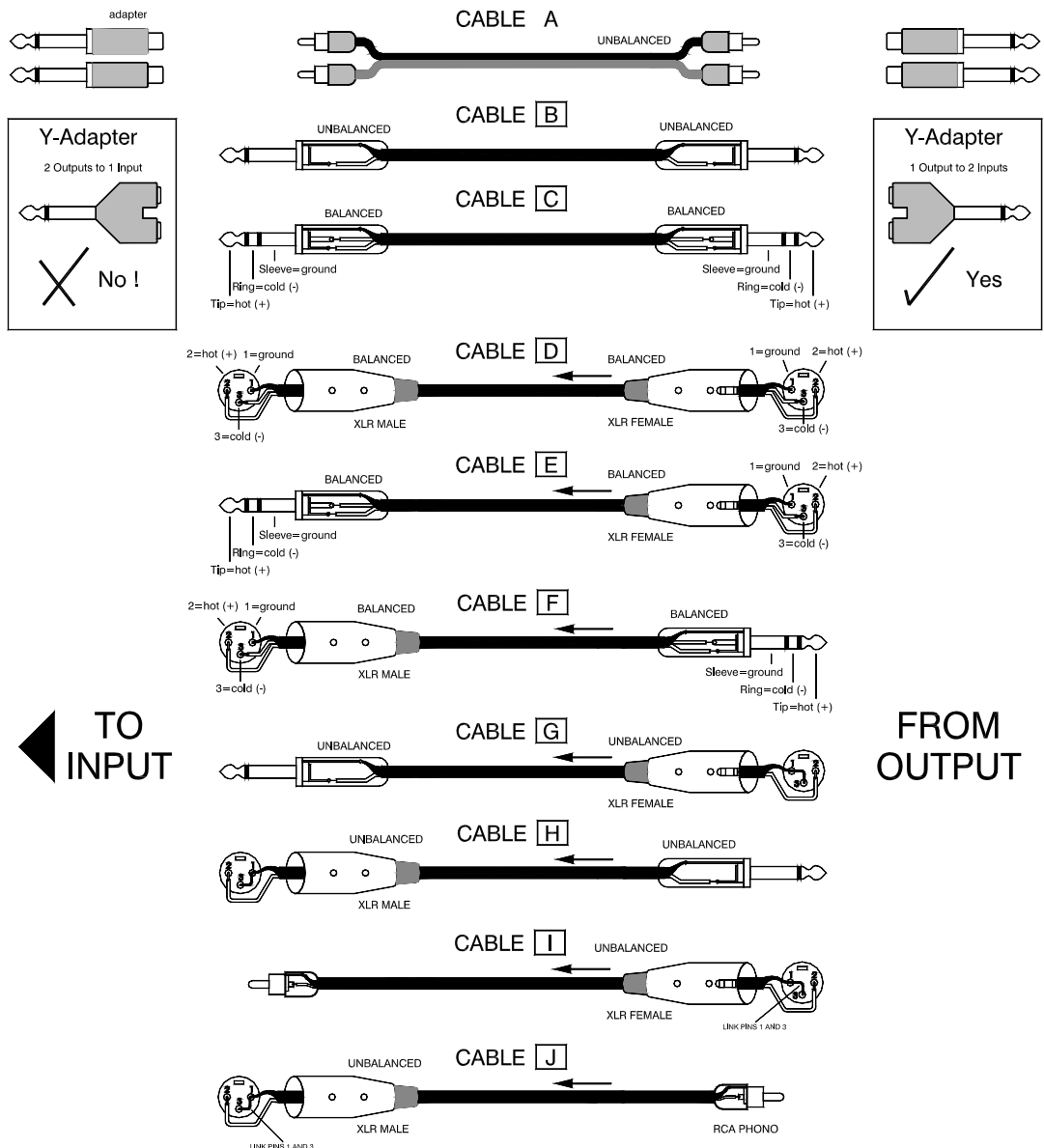

Operating Instructions

The QUICK START page near the beginning of this user guide gives you a quick introduction to using the **XONE:32** if you want to get going right away. You can achieve much simply by experimenting and trying out different combinations of settings. The notes here provide further information to get the most out of your console. It is not intended as a guide to how to mix or structure your performance. That is your art...

Overview of the Application

This diagram shows an example hook-up to demonstrate how the **XONE:32** can be connected in a typical DJ application. Note that you do not need to connect the channels in the order shown, also that the connector types on the equipment you connect to may be different to that shown. Use cables appropriate to your application. Please read the INSTALLATION section before connecting to your equipment. The following describes how the console is used in this example application:

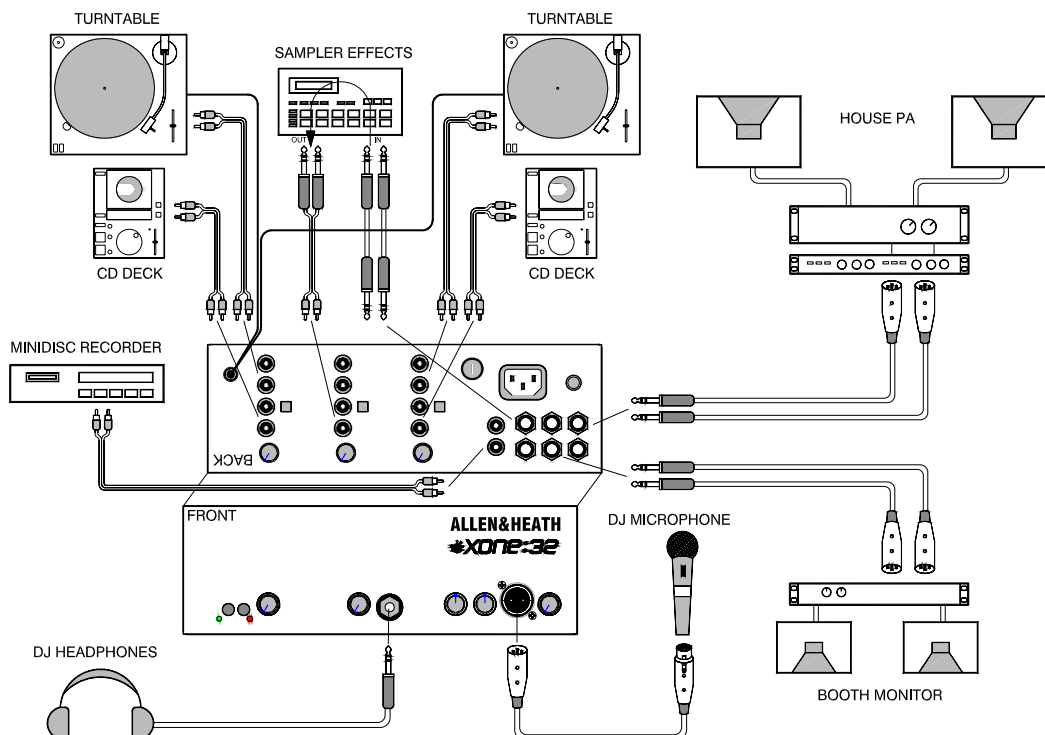

DJ Microphone and Headphones: The DJ plugs the preferred headphones and microphone (if required) into the front of the console. It is not uncommon for several DJ's to perform their sets during a session plugging in their own mic and headphones each time. The console cue system works with the headphones to let the DJ cue tracks and preview the mix before going live.

Mix music sources: CH1 and CH3 are used for the mix music sources. Both a turntable and a CD deck are plugged into each, one for each side of the crossfader. The turntable magnetic cartridges plug into the RIAA equipped phono inputs, the CD into the line inputs. The required source is preselected using the rear panel select switch. This gives the DJ the choice of vinyl or CD mixing. Alternatively, the DJ could plug other sources such as a drum machine into the line input.

Sampler effects: The stereo Aux send is used to feed selected channels to an external effects unit such as a sampler or echo device. The sampler output is returned into CH2 line input and becomes another creative source that can be added to the mix using the channel fader.

Mix output: This stereo output feeds the house PA system to provide quality sound to the dance floor. The connections are balanced to feed long cable runs to the amplifier system. They may plug into system processors such as protection limiters, EQ and crossovers which in turn connect to the amplifiers.

Recording the show: This dedicated stereo output connects to a recorder such as the MiniDisc shown to record the DJ's set. The recording is not affected by the master mix control.

Booth monitor: A stereo speaker system provides the DJ with a local monitor. This has its own level control so it can be adjusted to suit without affecting the house sound.

Gain and Operating Levels

It is most important that the system gain and level settings are correctly set. It is well known that many DJs push the gain to maximum with meters peaking hard in the belief that they are getting the best from the system. **THIS IS NOT THE CASE !** The best can only be achieved if the system levels are set within the normal operating range and not allowed to peak. Peaking simply results in signal distortion, not more volume. It is the specification of the amplifier / speaker system that sets the maximum volume that can be achieved, not the console. The human ear too can fool the operator into believing that more volume is needed. Be careful as this is in fact a warning that hearing damage will result if high listening levels are maintained. Remember that it is the **QUALITY** of the sound that pleases the ear, not the **VOLUME**.

Use the **LEVEL TRIM** to match the input source to the normal operating level of the console. Adjust this so that the **CHANNEL METER** averages 0dB with loudest moments reading +5. Press the **CUE SWITCH** to listen to the signal on headphones. Adjust the **CHANNEL FADER** and **MASTER LEVEL** so that they normally operate in the near the top of travel. Make sure the amplifier/speaker system has been correctly calibrated for the loudest volume required at the fader top position. Boosting the EQ also adds gain to the system. Reduce by turning back the **LEVEL TRIM** if the meter red peak LEDs flash. Adjust the **HEADPHONES** and **BOOTH** monitor controls for safe listening levels.

The diagram illustrates the operating range of the audio signal.

NORMAL OPERATING RANGE. For normal music the signal should range between -5 and +5 on the meters with average around 0dB. This allows enough **HEADROOM** for unexpected peaks before the signal hits its maximum **CLIPPING** voltage and distorts. It also achieves the best **SIGNAL-TO-NOISE-RATIO** by keeping the signal well above the residual **NOISE FLOOR** (system hiss). The **DYNAMIC RANGE** is the maximum signal swing available between the residual noise floor and clipping.

The **XONE:32** provides a massive 108dB dynamic range.

A final note ... The human ear is a remarkable organ with the ability to compress or 'shut down' when sound levels become too high. Do not interpret this natural response as a reason to turn the system volume up further ! As the session wears on ear fatigue may set in, and the speaker cones may become hot so reducing the effectiveness of the system and listeners to gain any benefit from increased volume.

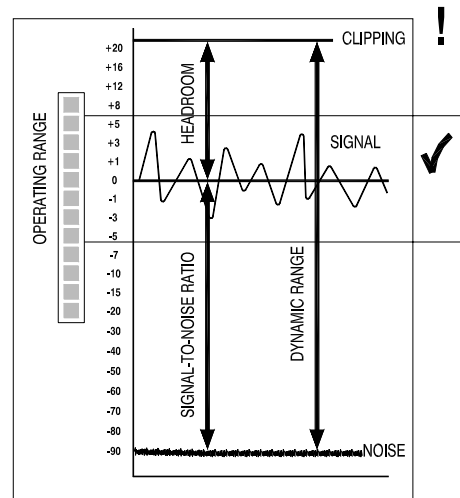

BE SENSIBLE, BE SAFE WITH SOUND LEVELS



Using the Channel EQ

With the 3 EQ controls set to their centre detented position the EQ has no affect on the sound. The asymmetric EQ design provides a huge amount of cut to suck out selected frequencies for dramatic effect, and a restricted amount of boost to enhance frequencies without overloading the system. Turn the controls clockwise to boost the selected band of frequencies by up to 6dB. Turn them anticlockwise to cut the frequencies by up to 26dB.

Cutting low, mid or high frequency bands can be very effective when layering one track on another. This lets you enhance the sounds you want while cutting those you don't want. For example, you could fade in the high frequency cymbal line of the CH3 track on top of the currently playing CH1 track by cutting the MID and LO EQ on CH3. Learn what the EQ can do by playing a selection of tracks and experimenting with the controls.

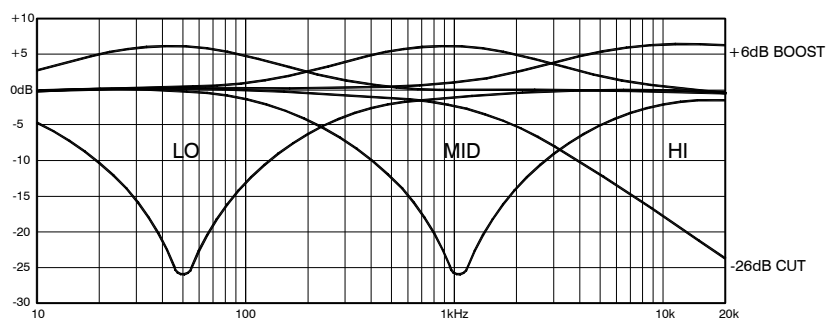

Using the Crossfader

The crossfader is the one feature that instantly sets the DJ mixer apart from a conventional mixer. It lets you smoothly fade from one track into another using a single fader. It is also used as a creative performance tool to layer or interact between two sounds when cut or scratch mixing. A high grade dual rail fader with long lasting gold contacts is used. The ultra high quality Penny & Giles type can be fitted as an option if preferred.

The **XONE:32** uses four high performance voltage controlled amplifiers (VCAs), a pair for each side of the stereo crossfader. The robust 45mm fader produces a DC control voltage which determines the signal level of the VCAs. The voltage is filtered to prevent any audible noise, clicks or scratchiness resulting should the fader track become worn. This benefit would not be possible if the signal were routed through a conventional audio fader. Using the fader as a controller also means that its response can be easily tailored to suit the mixing style.

CH1 feeds the left 'X' side of the crossfader so that all the signal is routed when the fader is at its fully left position. CH3 feeds the right 'Y' side of the crossfader. CH2 does not feed the crossfader. Instead, it routes directly to the mix. The **OFF** switch lets you disable the crossfader so that it does not affect the channel levels. Select this when your mixing session does not need crossfading. The front panel green LED lights when the crossfader is on and extinguishes when it is off.

Use the **CONTOUR** control to adjust the way the fader responds as you move it. You can adjust from a very gentle fade with 6dB dip in the middle suitable for smoothly fading in one track as the other fades out, to a very sharp response where the signal reaches full level within a few millimetres of the start of travel, suitable for fast cut or scratch mixing. The middle position provides a standard constant power fade where the volume remains the same as you fade from one track to the other.

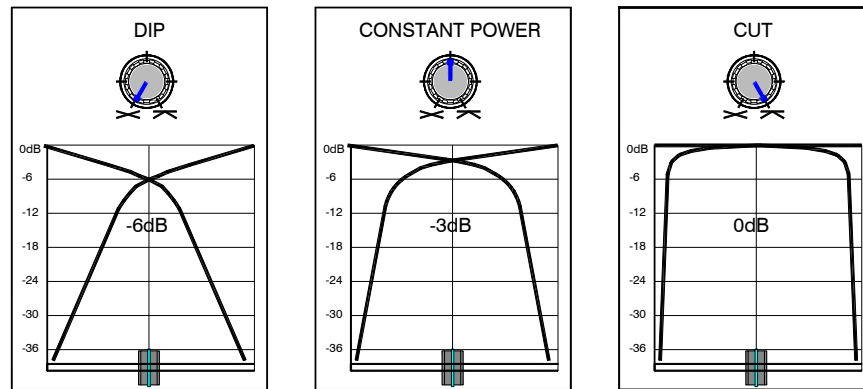

Use the **REVERSE** switch to swap the X and Y sides of the crossfader so that CH1 feeds the right hand Y side and CH3 feeds the left hand X side. Use this function if it better suits your mixing style.

Replacing the Crossfader

The crossfader on a DJ mixer is heavily used and can suffer considerable wear and tear. The audio design using VCAs prevents clicks and scratchiness as the fader wears. However, the movement can become mechanically stiff or sloppy in time, or become ingrained with dirt. Should this be the case the fader may need replacement. The **XONE:32** crossfader is removable and can easily be replaced in a few minutes. There are two versions available, the standard type and the higher grade Penny & Giles type. Make sure you order the correct version from your Allen & Heath dealer.

Use a medium size cross-point (Pozidriv) screwdriver to undo and remove the two outer screws on the crossfader plate. Do not remove the inner screws. Lift the crossfader assembly up and away from the console panel. Unplug the cable from the old crossfader and plug in the new assembly. Check that the connector is correctly aligned and pushed on. Replace the assembly making sure the cable faces the left side of the console. Refit the screws and test operation.

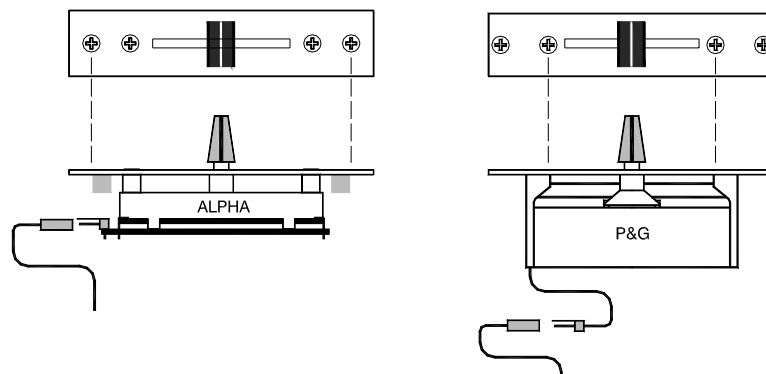

The TRANSMUTE Buttons

The unique Allen & Heath TRANSMUTE function combines the popular TRANSFORM and PUNCH effects into one 'intelligent' quick action performance button per side of crossfader.

What it does is determined by the position of the crossfader. With the fader at any position away from the opposite side to the button it provides the TRANSFORM function, muting (turning off) the music. With the fader fully at the opposite side it becomes a PUNCH button switching in the music to layer it on top of the other channel which is playing. This gives you both effects at the same time.

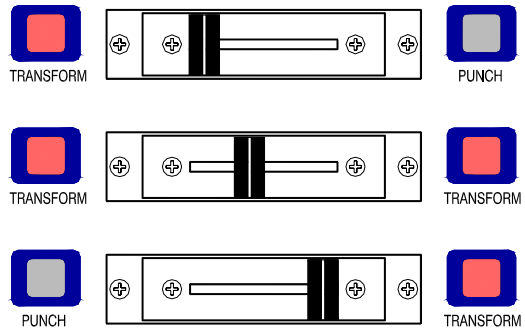

Using the VCF

A Voltage Controlled Filter is an audio filter whose cut-off frequency is altered by a DC control voltage rather than a variable resistor. This produces a much wider operating range and more control over the filter response to create unlimited combinations of tonal effect. The **XONE:32** filter is 'state variable'. This means that it provides three simultaneous filter types, high-pass, band-pass and low-pass. The analogue circuit with its resonant feedback path produces the classic warm filter sound often associated with analogue synthesisers.

Each channel can be switched in or out of the filter path using its **FILTER** switch. Use this to punch the filter effect in or out. The blue LED lights when the channel is routed through the filter.

Adjust the **RESONANCE** control to change the 'Q' or 'sharpness' of the filters. This affects how they respond around the cut-off frequency. At the minimum MILD setting the filters have a gentle roll-off 'knee' giving a subtle, smooth response. At the clockwise WILD setting they produce a resonant feedback boost around cut-off resulting in some very dramatic performance effects. The sound varies according to the filter type selected. To avoid unexpected results it is best to start experimenting with RESONANCE set to a low (mild) position.

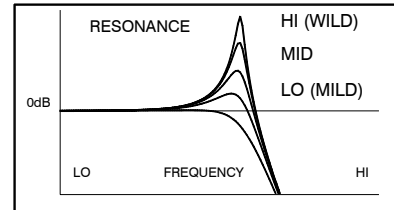

High RESONANCE settings can result in significant boost of selected frequencies. Reduce the channel level if the signal levels increase enough to light the red PK LEDs in the output meters. Failure to do this may result in system overload and distortion.

The **VCF FREQUENCY** can be adjusted in two ways, either manually using the VCF slider control, or automatically by modulating it with the LFO. This parameter is controlled during performance to create the dramatic effects possible only with a filter of this type.

VCF slider frequency sweep

When the LFO is switched off the VCF slider becomes a manual control of the cut-off frequency. It sweeps the frequency from a very low 100Hz to ultra high 20kHz. The slider provides a light, smooth action and is used in a similar way to the crossfader to creatively enhance the musical performance. The effect depends on the filter type selected.

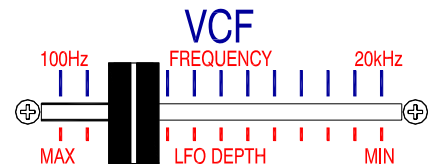

LFO frequency modulation

When the LFO is switched on it takes control of the VCF cut-off frequency. The **LFO ON** switch LED lights red when it is on. The VCF slider is no longer a manual sweep control but instead becomes the depth control to determine how much the LFO affects the filter. It ranges from no effect at the fully right position to maximum effect when fully left. The frequency is modulated by the LFO at the speed set using the **TAP TEMPO** button. Simply tap the button at the tempo you want and the LFO will follow and lock on to this speed. The speed is always shown by the LFO ON LED flashing green, even when it is switched off. Pressing the **x2** switch doubles the speed dramatically changing the way the filter affects the music with the beat.

We recommend that you experiment with the filter controls to fully explore the possibilities before you use the effects live. Combined with the **DRS™** user presets you have a powerful tool for complex yet instant performance creativity.

Filter Type

Select the **FILTER TYPE** you want to use. Three switches with LEDs select which type is active. You can press any combination together to create different response types such as 'notch' and an interesting 'all-pass' effect. The switches are 'soft switched' for live performance, meaning that the audio signal is ramped between filter states to prevent audible clicks. The selected type affects both X and Y filters.

Note that the last selected type is lost when power is removed from the console. The LPF is always selected when power is applied. However, you can store the current selection in the **DRS™** user presets for instant performance recall.

The graphs here show the effect on the audio frequency response for the three filter types. The range of sweep from low to high frequency is shown together with the effect of adjusting **RESONANCE** (one frequency with several resonance settings shown).

The vertical scale shows the amount of cut or boost around the normal 0dB operating level. The horizontal scale shows the change in frequency from low (bass) to high (treble).

HPF. Press this switch to select the high-pass filter. Frequencies below the cut-off point are removed. The cut-off point is adjusted using the VCF slider control or modulated using the LFO. At low end little effect is heard as only sub bass frequencies are removed. Sweep higher to gradually remove the bass line followed by the higher frequencies. The highest frequency is limited to 10kHz as little useful material is heard beyond this. **TIP** - Try switching the HPF in with VCF set at highest frequency, then gradually sweeping the frequency back to minimum. This can create an atmosphere of anticipation as the dance floor awaits the power of the beat to kick in.

BPF. Press this switch to select the band-pass filter. Frequencies above and below the cut-off point are removed leaving just a narrow band of sound. Sweep the VCF slider around its mid position to affect lead sounds such as keyboard and vocals. **TIP** - Try picking out individual sounds such as vocals and mixing them into the beat and bass of the opposite track to create a whole new mix. Add a little resonance to the BPF to lift the sound out of the mix.

LPF. Press this switch to select the low-pass filter. Frequencies above the cut-off point are removed. The cut-off point is adjusted using the VCF slider control or modulated with the LFO. At minimum only sub bass remains. Sweep higher to gradually introduce the bass line followed by higher frequencies into the mix. **TIP** - Try sweeping the LPF back to a low setting to keep the beat and energy going while talking over the mix. Try also punching in the filter and sweeping it back from high to low in time with the beat. Punch it out at the start of the next bar.

In addition to the three basic filter types you can experiment with new effects by selecting combinations of switches together. Press and release the switches together. They illuminate to show which filter types are active. For example:

HPF+LPF = NOTCH. Used with low settings of **RESONANCE** you get a phasing effect. Try sweeping the effect across the frequency range.

HPF+BPF+LPF = ALL PASS. A surprising effect considering that all frequencies are 'passed'. However, the filter type interaction around the cut-off point creates an interesting effect that varies from subtle to dramatic depending on the **RESONANCE** setting.

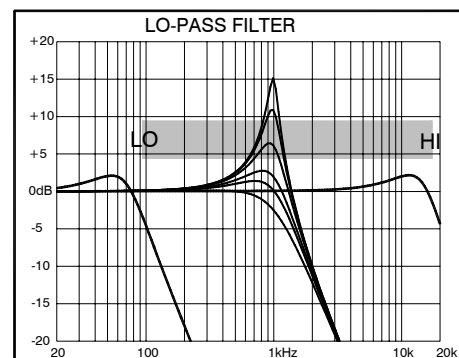
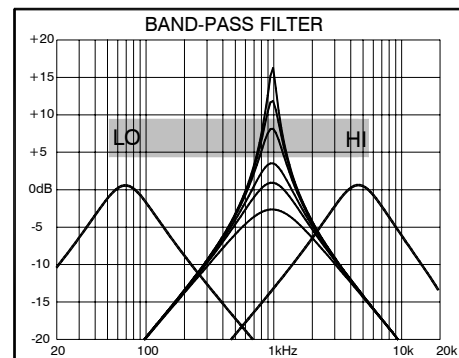
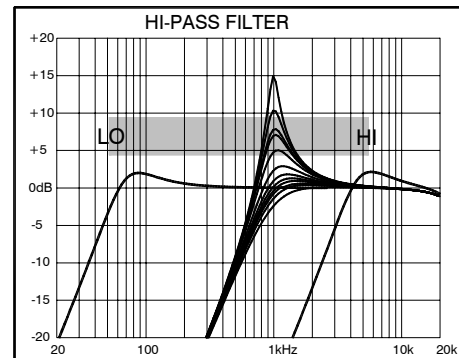

Using the DRS™ User Presets

The Digital Recall System is a powerful performance function pioneered by Allen & Heath. It uses on-board memories to store and recall the filter settings. You can store four different combinations of the VCF switch settings in the four user programmable memories. Once stored they can be instantly recalled by pressing the preset button. The presets become performance controls letting you make dramatic changes to the configuration of the filter instantly and very easily.

When you power up the console none of the presets is selected and all their LED indicators are off. The console always powers up with its default settings. The user presets are retained when power is removed. Pressing one of the preset buttons after power up recalls the settings last stored in that memory. A power up hard reset facility is available to clear the memories back to the default settings.

Settings which are Stored

- Channel FILTER select switches
- Filter TYPE switches HPF, BPF, LPF
- LFO ON switch
- LFO x2 switch

Settings which are Not Stored

- RESONANCE control
- VCF slider FREQUENCY
- VCF slider LFO DEPTH
- LFO speed (tempo)

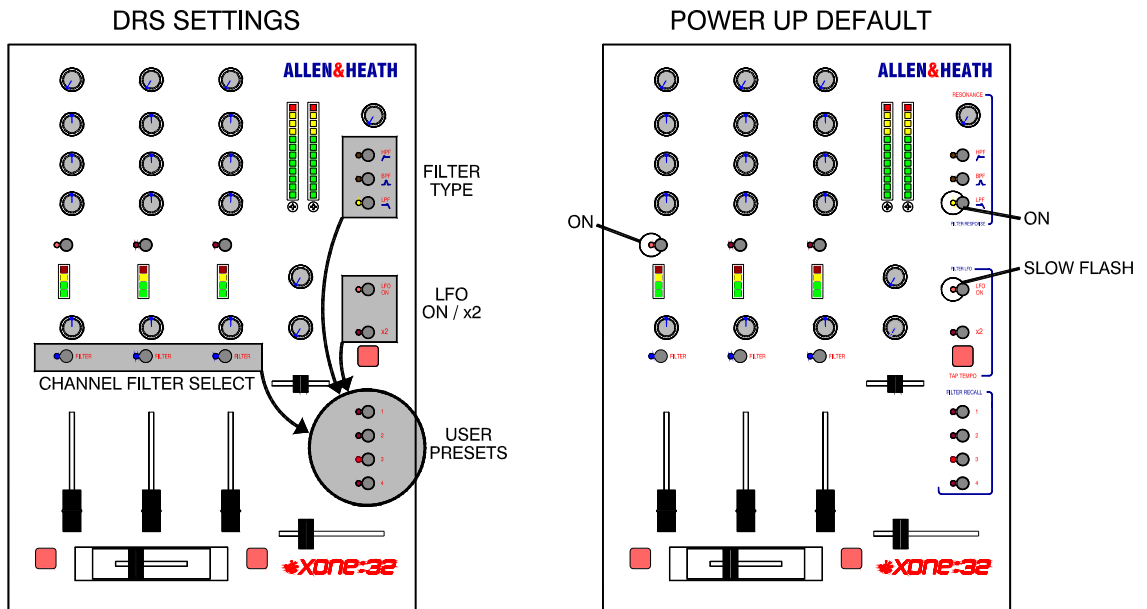

How to Store a Preset

Press and hold the preset button for 2 seconds until its red indicator flashes once to confirm the current settings have been stored. When you release the button that preset remains selected.

How to Recall a Preset

Press the preset button for less than 1 second. Its red indicator lights to indicate the console settings have been overwritten with the contents of the memory.

How to Clear all Presets to Default

Hold down the LFO ON and x2 switches for 2 seconds while switching the console on. This clears the presets back to the factory default. Note that you do not normally need to do this as you can clear individual presets by setting the switches as per default and then storing each individually. Remember to turn the amplifiers off while you switch the console on or off.

Specifications

0dBu = 0.775 Volts rms, +4dBu = 1.23V rms 0dBV = 1 Volt rms, -10dBV = 316mV rms

Max output level	TRS +21dBu into >2k ohm RCA +15dBu into >10k ohm	Music EQ	3-Band +6/-26dB 100Hz, 1kHz, 10kHz
Headroom	Channels +21dB Mix to output +23dB	Mic EQ	2-Band +/-10dB 300Hz, 5kHz HPF 60Hz
Freq response	+0/-1dB 10Hz to 30kHz	Ch fader	60mm stereo
Distortion	< 0.02% THD+N @1kHz +10dBu	Crossfader	45mm stereo VCA Dual rail, gold contacts Replaceable, P&G option
Crosstalk	< 90dB Channel shutoff @1kHz	Filters	Stereo analogue VCF HPF, BPF, LPF types 100Hz to 20kHz sweep
MIC EIN 22-22kHz	-126dB 150 ohm source	LFO	Finger tap tempo entry Depth modulation of VCF x2 Multiplier
Residual noise	TRS -102dBu RCA -92dBu		
Mix noise	TRS -87dB		
Ch meters	Peak reading 4 led -15, 0, +5, +8 (PK)		
Main meters	Peak reading 12 led -20 to +8 (PK)		

Power Supply

Internal switch mode power unit with auto sensing mains input.

MAINS IN socket	IEC 3 pin
Power lead	Country dependent with moulded mains plug supplied
AC mains	100 to 240V AC @ 50/60Hz
Consumption	30W max
Mains fuse rating	100-240V AC T500mA 20mm

Dimensions and Weights

The console is fitted with rubber feet for desktop operation. An optional screw on rack ear kit is available for rack or plinth mounting. This is fixed in place using M6 screws or bolts. Contact your Allen & Heath agent for further information. The order code for the kit is: **XONE:32-RK**

	Width	Height	Depth	Weight
Desktop	257 mm (10.1")	89 mm (3.5")	358 mm (14.1")	4 kg (9 lbs)
Rack ears fitted	307 mm (12.1")	89 mm (3.5")	358 mm (14.1")	
Packed	475 mm (18.7")	210 mm (8.3")	395 mm (15.6")	5 kg (11 lbs)

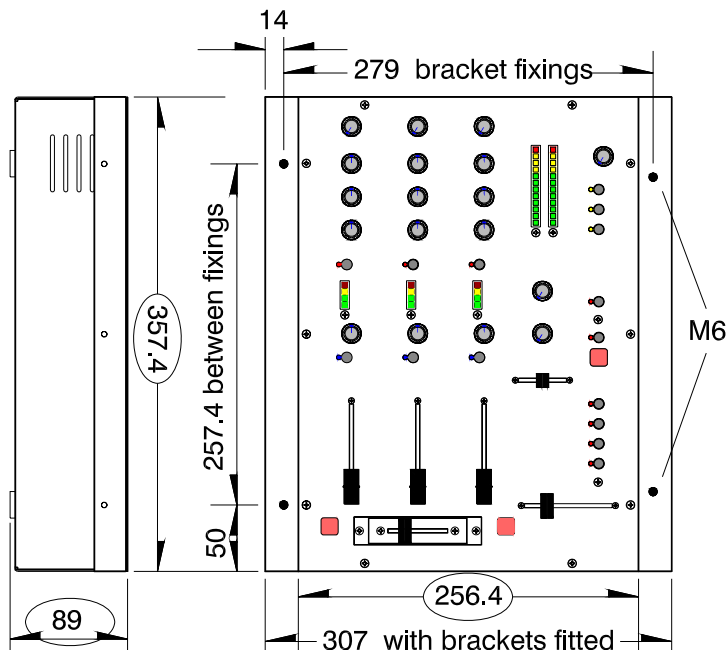

XONE:32 BLOCK DIAGRAM

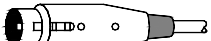
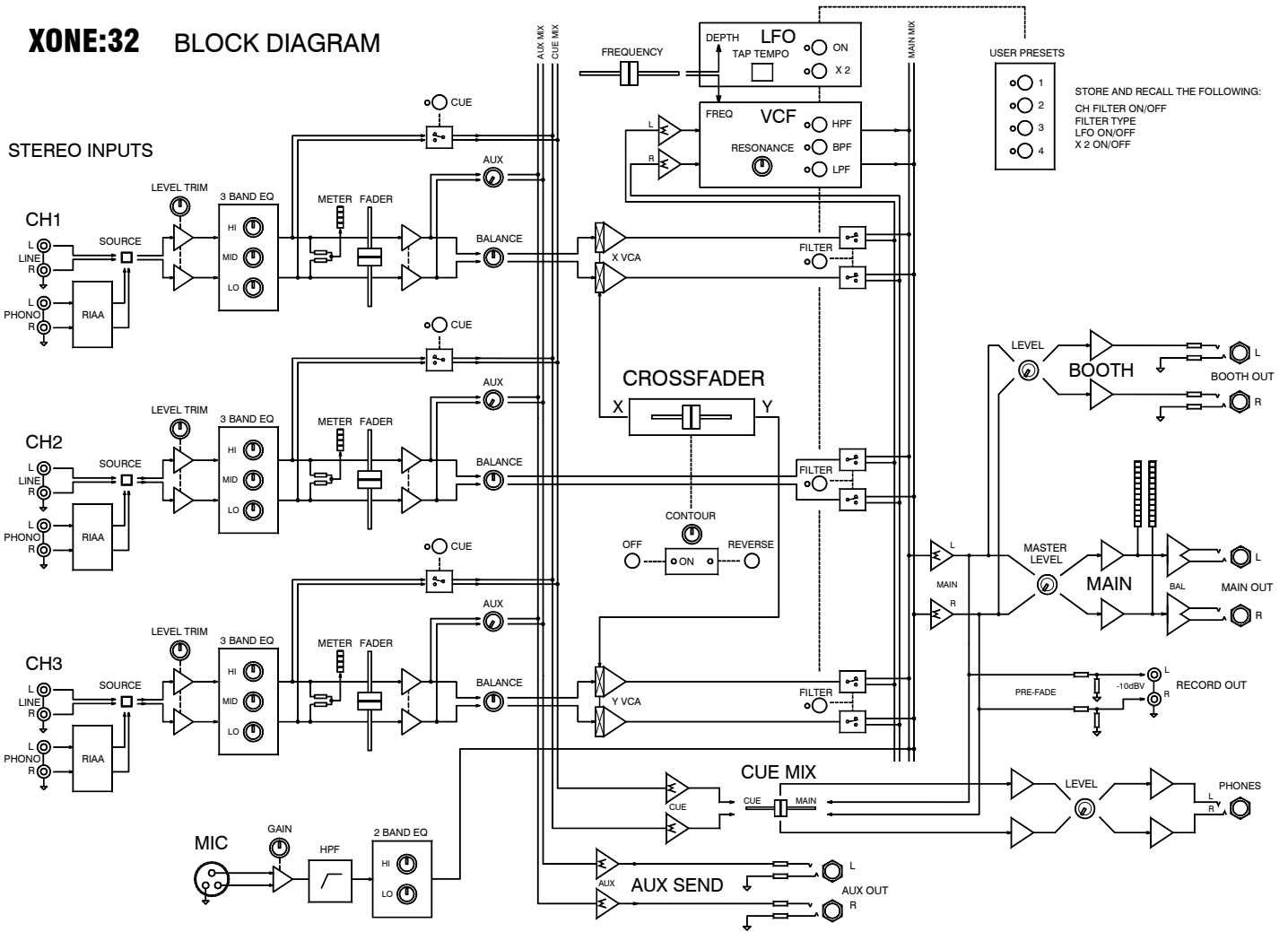

Connector Types

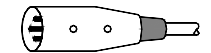

XLR connector : Pin 2 = hot (+) Pin 3 = cold (-) Pin 1 = GND
 TRS input and output connectors : Tip = hot (+) Ring = cold (-) Sleeve = GND
 RCA PHONO pin connectors



Input Connections

	Type	Impedance	Sensitivity
MIC IN	Balanced XLR female	2k ohm	-45 to -15dBu
Stereo LINE IN	RCA phono	>10k ohm	-15 to +15dBu
Stereo PHONO IN	RCA phono RIAA	47kohm/330pF	2 to 100mV

Output Connections

	Type	Impedance	Level
MIX OUT L,R	Electronically balanced TRS jack	<75 ohm	0dBu
BOOTH OUT L,R	Impedance balanced TRS jack	<75 ohm	-2dBu
AUX OUT L,R	Impedance balanced TRS jack	<75 ohm	-2dBu
RECORD OUT L,R	RCA phono	<600 ohm	-10dBV
HEADPHONES	Tip = L Ring = R	30 to 600 ohm, 70 ohms recommended	

Glossary

The following section is included to help you understand some of the technical terms and jargon referred to with consoles of this type. It is by no means a complete reference. Please refer to specialist audio publications should you wish to know more.

Amplitude Another term used for signal level.

Asymmetric EQ An equaliser with a different amount of cut and boost of the frequency bands. This is used to restrict the available boost so preventing system overload while providing extended cut to allow dramatic performance effects by 'killing' selected frequencies.

Attenuate Reduce the signal level.

Aux Auxiliary. An independent mix derived from the channels for various functions. This can be set pre (before) or post (after) the channel fader. Pre-fade sends are often used for foldback monitor feeds. Post-fade sends are often used for sampler, reverb and other effects, zone and special recording feeds.

Balanced, Unbalanced Refers to the type of input or output signal connection. An unbalanced connection has two signal carrying conductors, one of which is the cable shield. A balanced connection has three conductors, two for signal and a shield which is connected to earth. Because the signal conductors are at the same impedance and of opposite polarity they are better able to cancel and therefore reject interference and noise pickup. It is standard practice to use balanced connections for long cable runs, for example to amplifiers, or cables carrying sensitive or low level signals, for example microphones.

Bandpass (BPF) A filter with a bell-shaped response for attenuation of frequencies either side of the centre frequency.

Beat Mixing Using the variable pitch controls on turntables/CD players to synchronise the rhythm track of two separate songs, so that the beat remains constant when smoothly cross-fading from one to the other.

Bi-amping Providing separate amplifiers to drive the high and low frequency units in a loudspeaker. This requires a crossover processor that splits the frequency band into low and high. Bi-amping usually produces a cleaner and more controllable sound in larger systems.

BPM Beats Per Minute. The measurement of the rhythmic beat or tempo of the music.

Booth The area, often enclosed, where the DJ operates. Usually provided with local booth monitor loudspeakers.

Cardioid The response of a microphone which is more sensitive in front than behind. This is generally used for vocal miking to reduce acoustic feedback.

Cut Mixing Moving the cross-fade control sharply from one side to the other, to either pick out a sound, a hi-hat, kick drum etc, or to drop straight into another record. Also known as chopping.

Cartridge The pickup in a turntable. Uses a needle to pick up vibrations from the record (vinyl) and convert this to electrical signals that feed the console. The cartridge is usually fitted to a removable headshell that plugs into the turntable arm.

Clipping The harsh distorted sound that results when the signal hits the maximum level possible. This is set by the power rail voltage. Above this there is simply no more voltage available so the signal is 'clipped'.

Compact Disc (CD) Well established stereo player using digitally mastered pre-recorded flat discs. Becoming

popular with DJs as a replacement or alternative to vinyl mixing. Recordable CDs are now available.

Contour The term used to describe the 'law' of a fader, how quickly it responds as it is moved, or the amount of fade per unit of movement. The contour control associated with a crossfader lets the DJ tailor its response to suit the preferred mixing style.

Crossfader A short horizontally mounted fader for smoothly fading one music track in while fading the other out. Often used by the DJ for cutting and layering sounds while mixing.

Cue A monitor system provided for the DJ or console operator to check individual channel signals using headphones while lining up tracks ready to introduce into the mix. This does not affect the main console outputs.

DAT Digital Audio Tape. A type of digital 2 track recorder that uses a small tape cartridge to produce high quality recordings in a compact format.

dB Decibel. The unit of measurement for audio signal level. This is logarithmic to follow the response of the human ear. 'dB' is a relative measurement to compare one level with another, for example gain from input to output. 'dBu' is an absolute measurement referenced to a voltage standard where 0dBu = 0.775V rms. The console main outputs operate at 0dBu = '0' reading on the meters. 'dBV' is a similar measurement but refers to a 1V standard. It is common for consumer equipment to operate at the 'low' standard of -10dBV (316mV). 'dBA' refers to sound pressure level and is measured using the 'A' scale that 'hears' in the same way as the human ear.

DJ Disc Jockey. The console operator sequencing and playing the music tracks. Some simply play the tracks, others talk over with introductions and announcements, and others provide an entertaining performance by mixing and shaping sounds to create a completely different musical experience.

DRS™ Digital Recall System. Unique to Allen & Heath this provides user programmable memories for instant recall of favourite settings.

Drum Machine An electronic drum simulator as used by keyboard players and in electronic music. This now provides another DJ tool to create an alternative beat to mix in with the music.

Dynamic Range The difference expressed in dB between the highest and lowest signal levels possible. This is limited by the clipping level and residual noise floor respectively.

Earth Also known as 'ground'. The term for the electronic signal reference. This connects to the mains supply earth point and all cable shields and conductive equipment cases. It provides the return for the signal voltage within the equipment. It also ensures operator safety by removing the possibility of electric shock should the mains voltage touch any metal part.

Earth (ground) Loop The result when the equipment sees more than one path to the system earth. Current flows because a resistive loop susceptible to radio and mains interference is formed. In severe cases this can result in audible hum or buzz in the system. Breaking the

loop by removing all but one path to earth usually solves the problem.

Equaliser (EQ) This provides cut or boost of selected frequencies (equalisation) for tonal shaping of the sound. This is similar to the bass and treble controls of domestic hi-fi amplifiers. However, **XONE:32** provides 3 independently controllable frequency bands for corrective or effective sound shaping.

Feedback Also known as 'howlround' or 'ringing' this is the rapidly increasing tone produced when a microphone picks up its own signal from the speakers. It is usually a shrill and annoying squeal that should be quickly dealt with by repositioning the microphone or speakers, reducing mic gain or equalising the system to notch out the offending frequencies.

Gain This is the boost or attenuation applied to the source signal in the channel preamp stage to match it to the console operating level. For example, a large amount of gain is needed to match low microphone signals. It is set using the console meters. Gain is not used for level (volume) control.

Headroom The amount of level available expressed in dB to handle peaks above the normal 0dB operating level.

Hertz (Hz) The measurement of frequency. The audio spectrum ranges from a low (bass) frequency of 20Hz to a high (treble) 20kHz. Not many sound systems reproduce the full range. Average hearing does not extend much beyond 15kHz or so. Response is further impaired if the ear is subjected to continual high sound pressure levels.

Highpass (HPF) A filter that attenuates frequencies below the cut-off frequency.

Hum Apart from not knowing the words... this is the audible noise that usually results from mains interference pickup, earth loops, bad interconnections and induced power supply and lighting fields. It is usually at mains frequency (50/60Hz) or a related harmonic.

Impedance (Z) A technical term for the resistance of a signal conductor to ground. Low impedance usually refers to microphones of 200 ohms or less, and line signals typically less than 100 ohms. Low Z sources are less prone to interference pickup. Inputs are usually high impedance so that one source can connect to more than one channel without signal loss. Note that the operating impedance of a connection is set by the impedance of the source, not that of the unconnected input.

Impedance balanced Refers to the type of output signal connection. It has three conductors, two for signal and a shield which is connected to earth. Provides interference rejection similar to a fully balanced connection because the two signal conductors are matched at the same impedance. However, the drive capability is less because the signal is carried by only one conductor.

LFO Low Frequency Oscillator. Generates a repetitive control voltage at a user determined rate (speed) to automatically modulate an effect such as the VCF.

Limiter A signal processor that limits the maximum level possible by preventing the signal going over a predetermined threshold level. This is very useful in club installations where it is inserted between the console and house system amplifiers to prevent the DJ exceeding the maximum allowable volume.

Lowpass (LPF) A filter that attenuates frequencies above the cut-off frequency.

MC Master of Ceremonies. The presenter who introduces the performances and maintains the running order. Also refers to a rapper who talks in time to the beat.

MiniDisc A type of low cost digital 2-track recorder that uses a disc similar to but smaller than that used by computers. It uses a compression algorithm and is able to record up to 74 minutes of stereo material. It is regarded as the modern replacement for the audio cassette recorder. It has the added facility to label and edit tracks.

Mono A single source with no stereo content, or the left and right stereo signals summed together as one.

Mute To turn off the signal. Transform is a mute effect.

Noise Generic term for an unwanted signal. This may be residual electronic hiss, hum, buzz, clicks and pops, or simply loud undesirable music.

Noise Floor This is the term for the residual electronic noise produced by all powered audio equipment. It usually sounds like a constant hiss, although some equipment may suffer from residual hum as well.

Omni-directional The response of a microphone which picks up sounds equally all round. Not suited to live vocal applications as they are more prone to feedback.

Pan Panoramic. A control that adjusts the balance of the signal in the left and right speakers.

Peak Meter A type of signal meter that has a very fast attack and slower release. This picks up the fast signal transients and holds them long enough for the operator to see the activity on the display. These meters typically use LED (light emitting diode) displays.

Phantom Power The DC voltage required by certain microphones to power the capsule. These are usually sensitive studio grade mics not suited to DJ mixing. The power is provided by the console using the two signal conductors in the balanced connection. There is no provision on **XONE:32** for this type of microphone.

Phono Abbreviation for phonograph as in 'turntable'. Usually means RIAA equipped input when marked on console inputs. Can also refer to the RCA 'phono' type pin jack connector found on turntables, CDs and much domestic equipment.

Polarity Sometimes referred to as 'phase' this is the + / - sense of a balanced signal or loudspeaker connection. Reversed polarity should be avoided and checked for as it can cause uncomfortable phasing effects as the listener moves between the speakers.

Punch Performance effect popular with DJ's. Pressing a button next to the crossfader punches in (turns on) the opposite track.

Resonance Applied to the filters this is the effect of accentuating frequencies around the cut-off point to produce subtle or dramatic phasing effects.

RIAA Record Industry of America Association, responsible for the long established equalisation standard that is applied to the signal produced by a turntable cartridge. Due to the physics of vinyl reproduction the needle produces a reasonable high frequency signal but much less low frequency. An RIAA pre-amplifier compensates for this by inversely attenuating the high and boosting the low frequencies.

Reverberation The way in which sound reflects and bounces around the room after the source is removed. This depends on the size and shape of the room as well as the materials such as carpets, curtains and clothing that absorb certain frequencies.

Reverb Effect This is a signal processor that connects to the console to artificially simulate the reverb effect. Parameters such as decay time, diffusion and amount of reverb can be controlled. Typically selected sounds are sent to the processor by turning up the channel post-fade

aux sends. The processed (wet) signal is returned to the mix through a channel where it adds to the direct (dry) signal routed from the channel fader.

RPM Revolutions Per Minute. The measurement of turntable speed, eg. 33, 45 RPM

Sampler Another performance effect popular with DJs. The channel signal is sent to a digital processor that samples (stores) a short duration of sound. The output is returned through a channel and replayed by pressing a trigger. Many samplers provide creative effects such as repeat and reverse.

Scratch Mixing The art of rhythmically rocking a record back and forward on a turntable, to repeat a certain sound, a vocal or tone, at the same time operating the cross-fader to create a syncopated "wah wah" chirp added over a bass heavy back beat.

Signal-to-Noise Ratio (SN) This is the difference expressed in dB between the normal 0dB operating level and the residual noise floor. It represents how far above the equipment hiss level the signal operates. More is better.

Slipmat A fabric turntable mat positioned under the record so that the DJ can hold it stationary ready to let go for a fast start at the point cued.

Sound-to-Light A processor that converts an audio signal into a control voltage that triggers lighting effects. This produces the popular disco effects with lights flashing in time to the beat.

Split Cue A facility to listen to the cue signal in one ear while keeping the program in the other. Used for matching the beat while cueing a new track. Some consoles provide a CUE/MIX fader to preview the mix before going live.

Sub Bass A loudspeaker designed to reproduce only very low frequency sound, typically from around 30 to 120Hz. A crossover is used to route only the low frequencies to the sub.

Tempo The rhythmic beat of the music, usually referred to in BPM (Beats Per Minute). The DJ can tap the tempo into the LFO so that its speed is in time with the music.

Transform Performance effect popular with DJ's. Pressing a button next to the crossfader mutes (turns off) the active music. Used for 'stutter' effects.

Transmute A new Allen & Heath function that combines the popular punch transform and punch effects into one 'intelligent' button.

TRS Jack Refers to the 3-pole (stereo) ¼" jack plug with Tip, Ring and Sleeve connections.

TS Jack Refers to the 2-pole (mono) ¼" jack plug with Tip and Sleeve connections. TS cables can plug into the **XONE:32** impedance balanced outputs without modification.

Turntable Otherwise known as a 'record deck' this plays vinyl discs, still the most popular source for DJ mixing. It is common for the cartridge to plug directly into the mixing console 'phono' input which provides the RIAA equalisation required. The turntable usually has variable speed control so that the DJ can synchronise the beat between tracks.

VCA Voltage Controlled Amplifier. An audio gain element whose level is controlled by a remote DC voltage rather than through a fader or rotary control.

VCA Crossfader Functions as an audio crossfader but with the audio level controlled by a DC voltage produced by the fader. This voltage can be electronically filtered and is therefore able to remove the clicks, scratches and drop-outs associated with worn audio faders.

VCF Voltage Controlled Filter. An audio filter whose cut-off frequency is controlled by a remote DC voltage rather than a rotary or switched control. This provides greater range and capability. The circuit used in the **XONE:32** produces the dramatic sound of the classic analogue synthesiser filter.

XLR The professional standard 3 pin round connector used for microphone and other balanced connections. Equipment female sockets are for inputs, male for outputs.

Order Codes

The following products and parts can be ordered from Allen & Heath or the approved dealer:

XONE:32/v	XONE:32 3 stereo channel mixer	/v = specify voltage
XONE2:62/v	XONE:62 6 stereo channel mixer	/v = specify voltage
XONE2:464/v	XONE:464 4 mic 6 stereo channel mixer	/v = specify voltage
002-684	60mm Stereo Channel Fader for XONE:32, 62 & 464	
002-719	Optional P&G crossfader for XONE:32, 62 & 464	
002-720	Standard crossfader for XONE:32	
002-722	30mm Cue/Mix fader for XONE:32	
002-723	60mm VCF/LFO depth fader for XONE:32	
XONE:32-RK-SG	Plinth mounting rack ear kit	
AP4264	XONE:32 User Guide	
AP4265	XONE:32 Service Manual	

Tips and Troubleshooting



For your safety do not remove the **EARTH** (ground) connection in the power lead of the console or connected equipment.



Have your **MAINS SYSTEM** checked by a qualified electrician. If the earthing is solid to start with you are less likely to experience problems.



Use high grade **AUDIO CABLES** and check them for reliable connection. It is well known that many audio system problems are due to faulty cables and connectors.



In a club or similar installation strict **SOUND LEVEL** and noise regulations may apply. Check that your system levels are correctly set up to comply.



To avoid damage to your hearing start with the **HEADPHONES** level control at minimum and turn up only as much as is needed to maintain comfortable listening level. Do not drive headphones at high listening levels for long periods of time.



Always switch connected **AMPLIFIERS** on last and off first to avoid thumps when the console and connected equipment is turned on or off.



Reduce gain if the red meter **PEAK** led flashes. These warn you that you are near clipping which may result in system overload and distortion. The **XONE:32** provides plenty of drive and headroom when operated around the 0 to +5 meter points. Check that the amplifier / speaker system is correctly matched and set up for correct levels.



Increasing **VCF RESONANCE** boosts a narrow band of selected frequencies. Make sure you reduce the channel gain if the red peak meters start to flash. It is best to start experimenting with this control set to minimum.



If you suspect a console fault. The console is the heart of the audio system and is often suspected faulty when a problem occurs. Usually the fault is found to be with other equipment in the system, typically the interconnecting leads, input sources, or level matching between equipment. Check for source problems by unplugging each channel in turn listening for a change in symptom. To check the console, isolate it by unplugging all sources and outputs leaving just headphones and a reference source such as a CD player connected.



I have plugged in a microphone but it does not work. The **XONE:32** is designed to operate with non-phantom powered dynamic microphones such as the popular vocal types. Do not use microphones which require phantom power. If it has an on/off switch check that it is turned on. Make sure the front panel **GAIN** control is turned up.



The signal sounds very distorted with high level and excessive bass. Only plug turntables needing RIAA equalisation into the **PHONO** inputs. Other equipment should be plugged into the **LINE** inputs.



There is a hum on the turntable channels. Check that the turntable earth strap has been correctly connected

to the console chassis earth post. Also check that the turntable headshell and cartridge are correctly aligned and plugged in.



The output meter reads fine but the signal is distorted. Check the channel meter to make sure it is not peaking red. If it is, the output meter may still read fine if the fader or master level control is not set fully up. Reduce the input level trim if the channel meter reads too high.



Only one side of the stereo mix is working. Check that the **BAL** control is not set fully to either L or R. Also check for bad connections, in particular **RCA** phono leads and turntable headshell and cartridge pins.



There is feedback. Check that the microphone is not placed next to the headphones or loudspeakers. The mic may pick up its own signal and feed back. In loud listening conditions feedback can sometimes be caused by mechanical vibration through the turntables into the cartridge, or even the needle resting on a cued turntable starting to resonate in the groove of the record.



When the VCF is switched on there is very little sound. Operate the **VCF** frequency slider to restore the frequency content of the sound.



The LED is flashing but the LFO is not working. Check that the **LFO** is turned on and its LED is green, flashing red to indicate speed. The LED always flashes red whether it is on or off.



I tap in the tempo but the LED flashes too fast. The **x2** has been switched on.



There is no cue signal. Check that the **CUE/MIX** slider is not set fully right for mix only.



There is no channel signal. Check that the rear panel input selector switch is correctly set.



The crossfader is not working. Make sure the crossfader is turned on and its front panel green LED lit.



The crossfader works backwards. Check that the reverse switch has not been pressed and its red LED on. If it is off then check that the crossfader has been re-fitted the right way round if previously removed.



I have connected a stereo source to a single input using a Y-adaptor but it sounds bad. Do not connect more than one output to the input. These adaptors are designed to feed one output to two inputs, not the other way round.



The switch settings are different when I switch the console on. The settings always return to default on power up. You can store preferred settings in the user presets and select one of these after power up.

Check out my Internet site :

<http://www.xone.co.uk/>