

Classis GM 313 | GM 315

Gooseneck Microphones



FEATURES

- Highest audio quality
- Sturdy and robust 6 mm gooseneck
- RFI-proof due to Scudio technology
- High sensitivity
- Excellent high gain before feedback
- Unobtrusive due to small dimensions
- Non-glare surface

APPLICATIONS

The gooseneck microphones of the Classis series integrate cardioid electret microphones inside the very small microphone head. They can be used for all kinds of applications where a high-quality, but also discrete microphone is demanded.

The LED ring displays the ready-to-talk status of the microphone. Due to the cardioid polar pattern this microphone has a high gain before feedback and provides highest intelligibility of speech. Therefore, the microphones are ideal for the use with lecterns, sound reinforcement applications, conferencing, high quality talk-back and paging systems.

All microphones feature the innovative Scudio technology, making the microphones absolutely insensitive to wireless communication devices such as mobile phones.

The microphone is mounted on a 6 mm thick gooseneck and due to its mat black, non-glare surface almost invisible.

The microphones can be powered with any phantom power source supplying 8 to 52 volts.

With the SP variants you can select via the programmable button between the operating modes ON/OFF, Push-To-Talk and Push-To-Mute. The microphone button can also be disabled. The frequency response can be set with a separate switch in two stages: Linear or with low-cut filter to suppress low-frequency interference. The illuminated ring indicating the microphone status can be deactivated.

In addition to the features of the SP variants, the RC variant provides the option of external control. Furthermore, when operating the microphone button, an external device can be controlled via the control output.

- With LED ring
- 8 - 52 V phantom power
- SP variant with programmable button, switchable low-cut filter and switchable LED ring
- RC variant, same as SP variant, but in addition to this with remote control function

VERSIONS

Classis GM 313 SP 3-pin XLR plug, 300 mm [12"], phantom power adapter, programmable button (PTT, PTM, ON/OFF) with braille, switchable low-cut filter, switchable LED ring. Order # 729.787

Classis GM 315 SP same as above, but 500 mm [19.69"]. Order # 729.795

Classis GM 315 5-pin XLR plug, 500 mm [19.69"], LED ring. Order # 722.456

Classis GM 315 E 5-pin XLR plug, 500 mm [19.69"], LED ring, without preamp, for installation with MCS 563 L, MCS 553 L, MCS-D 3643, incl. wind shield. Order # 489.565

Classis GM 315 RC 5-pin XLR plug, 500 mm [19.69"], phantom power adapter, programmable button (PTT, PTM, ON/OFF) with braille, switchable low-cut filter, switchable LED ring, remote control function. Order # 729.809

Classis GM 313 | GM 315

TECHNICAL SPECIFICATIONS

Operating principle.	Pressure gradient
Polar pattern.	Cardioid
Frequency response.	50 - 19,000 Hz
Open circuit voltage.	17 mV/Pa
Nominal impedance.	< 200 Ω
Load impedance.	\geq 1 k Ω
Signal to noise ratio / noise voltage.	69 dB [A] / 6.0 μ V [A]
Max. SPL.	107 dB [SPL @ 1% THD]
Equivalent SPL.	25 dB [A]
Wiring GM 31x SP.	3-pin male XLR
Wiring GM 315/313 RC.	5-pin male XLR
Wiring GM 313/315 T.	bal. 2.5 m [8.2 ft] long connecting cable with 4-pin female mini XLR connector for CVE 305.18 with 3-pin XLR connector
Supply voltage GM 31x.	Phantom power 8 - 52 V
Supply voltage GM 31x SP / RC.	Phantom power 8 - 52 V
Current consumption GM 31x.	2 mA
Current consumption GM 31x SP / RC.	9 mA
Current consumption LED ring with internal resistor of 500 Ω at 5 V supply voltage.	6 mA
at 12 V supply voltage.	20 mA
Dimensions	
Length.	depending on the version
Head diameter.	13.6 mm [0.5"]
Gooseneck diameter.	6 mm [0.2"]
Shaft diameter.	20 mm [0.8"]
Weight.	depending on the version

Classis GM 315 E

Transducer type.	Electret condenser
Operating principle.	Pressure gradient
Polar pattern.	Cardioid
Frequency response.	50 - 19,000 Hz
Open circuit voltage.	17 mV/Pa*
Signal to noise ratio / noise voltage.	69 dB [A] / 6,0 μ V [A]*
Max. SPL.	107 dB [SPL @ 1% THD]*
Equivalent SPL.	25 dB [A]*
Wiring GM 31x.	5-pin XLR connector

SUPPLIED ACCESSORIES

WS 302 B	Wind shield for Classis GM series, black.	Order # 722.782
----------	--	-----------------

Current consumption LED ring with internal series resistor of 500 Ω at 5 V supply voltage.	6 mA
at 12 V supply voltage.	20 mA
Electrical parameters of the capsule with 2-pole connection without the CVE 305.18 power supply unit:	
Supply voltage.	1.5 - 10 V
Series resistor (recommended).	2.2 kohms
Sensitivity.	approx. -47 dBV/Pa
Dimensions	
Length.	depending on the version
Head diameter.	13.6 mm [0.5"]
Gooseneck diameter.	6 mm [0.2"]
Shaft diameter.	20 mm [0.8"]
Weight.	depending on the version

Classis GM 315 RC additional functions

External operating button.	Switching to ground
MOSFET switching output.	< 10 Ω with microphone I < 100 mA; U < 30 V

MOSFET switching output

Pin 4 is a MOSFET switching output to control external devices. When the microphone is activated the output is low-resistance to ground (< 10 Ω). In the "Remote only" mode this output controls the microphone button. As long as this button is pressed, the output is pulled to ground. In principle, DC signals can be switched, the maximum current is 100 mA, the maximum voltage is 30 V. With larger loads, the output can be used to control an additional circuit breaker.

*measured with CVE 305.18 power supply

OPTIONAL ACCESSORIES

GMS 52	Shock-mounted holder for table installations, 5-pin female XLR connector.	Order # 729.434
ZSH 20	Shock-mounted holder for desktop installation.	Order # 454.559

Classis GM 313 | GM 315

WIRING DIAGRAMS

Classis GM 315

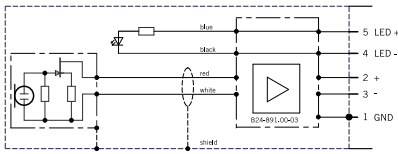

Classis GM 315 SP

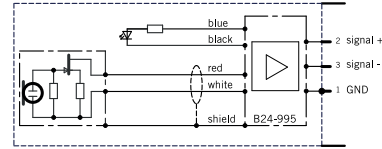

Classis GM 315 E

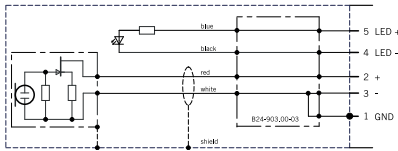

Classis GM 315 RC

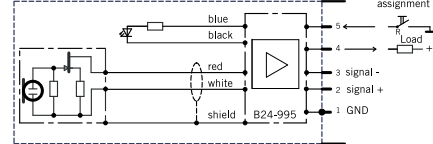

FREQUENCY RESPONSE & POLAR PATTERN

This frequency response curve (measuring tolerance ± 2.5 dB) and polar pattern correspond to a typical production sample for this microphone.

Frequency response curve ± 2.5 dB

0 dB $\hat{=}$ 17 mV/Pa

Classis GM 315

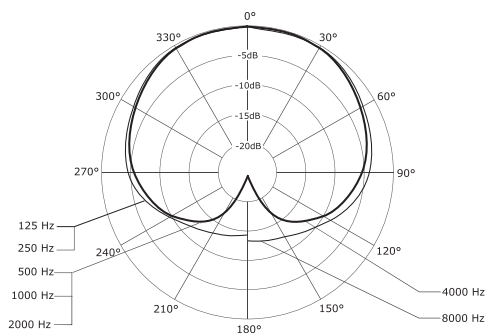
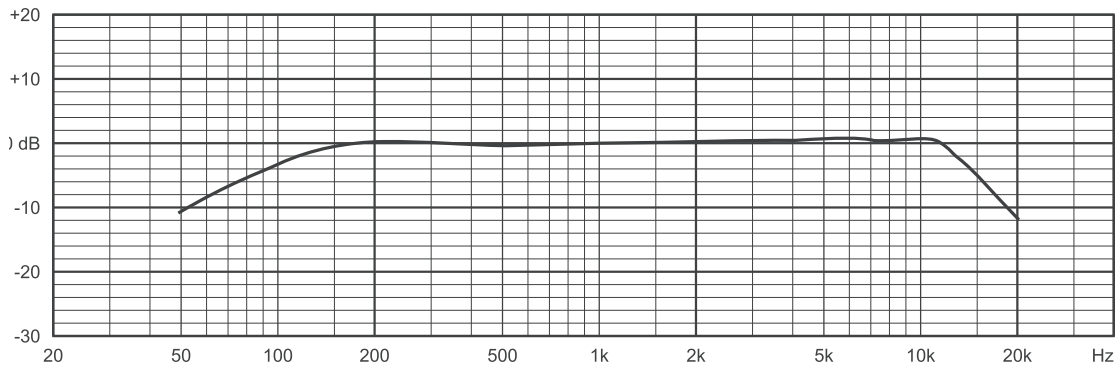

Classis GM 313 | GM 315

DIMENSIONS

Classis GM 315

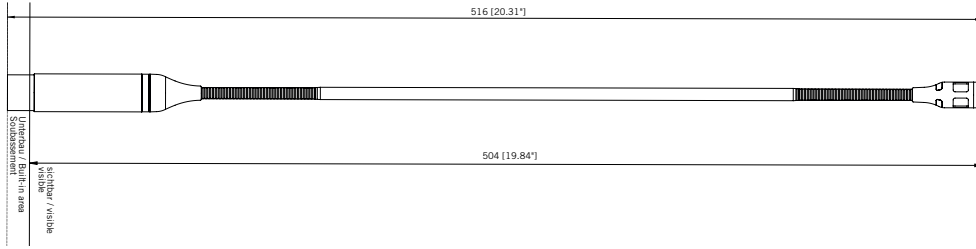

Classis GM 313 SP

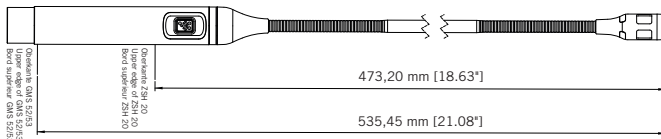

Classis GM 315 SP

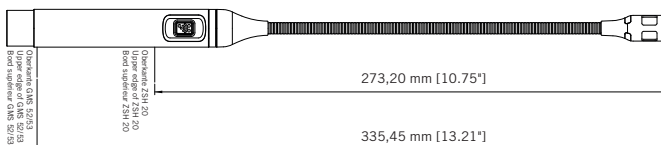

ARCHITECT'S AND ENGINEER'S SPECIFICATIONS

The cardioid electret condenser microphone shall be used for high-quality conference, paging and PA applications. A filter in the microphone grille shall suppress wind and pop noise. A programmable button shall operate in the operating modes ON/OFF, Push-To-Talk and Push-To-Mute. The microphone button shall be disabled when needed. The frequency response shall be selectable in two stages: linear or with low-cut filter to suppress low-frequency noise. The LED ring to display the microphone status shall be deactivated when needed. The LED ring integrated in the microphone head shall illuminate red to display the ready-to-speak status of the microphone. The microphone shall have an excellent RFI shielding and is immune to wireless communication devices. The conference microphone shall operate with phantom power P12, P24 or P48. A preamp with electronically balanced signal output shall be integrated in the base. The gooseneck shall be 6 mm [0.24"] thin, black, free from reflection and completely made of metal. It shall be used for round table discussions, panel discussions, tele/video conferences, paging and lecterns. The microphone head shall have a diameter of 13.6 mm [0.54"]. The total length from the connector to the microphone shall be 335 mm [13.19"]. The frequency response shall be 50 to 19,000 Hz. The open circuit voltage shall be 17 mV/Pa. The nominal impedance shall be 200 ohms. The microphone shall be provided with a 3-pin XLR connector (male). The net weight shall be 0.132 kg [0.29 lbs].

Manufacturer: beyerdynamic
Type: Classis GM 313 SP

The cardioid electret condenser microphone shall be used for high-quality conference, paging and PA applications. A filter in the microphone grille shall suppress wind and pop noise. A programmable button shall operate in the operating modes ON/OFF, Push-To-Talk and Push-To-Mute. The microphone button shall be disabled when needed. The frequency response shall be selectable in two stages: linear or with low-cut filter to suppress low-frequency noise. The LED ring to display the microphone status shall be deactivated when needed. The LED ring integrated in the microphone head shall illuminate red to display the ready-to-speak status of the microphone. The microphone shall have an excellent RFI shielding and is immune to wireless communication devices. The conference microphone shall operate with phantom power P12, P24 or P48. A preamp with electronically balanced signal output shall be integrated in the base. The gooseneck shall have two flexible 6 mm [0.24"] thin elements with a rigid tube in between. The housing shall be black, free from reflections and completely made of metal. It shall be used for round table discussions, panel discussions, tele/video conferences, paging and lecterns. The microphone head shall have a diameter of 13.6 mm [0.54"]. The total length from the connector to the microphone shall be 535 mm [21.06"]. The frequency response shall be 50 to 19,000 Hz. The open circuit voltage shall be 17 mV/Pa. The nominal impedance shall be 200 ohms. The microphone shall be provided with a 3-pin XLR connector (male). The net weight shall be 0.132 kg [0.29 lbs].

Manufacturer: beyerdynamic
Type: Classis GM 315 SP

Classis GM 313 | GM 315

ARCHITECT'S AND ENGINEER'S SPECIFICATIONS

The cardioid electret condenser microphone shall be used for high-quality conference, paging and PA applications. A filter in the microphone grille shall suppress wind and pop noise. A programmable button shall operate in the operating modes ON/OFF, Push-To-Talk and Push-To-Mute. The microphone button shall be disabled when needed. The frequency response shall be selectable in two stages: linear or with low-cut filter to suppress low-frequency noise. The LED ring to display the microphone status shall be deactivated when needed. The LED ring integrated in the microphone head shall illuminate red to display the ready-to-speak status of the microphone. The microphone shall have an excellent RFI shielding and is immune to wireless communication devices. The microphone shall be externally turned on or off. Another control output shall control an external device when operating the button. The conference microphone shall operate with phantom power P12, P24 or P48. A preamp with electronically balanced signal output shall be integrated in the base. The gooseneck shall have two flexible 6 mm [0.24"] thin elements with a rigid tube in between. The housing shall be black, free from reflections and completely made of metal. It shall be used for round table discussions, panel discussions, tele/video conferences, paging and lecterns. The microphone head shall have a diameter of 13.6 mm [0.54"]. The total length from the connector to the microphone shall be 535 mm [21.06"]. The frequency response shall be 50 to 19,000 Hz. The open circuit voltage shall be 17 mV/Pa. The nominal impedance shall be 200 ohms. The microphone shall be provided with a 3-pin XLR connector (male). The net weight shall be 0.132 kg [0.29 lbs].

Manufacturer: beyerdynamic
Type: Classis GM 315 RC

The cardioid electret condenser microphone shall be used for high-quality conference, paging and PA applications. A filter in the microphone grille shall suppress wind and pop noise. The LED ring integrated in the microphone head shall have an external supply. The microphone shall have an excellent RFI shielding and is immune to wireless communication devices. The conference microphone shall operate with phantom power of 8 to 52 V. A preamp with electronically balanced signal output shall be integrated in the base. The gooseneck shall have two flexible 6 mm [0.24"] thin elements with a rigid tube in between. The housing shall be black, free from reflections and completely made of metal. The microphone head shall have a diameter of 13.6 mm [0.54"]. The total length from the connector to the microphone shall be 516 mm [20.31"]. The frequency response shall be 50 to 19,000 Hz. The open circuit voltage shall be 17 mV/Pa. The nominal impedance shall be 200 ohms. The microphone shall be provided with a 5-pin XLR connector (male). The net weight shall be 0.156 kg [0.34 lbs].

Manufacturer: beyerdynamic
Type: Classis GM 315

The cardioid electret condenser microphone shall be used for high-quality conference, paging and PA applications. A filter in the microphone grille shall suppress wind and pop noise. The LED ring integrated in the microphone head shall have an external supply. The microphone shall have an excellent RFI shielding and is immune to wireless communication devices. The conference microphone shall operate without preamp with a power of 5 V. The gooseneck shall have two flexible 6 mm [0.24"] thin elements with a rigid tube in between. The housing shall be black, free from reflections and completely made of metal. The microphone head shall have a diameter of 13.6 mm [0.54"]. The total length from the connector to the microphone shall be 516 mm [20.31"]. The frequency response shall be 50 to 19,000 Hz. The open circuit voltage shall be 17 mV/Pa. The nominal impedance shall be 200 ohms. The microphone shall be provided with a 5-pin XLR connector (male). The net weight shall be 0.132 kg [0.29 lbs].

Manufacturer: beyerdynamic
Type: Classis GM 315 E