

Install Speakers

DUBLIN TCX152-R-WH

2 Way 15" Loudspeaker for Installation
Applications (Weather Resistant, White)

- 2 way loudspeaker for portable PA and fixed installation applications
- 350 Watts continuous, 1,400 Watts peak power
- All components weather resistant to IP54 for outdoor use
- High excursion 15" low frequency driver with low mass voice coil for improved transient response
- 1" high temperature dome compression driver with extended high frequency reproduction
- Rotatable converging elliptical waveguide provides 90° H x 60° V dispersion
- M10, M8 and M6 rigging points compatible with TURBOSOUND and OmniMount* brackets
- Trapezoidal cabinet shape enables visually unobtrusive loudspeaker arrays
- 15 mm (5/8") birch plywood enclosure with hard wearing semi matt white paint finish
- Powder coated perforated plated steel mesh grille with foam backing
- Captive cable tail with sealed cable gland on aluminium connector panel
- 3-Year Warranty Program*
- Designed and engineered in England

The DUBLIN TCX152-R-WH is a 1,400 Watt compact 15" passive two way loudspeaker that is ideally suited for a wide range of portable or installed speech and music sound reinforcement applications. TCX152-R-WH consists of a trapezoidal enclosure housing a high excursion 15" reflex-loaded low frequency driver with low mass voice coil for improved transient response, and a 1" high temperature dome compression driver mounted on a rotatable converging elliptical waveguide, which provides a 90° horizontal by 60° vertical dispersion pattern.



Custom-Engineered Drivers

TURBOSOUND is recognised the world over for designing and building some of the most iconic loudspeakers and subwoofers. We take meticulous care and pride in maintaining that reputation by utilising only drivers designed specifically for each application – it's what sets us apart from the competition – it's what sets us apart from the competition. TCX152-R-WH's high excursion 15" low frequency and 1" high temperature dome compression drivers ensure truly world-class performance that will stand the test of time.

*All third-party trademarks are the property of their respective owners. Their use neither constitutes a claim of the trademark nor affiliation of the trademark owners with MUSIC Group. Product names are mentioned solely as a reference for compatibility, effects and/or components. Warranty details can be found at music-group.com.

Install Speakers

DUBLIN TCX152-R-WH

2 Way 15" Loudspeaker for Installation
Applications (Weather Resistant, White)

Rotatable Waveguide

The TCX152-R-WH's compression driver is mated to a converging elliptical waveguide that is rotatable through 90°, allowing a swap of the horizontal and vertical dispersion patterns for a smooth wavefront, while providing exceptional pattern control. This feature is especially useful for retaining wide horizontal dispersion when the enclosure is mounted horizontally due to ceiling height restrictions.



Construction and Connectivity

Constructed from 15 mm (5/8") birch plywood, the cabinet is finished in hard wearing semi matt white textured paint and includes internal M10, M8 and M6 threaded rigging points for use with [TURBOSOUND](#) wall and ceiling brackets, and industry standard loudspeaker brackets. A perforated steel mesh grille backed with reticulated foam protects the drive units. The rear panel features a sealed captive cable and gland.

Designed to Weather the Elements

When permanently installed, the TCX152-R-WH presents a discreet appearance with no visible side handles for visually unobtrusive loudspeaker arrays. The weatherised paint, zinc plated grill with outdoor powdercoat, and weather resistant coated drivers deliver an IP54 rated package that not only provides class-leading performance, but maintains its attractive appearance for many years.



Install Speakers

DUBLIN TCX152-R-WH

2 Way 15" Loudspeaker for Installation
Applications (Weather Resistant, White)



You Are Covered

We always strive to provide the best possible Customer Experience. Our products are made in our own [MUSIC Group](#) factory using state-of-the-art automation, enhanced production workflows and quality assurance labs with the most sophisticated test equipment available in the world. As a result, we have one of the lowest product failure rates in the industry, and we confidently back it up with a generous [3-Year Warranty program](#).

Install Speakers

DUBLIN

TCX152-R-WH

2 Way 15" Loudspeaker for Installation
Applications (Weather Resistant, White)

Frequency Response Sensitivity 1 W / 1 m

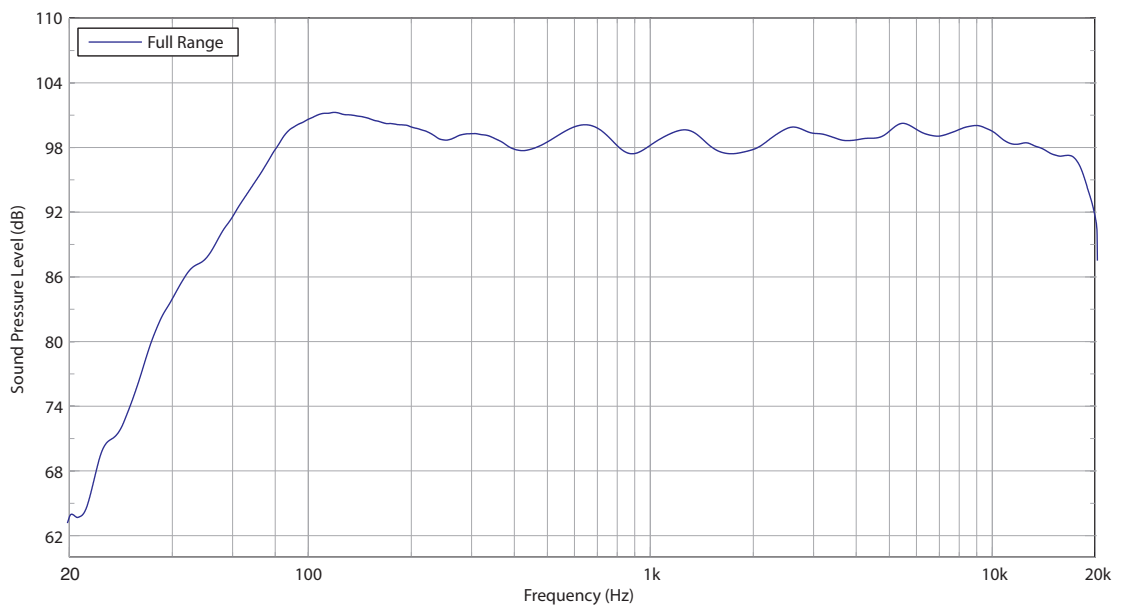

Impedance

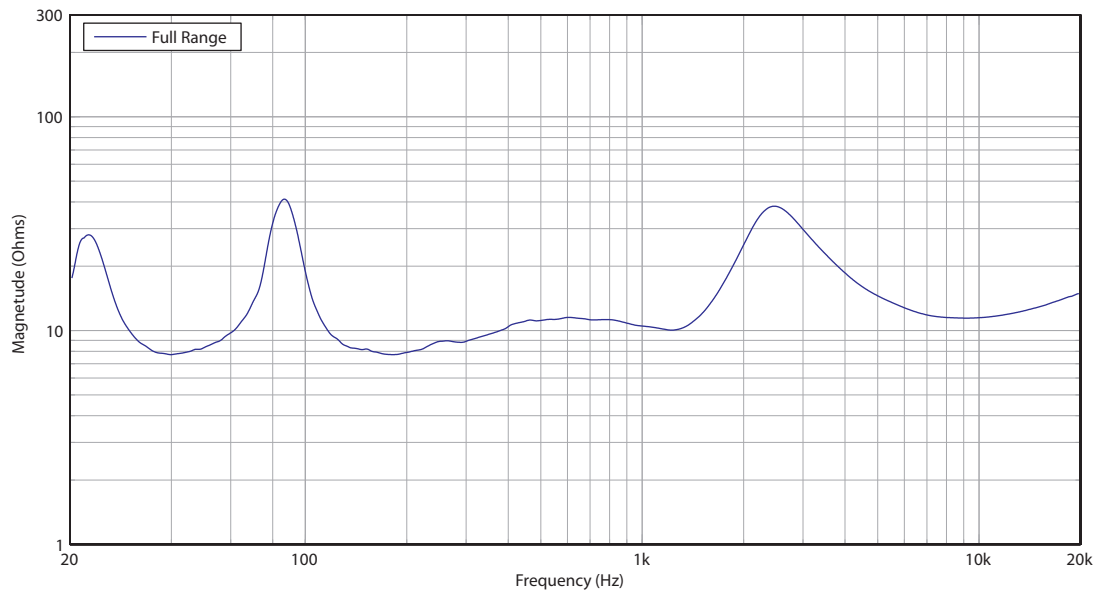

Install Speakers

DUBLIN

TCX152-R-WH

2 Way 15" Loudspeaker for Installation
Applications (Weather Resistant, White)

Horizontal Beamwidth

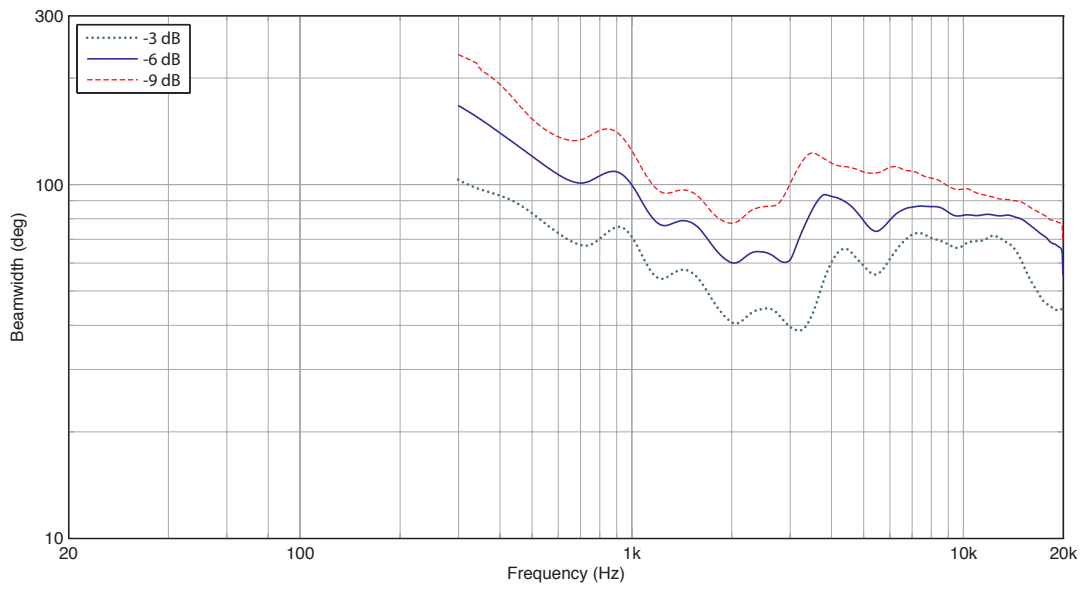

Vertical Beamwidth

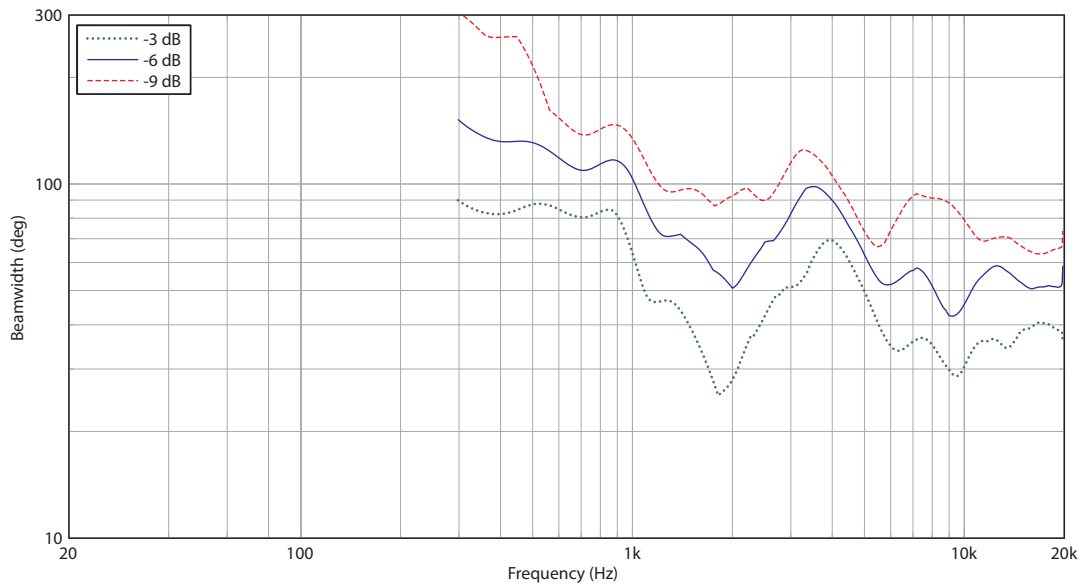

Install Speakers

DUBLIN

TCX152-R-WH

2 Way 15" Loudspeaker for Installation
Applications (Weather Resistant, White)

Horizontal Polar Plots

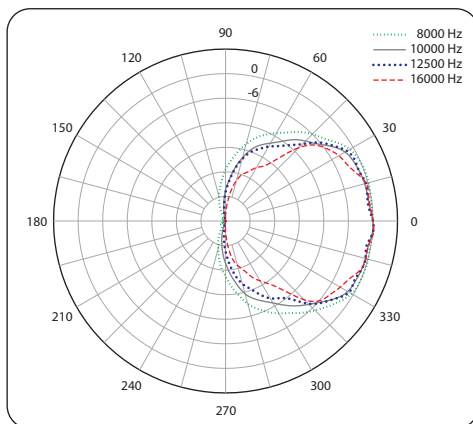
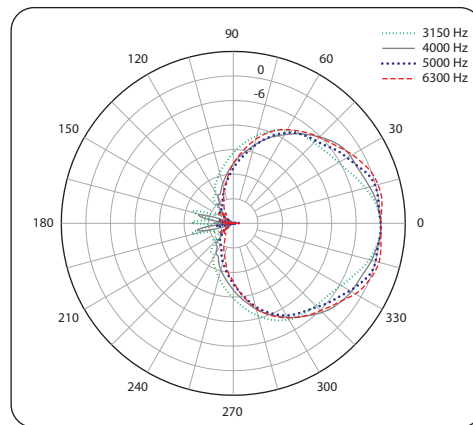
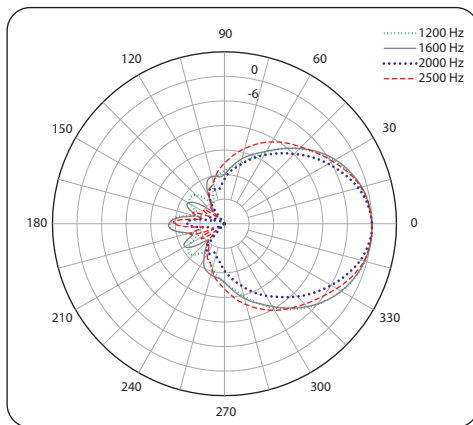
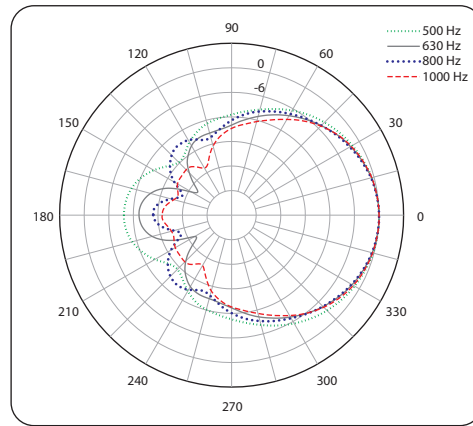
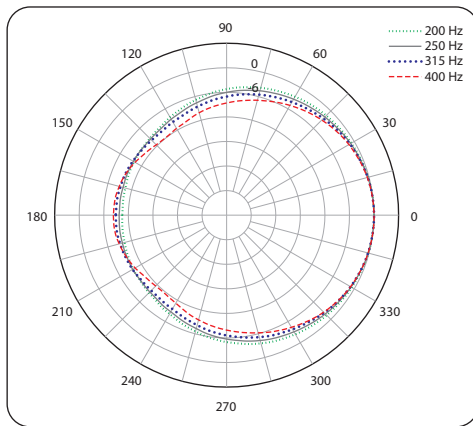

Install Speakers

DUBLIN

TCX152-R-WH

2 Way 15" Loudspeaker for Installation
Applications (Weather Resistant, White)

Vertical Polar Plots

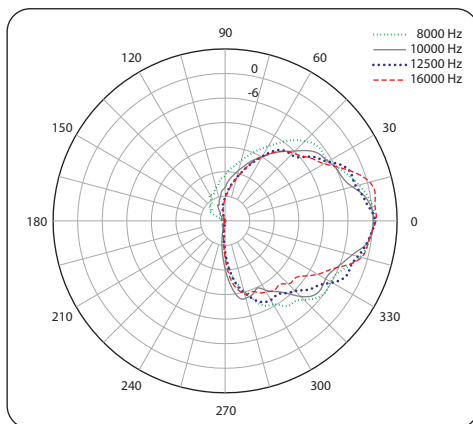
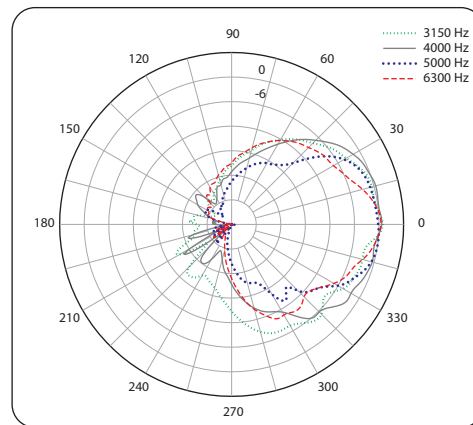
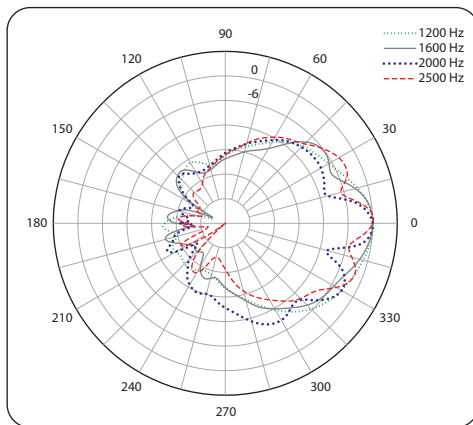
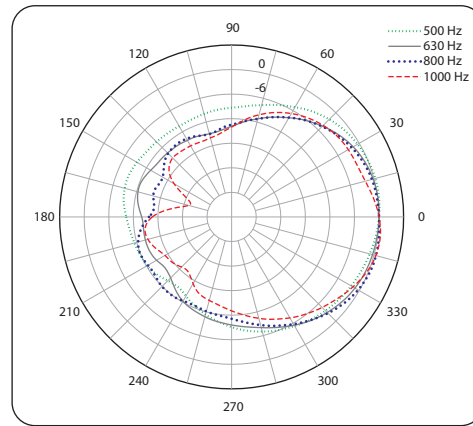
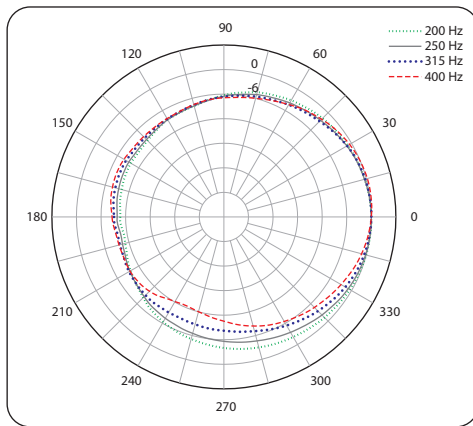

Install Speakers

DUBLIN

TCX152-R-WH

2 Way 15" Loudspeaker for Installation
Applications (Weather Resistant, White)

Dimensions

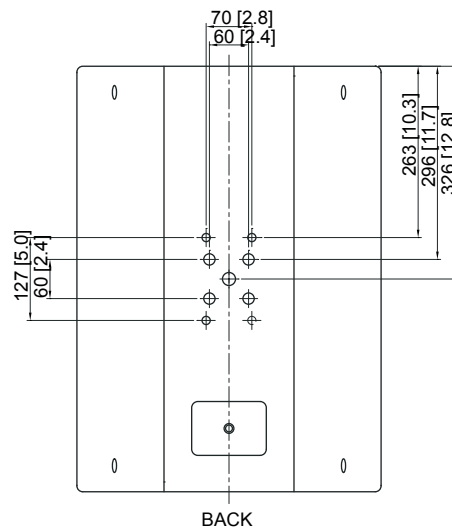
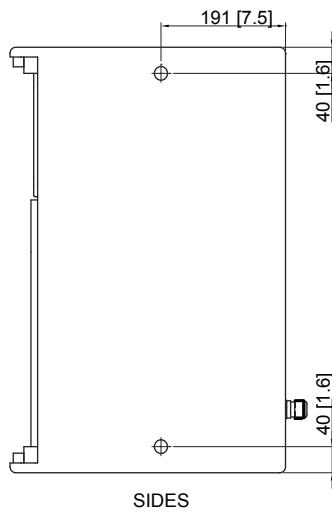
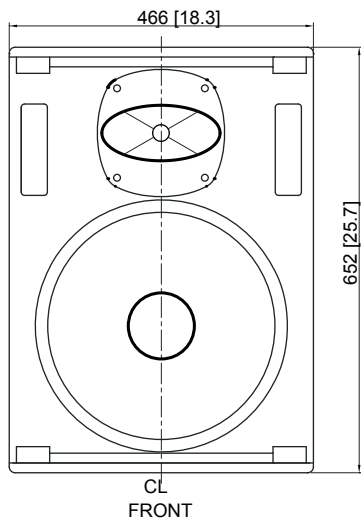
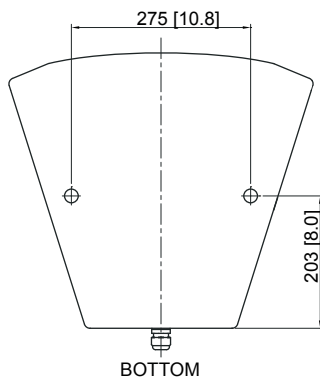
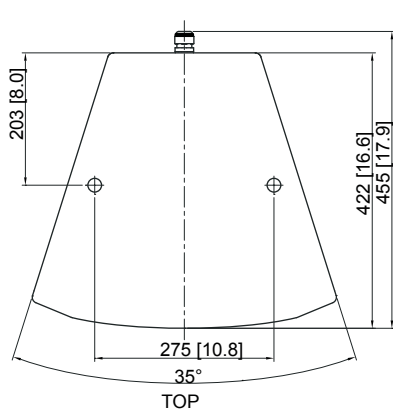

Install Speakers

DUBLIN TCX152-R-WH

2 Way 15" Loudspeaker for Installation
Applications (Weather Resistant, White)

Mounting and Rigging

The cabinet is fitted with M6 x 4, M8 x 4 and M10 x 9 internally-threaded rigging points that allow it to be rigged with optional shoulder eyebolts and mounted in many different configurations in permanent installations. The simplest method of rigging is to use two rigging points on the top, and a single pull-back rigging point on the rear panel. Adjustment of the length of the rear cable allows the cabinet to be angled for optimum room coverage. Cabinets may also be hung upside down if required. The horn of each cabinet may be rotated through 90 degrees to optimise the coverage.

The cabinet is compatible with industry standard wall and ceiling brackets.

Install Speakers

DUBLIN

TCX152-R-WH

2 Way 15" Loudspeaker for Installation
Applications (Weather Resistant, White)

Technical Specifications

System

Frequency response	85 Hz - 18 kHz \pm 3 dB 55 Hz - 20 kHz -10 dB
Nominal dispersion	90° H x 60° V @ -6 dB points
Power handling (IEC)	350 W continuous, 1,400 W peak
Sensitivity	99 dB (1 W @ 1 m)
Maximum SPL	125 dB continuous, 131 dB peak
Impedance	8 Ω
Components	1 x 15" (381 mm) LF driver 1 x 1" (25 mm) HF compression driver

Enclosure

Connectors	2-core captive cable tail
Wiring	Pins 1+ / 1- input, pins 2+ / 2- link
Dimensions HWD	652 x 466 x 422 mm (25.7 x 18.3 x 16.6")
Net weight	23.5 kg (51.8 lbs)
Construction	15 mm (5/8") birch plywood
Finish	Semi matt white paint
Grille	Powder coated perforated Zinc plated steel
Flying hardware	M10 x 9, M8 x 4, M6 x 4 Points

Install Speakers

DUBLIN TCX152-R-WH

2 Way 15" Loudspeaker for Installation
Applications (Weather Resistant, White)

Architecture & Engineering Specifications

The loudspeaker shall be of the full range, two-way passive type consisting of one 15" (381 mm) LF driver and one 1" (25 mm) HF compression driver. The loudspeaker shall be weather resistant for outdoor use, to rating standard IP54. Performance specifications of a typical production unit shall meet or exceed the following: frequency response, measured with swept sine wave input, shall be flat within ± 3 dB from 85 Hz to 18 kHz and within -10 dB from 55 Hz to 20 kHz. Nominal dispersion, at -6 dB points, shall average 90° H x 60° V, rotatable. Nominal impedance shall be 8 Ohms. Power handling shall be 350 Watts continuous, 1,400 Watts peak. Sensitivity, measured on axis, mean averaged over stated bandwidth, shall be 99 dB, 1 Watt @ 1 metre. Maximum SPL (peak), measured at 1 metre with music program at stated amplifier input, shall be 131 dB. Dimensions: 652 mm high x 466 mm wide x 422 mm deep (25.7" x 18.3" x 16.6"). Net weight: 23.5 kg (51.8 lbs). The loudspeaker system shall be the **TURBOSOUND** TCX152-R-WH. No other loudspeaker shall be acceptable unless submitted data from an independent test laboratory verifies that the above combined performance / size specifications are equalled or exceeded.

Install Speakers

DUBLIN

TCX152-R-WH

2 Way 15" Loudspeaker for Installation
Applications (Weather Resistant, White)



Install Speakers

DUBLIN TCX152-R-WH

2 Way 15" Loudspeaker for Installation
Applications (Weather Resistant, White)

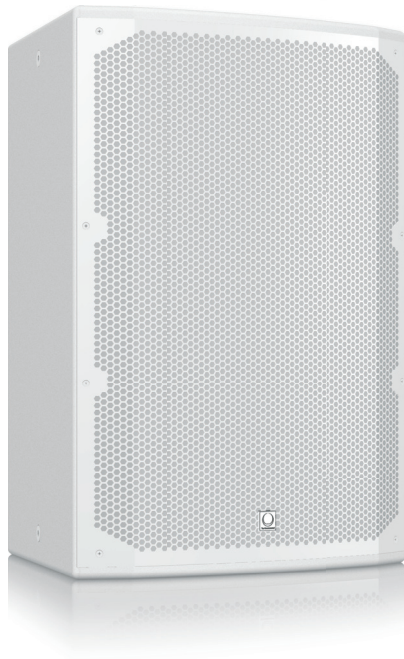
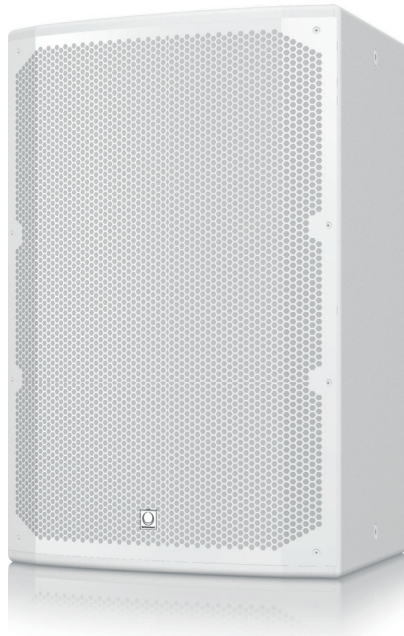

Install Speakers

DUBLIN TCX152-R-WH

2 Way 15" Loudspeaker for Installation
Applications (Weather Resistant, White)



For service, support or more information contact the TURBOSOUND location nearest you:

Europe
MUSIC Group Services UK
Tel: +44 156 273 2290
Email: CARE@music-group.com

USA/Canada
MUSIC Group Services NV Inc.
Tel: +1 702 800 8290
Email: CARE@music-group.com

Japan
MUSIC Group Services JP K.K.
Tel: +81 3 6231 0454
Email: CARE@music-group.com

MUSIC Group accepts no liability for any loss which may be suffered by any person who relies either wholly or in part upon any description, photograph, or statement contained herein. Technical specifications, appearances and other information are subject to change without notice. All trademarks are the property of their respective owners. MIDAS, KLARK TEKNIK, LAB GRUPPEN, LAKE, TANNÖY, TURBOSOUND, TC ELECTRONIC, TC HELICON, BEHRINGER, BUGERA and DDA are trademarks or registered trademarks of MUSIC Group IP Ltd.
© MUSIC Group IP Ltd. 2016 All rights reserved.