

PHONIC

PHONIC AM844D USB
 6-CHANNEL 48-VOLTAGE MIXER WITH HIGH-RESOLUTION DIGITAL EFFECT

PROGRAM LIST:
 1. SMALL HALL
 2. MID ROOM
 3. PLATE
 4. CATHEDRAL
 5. JAZZ LOUNGE
 6. PING PONG DELAY
 7. SHORT DELAY
 8. VOCAL PLATE
 9. CONCERT HALL
 10. STAGE
 11. ECHO
 12. CHORUS
 13. CHORUS + REV
 14. SPRING

www.PHONIC.COM

AM844D USB

- User's Manual
- Manual del Usuario

AM844D USB

COMPACT MIXERS
MEZCLADORAS COMPACTAS



ENGLISH	I
ESPAÑOL	II
APPENDIX	III

USER'S MANUAL

CONTENTS

INTRODUCTION.....	1
FEATURES.....	1
SYSTEM REQUIREMENTS.....	1
BASIC SETUP.....	1
MAKING CONNECTIONS.....	2
CONTROLS AND SETTINGS.....	4
SPECIFICATIONS.....	8

APPENDIX

DIGITAL EFFECT TABLE.....	1
APPLICATION.....	2
DIMENSION.....	3
BLOCK DIAGRAM.....	4

Phonic preserves the right to improve or alter any information within this document without prior notice.

IMPORTANT SAFETY INSTRUCTIONS

The apparatus shall not be exposed to dripping or splashing and that no objects filled with liquids, such as vases, shall be placed on the apparatus. The MAINS plug is used as the disconnect device, the disconnect device shall remain readily operable.

Warning: the user shall not place this apparatus in the confined area during the operation so that the mains switch can be easily accessible.

1. Read these instructions before operating this apparatus.
2. Keep these instructions for future reference.
3. Heed all warnings to ensure safe operation.
4. Follow all instructions provided in this document.
5. Do not use this apparatus near water or in locations where condensation may occur.
6. Clean only with dry cloth. Do not use aerosol or liquid cleaners. Unplug this apparatus before cleaning.
7. Do not block any of the ventilation openings. Install in accordance with the manufacturer's instructions.
8. Do not install near any heat sources such as radiators, heat registers, stoves, or other apparatus (including amplifiers) that produce heat.
9. Do not defeat the safety purpose of the polarized or grounding-type plug. A polarized plug has two blades with one wider than the other. A grounding type plug has two blades and a third grounding prong. The wide blade or the third prong is provided for your safety. If the provided plug does not fit into your outlet, consult an electrician for replacement of the obsolete outlet.
10. Protect the power cord from being walked on or pinched particularly at plug, convenience receptacles, and the point where they exit from the apparatus.
11. Only use attachments/accessories specified by the manufacturer.
12. Use only with a cart, stand, tripod, bracket, or table specified by the manufacturer, or sold with the apparatus. When a cart is used, use caution when moving the cart/apparatus combination to avoid injury from tip-over.
13. Unplug this apparatus during lightning storms or when unused for long periods of time.
14. Refer all servicing to qualified service personnel. Servicing is required when the apparatus has been damaged in any way, such as power-supply cord or plug is damaged, liquid has been spilled or objects have fallen into the apparatus, the apparatus has been exposed to rain or moisture, does not operate normally, or has been dropped.

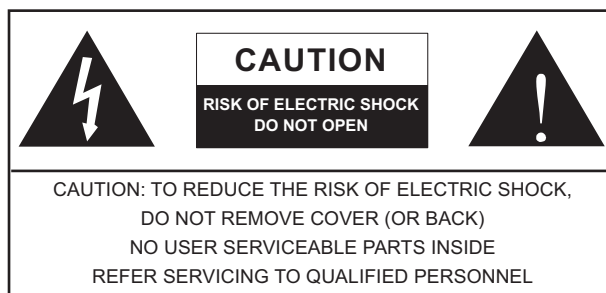

The lightning flash with arrowhead symbol, within an equilateral triangle, is intended to alert the user to the presence of uninsulated "dangerous voltage" within the product's enclosure that may be of sufficient magnitude to constitute a risk of electric shock to persons.



The exclamation point within an equilateral triangle is intended to alert the user to the presence of important operating and maintenance (servicing) instructions in the literature accompanying the appliance.

WARNING: To reduce the risk of fire or electric shock, do not expose this apparatus to rain or moisture.

CAUTION: Use of controls or adjustments or performance of procedures other than those specified may result in hazardous radiation exposure.



INTRODUCTION

Congratulations on choosing one of Phonic's many quality compact mixers. The AM844D USB compact mixer – designed by the talented engineers that, in the past, have created a variety of mixers fantastic in style and performance – displays similar proficiency that previous products have shown; with more than a few refinements, of course. The entire AM series features full gain ranges, amazingly low distortion levels, and incredibly wide dynamic ranges – just showing the dominance these small machines will have in any venue. The AM844D USB also offers a USB interface for making stereo recordings on any modern Windows- or Mac-based computer.

We know how eager you are to get started – wanting to get the mixer out and hook it all up is probably your number one priority right now – but before you do, we strongly urge you to take the time to look through this manual. Inside you will find important facts and figures on the setup, use and application of your brand new mixer. If you do happen to be one of the many people who flatly refuse to read user manuals, then we just urge you to at least glance at the Basic Setup section. After glancing at or reading through the manual (we applaud you if you do read the entire manual), please store it in a place that is easy for you to find, because chances are there is something you missed the first time around.

FEATURES

- Stereo USB interface for PC or Mac recording
- 8 Mic/Line mono channels with direct outs, 3-band EQ and adjustable compressor
- 4 stereo channels (two with microphone inputs)
- 8 direct outputs for multi-track recording
- 3-band EQ with swept-mid range plus low cut on each mono channel
- 18dB/oct, 75Hz Loc Cut Filter on each mic channels
- Four AUX sends, AUX 1 & 2 with Pre/Post selector
- 32/40-bit digital stereo effect processor with 16 programs
- 4 stereo AUX Returns
- Solo selector on each input channel
- CTRL RM Phones with multi input source matrix selector
- 8 subgroups with fader control and L-R assign buttons
- 2T/USB return with level control and TO MAIN L/R assign button
- Built-in switching power supply with universal connector, 100-240VAC, 50/60Hz
- 12V BNC connector for gooseneck lamp
- Solo switch pre/post selector for AUX Returns

SYSTEM REQUIREMENTS

Windows

- Windows™ XP SP2, Vista™ or 7
- Intel™ Pentium™ 4 processor or better
- 512 MB RAM (1 GB recommended)

Macintosh

- Apple™ Mac™ OSX 10.5 or higher
- G4™ processor or better
- 512 MB RAM (1 GB recommended)

BASIC SETUP

Getting Started

1. Ensure all power is turned off on the AM844D USB mixer. To totally ensure this, the AC cable should not be connected to the unit.
2. All faders and level controls should be set at the lowest level and all channels switched off to ensure no sound is inadvertently sent through the outputs when the device is switched on. All levels should be altered to acceptable degrees after the device is turned on.
3. Plug all necessary instruments and equipment into the device's various inputs as required. This may include line signal devices, as well as microphones and/or guitars, keyboards, etc.
4. Plug any necessary equipment into the device's various outputs. This could include amplifiers, active speakers or monitors, signal processors, and/or recording devices.
5. Plug the supplied AC cable into the AC inlet on the back of the device ensuring the local voltage level is identical to that required on your device.
6. Plug the supplied AC cable into a power outlet of a suitable voltage.
7. Turn the power switch on.

Channel Setup

1. To ensure the correct audio levels of each input channel is selected, every channel should first be switched off and all faders set to U.
2. Choose the channel that you wish to set the level of, and ensure that channel has a signal sent to it similar to the signal that will be sent when in common use. For example, if the channel is using a microphone, then you should speak or sing at the same level the performer normally would during a performance. If a guitar is plugged into that channel, then the guitar should also be used as it normally would be.
3. Press the Solo button of the channel, and ensure the Pre / Post button is pushed-in, allowing you to see the audio level in the master level meter.
4. Set the gain of the selected channel to a level that ensures the audio level is around 0 dB, as indicated by the level meter.
5. This channel is now ready to be used; you can stop making the audio signal.
6. To activate the channel, release the Solo button and engage the channel's 'ON' button and press the 1-2, 3-4 or L-R routing buttons, allowing the signal to be sent to the corresponding destinations.
7. You should now select the next channel to set and go back to follow steps 1 through 6.

Computer Connection

By simply connecting the USB cable provided along with your AM844D USB to the device and your Personal Computer or Laptop, you are able to send CD quality (16-bit stereo, with a 44.1 kHz sampling rate) signal to and from your mixer. By doing this, you are actually turning your AM844D USB into a highly useful plug'n'play soundcard for your computer.

The USB sends an audio stream of the Main Left and Right (record out) signal of your mixer to the computer. You can use almost any dedicated Digital Audio Workstation (DAW) software to record the signal from the AM mixer. You can also set the mixer as your default audio device.

The USB interface also returns the audio signal from your computer back to the 2T Returns, the signal of which is controlled by the 2T / USB Return control. If there are input signals from both the USB interface and the 2T Return, the two signals are combined and controlled simultaneously by the 2T return control.

Windows

1. Turn both the AM844D USB and the computer on.
2. Connect the AM mixer to the computer via the provided USB cable.
3. Let Windows find the device and install an appropriate driver.
4. Enter the Control Panel and select Sounds and Audio Devices.
5. When here, go to the Audio tab and select the "USB Audio Codec" as your default sound recording and playback device.
6. Depending whether you have Windows XP, Vista, 7 or 8, this may differ slightly but the setting can always be found within the Control Panel's audio menu.
7. If you don't want to use the AM844D USB as your default audio device, you can simply enter your DAW or other audio program and select it as your default device in the program only.
8. Be sure to set your minimum buffer settings to 64 samples as to avoid clicks and pops.

Mac

1. Turn both the AM844D USB and the computer on.
2. Connect the AM mixer to the computer via the provided USB cable.
3. Enter the AUDIO MIDI SETUP menu.
4. Select the "USB Audio Codec" as your input and output device.
5. The AM844D USB is now your default audio device.
6. Alternatively, enter your DAW software (or other relevant audio program) and select the "USB Audio Codec" in the device preferences.
7. Be sure to set your minimum buffer settings to 64 samples as to avoid clicks and pops.

MAKING CONNECTIONS

Channel Inputs

1. XLR Jacks

These jacks accept XLR inputs for balanced signals. They can be used in conjunction with microphones – such as professional condenser, dynamic or ribbon microphones – with standard XLR male connectors. With low noise preamplifiers, these inputs serve for crystal clear sound replication.

NB. When using an unbalanced microphone, please ensure phantom power is switched off. However, when using condenser microphones the phantom power should be activated.

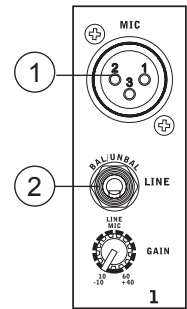

2. Line In Jacks

These inputs accept 1/4" TRS and 1/4" TS line inputs for the addition of various music instruments – such as keyboards, drum machines, electric guitars, as well as a variety of other electric instruments.

3. Stereo Channel Inputs

The AM844D USB features 4 stereo input channels (channels 9 through to 16), the inputs of which differ slightly to the mono channels. The 3-pin XLR inputs on the first two stereo inputs are for the addition of microphones with typical XLR male inputs, where the Line 1/4" TRS jacks can be used for various stereo line level input devices, such as keyboards. If you wish to use a mono device on a stereo return input, simply plug the device's 1/4" phone jack into the left (mono) stereo input and leave the right input bare. The signal will be duplicated to the right due to the miracle of jack normalizing.

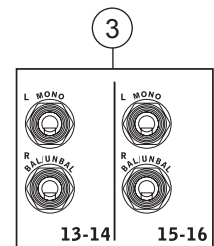

Master Section

4. 2T Return

The first of these inputs accommodates RCA cables from such devices as tape and CD players. These can accommodate CD players, MP3 players (such as the Apple iPod), as well as laptop computers. This may require a y-cord with 1/8" mini stereo jack on one end, and RCA connectors on the other.

5. Record Outputs

As with the Tape In ports, these outputs will accommodate RCA cables, able to be fed to a variety of recording devices.

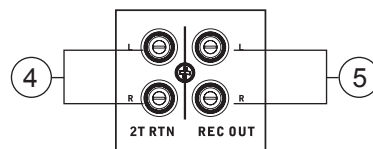

6. Phones Outputs

These stereo output ports are suited for use with headphones, allowing monitoring of the mix. The audio level of this output is controlled using the Control Room/Phones control on the front panel's master section.

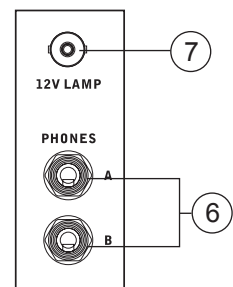

7. 12V Lamp

This BNC socket allows you to attach a 12 Volt gooseneck lamp, allowing better visibility in areas with poor light.

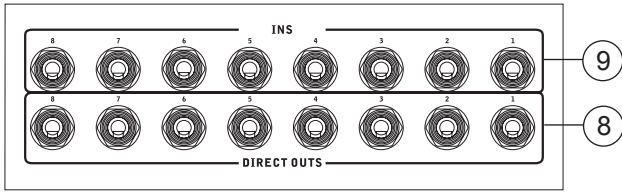

Rear Panel

8. Direct Outs

These connections are for the direct output of the signals received by mono channels 1 through to 8, post-fader, post-EQ, post-HPF, post-mute. They are most commonly used to connect Multi-track recorders, allowing the AM844D USB to be used as an 8-track studio mixer.

9. Insert Jacks

The primary use for these TRS phone jacks is for the addition of external devices, such as dynamic processors or equalizers, to the corresponding mono input channel. This will require a Y cord that can send and receive signals of the mixer to and from an external processor.

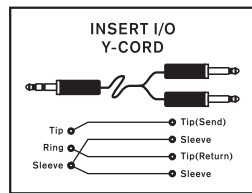

10. Auxiliary (AUX) Sends

These 1/4" phone jacks are the final output of line-level signal fed from the corresponding auxiliary send mixes, and are best suited for use with stage monitors. Feeding the output from the Auxiliary outs to an amplifier - and possibly an equalizer - and then to a floor monitor speaker allows artists to monitor their own instruments or vocals whilst performing.

11. Main Outputs

These outputs will output the final stereo line level signal sent from the main mix. The primary purpose of the two XLR jacks is to send the main output to external devices, which may include power amplifiers (and in-turn, a pair of speakers), other mixers, as well as a wide range of other possible signal processors (equalizers, crossovers, etcetera). The two 1/4" phone jacks are able to send the Main output to external devices that may run in parallel with the mixer. This may include additional power amplifiers, mixers, PA systems, as well as a wide range of other possible signal processors.

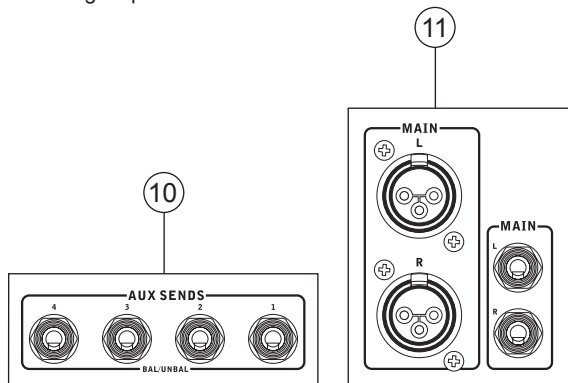

12. Main Insert

Located on the rear of the AM844D USB, the primary use for these TRS phone jacks is for the addition of external devices, such as dynamic processors or equalizers, to the main L and main R signals. This will require a Y-cable that can send (pre-fader) and receive signals to and from an external processor.

13. Control Room Outputs

These two 1/4" phone jack outputs feed the signal altered by the Control Room level control on the face of the mixer. This output has extensive use, as it can be used to feed the signal from the mixer to an active monitor, for the monitoring of the audio signal from within a booth, among many other possible uses.

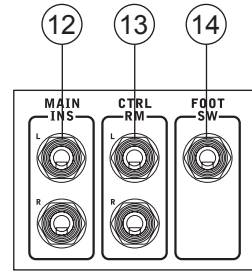

14. Foot Switch Jack

These ports are for the inclusion of a foot switch, used to remotely change the built-in digital effect processor between on and off.

15. Group Outs

These 1/4" phone jacks output the final feed from the Group 1/5, 2/6, 3/7 and 4/8 Faders on the main panel of the mixer. These outputs can be used to feed multi-track records, as well as an amplifier and speakers to be used along with the Main Speakers.

NB. When sending unbalanced signals from this output, a 1/4" TRS stereo plugs must be used and have the ring-pin disconnected, as to avoid damaging this mixer.

16. AUX Returns

The 1/4" TRS AUX Return inputs are for the return of audio to the AM844D USB mixer, processed by an external signal processor. If really needed, they can also be used as additional inputs. The feed from these inputs can be adjusted using the AUX Return controls on the face of the mixer. When connecting a monaural device to the AUX Return 1, 2 and 4 inputs, simply plug a 1/4" phone jack into the left (mono) input, and the signal will appear in the right as well. This, however, does not work for the AUX Return 3.

NB. When any device is plugged into the mixer's corresponding EFX Return inputs (AUX Return 3), the mixer's internal digital effect engine is then disabled.

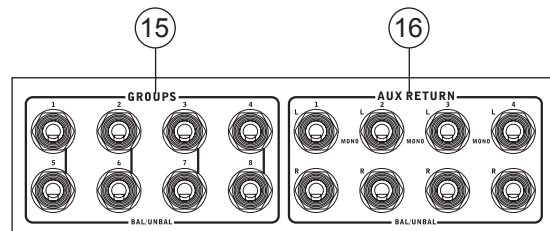

17. USB Port

This USB connector can be used to connect the AM844D USB to any modern Windows or Mac-based computer. Doing so will allow users to get a stereo signal both to and from the computer.

18. Power Connector and Fuse Holder

This port is for the addition of a power cable and supply, allowing power to be supplied to the mixer. Please use the power cable that is included with this mixer only. The fuse holder (located above the AC Power connector) is for the AM844D USB's fuse. If the fuse happens to blow, open the holder cover, and replace the fuse with a suitable replacement (as indicated below the power connector).

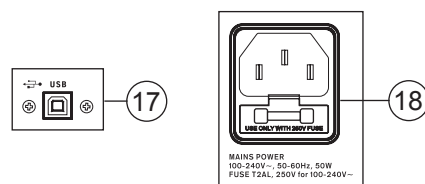

CONTROLS AND SETTINGS

Rear Panel

19. Power Switch

This switch is used to turn the mixer on and off. Ensure you turn all level controls down before activating.

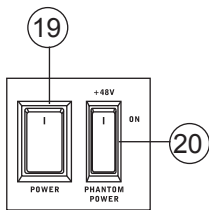

20. Phantom Power Switch

When this switch is in the on position, it activates +48V of phantom power for all microphone inputs, allowing condenser microphones (well, the ones that don't use batteries) to be used on these channels. Activating Phantom Power will be accompanied by an illuminated LED above the left channel Level Meter. Before turning Phantom Power on, turn all level controls to a minimum to avoid the possibility of a ghostly popping sound from the speakers.

NB. Phantom Power should be used in conjunction with balanced microphones. When Phantom Power is engaged, single ended (unbalanced) microphones and instruments should not be used on the Mic inputs. Phantom Power will not cause damage to most dynamic microphones, however if unsure, the microphone's user manual should be consulted.

Channel Controls

21. Compressor Control and Indicator

This controls the onboard compressor function on mono channels. Turning this control up towards the 12 o'clock position will adjust the threshold and ratio of the compressor at varying degrees. Once you reach the 12 o'clock position, the control will then adjust the compression settings along with an onboard expander (or, in other words, a compander). The LED that accompanies this control will light up when the compressor is triggered.

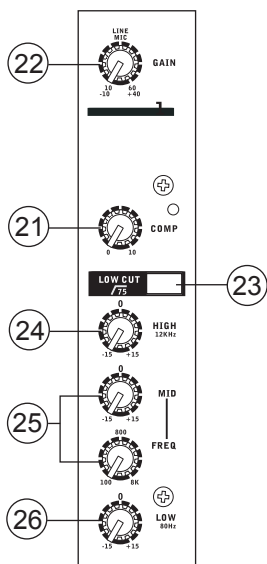

22. Gain Control

This controls the sensitivity of the input signal of the Line/Microphone input of mono channels, and the Microphone input only of stereo input channels. The gain should be adjusted to a level that allows the maximum use of the audio, while still maintaining the quality of the feed. This can be accomplished by adjusting it to a level that will allow the peak indicator occasionally illuminate.

23. Low Cut Filter (75 Hz)

This button, located on channels 1 through to 12, will activate a high-pass filter that reduces all frequencies below 75 Hz at 18 dB per Octave, helping to remove any unwanted ground noise or stage rumble. On stereo channels 9-10 and 11-12, the low cut filter affects only the XLR Microphone inputs (and not the line inputs).

24. High Frequency Control

This control is used to give a shelving boost or cut of ± 15 dB to high frequency (12 kHz) sounds. This will adjust the amount of treble included in the audio of the channel, adding strength and crispness to sounds such as guitars, cymbals, and synthesizers.

25. Middle Frequency Control

This control is used to provide a peaking style of boost and cut to the level of middle frequency sounds at a range of ± 15 dB. The AM844D USB mixer also provides a sweep control, allowing you to select a center frequency between 100 Hz and 8 kHz. Changing middle frequencies of an audio feed can be rather difficult when used in a professional audio mix, as it is usually more desirable to cut middle frequency sounds rather than boost them, soothing overly harsh vocal and instrument sounds in the audio.

The stereo channels of the AM844D USB mixer feature a High-Mid and Low-Mid control instead of the typical controls described above. They provide a peaking style of boost and cut to middle frequencies, where the frequencies are set at 3 kHz and 800 Hz for the High- and Low-Mids respectively.

26. Low Frequency Control

This control is used to give a shelving boost or cut of ± 15 dB to low frequency (80 Hz) sounds. This will adjust the amount of bass included in the audio of the channel, and bring more warmth and punch to drums and bass guitars.

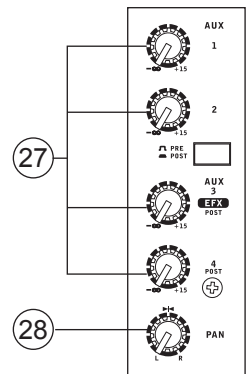

27. AUX Controls

These four AUX controls alters the signal level that is being sent to the aux 1 to 4 mixes, the signal of which is suitable for connecting stage monitors, allowing artists to listen to the music that is being played. AUX 1 and 2 feature a Pre/Post button, which alternates the feed to the AUX mix between a post and pre-fader feed. AUX 3, on the other hand, acts as an EFX send, the signal of which can be used in conjunction with external signal processors (which can be returned to the mixer via the AUX return input), or simply as an Auxiliary output. Both the AUX 3 (EFX) and AUX 4 controls are post fader and are sent directly to the corresponding outputs.

28. Pan / Balance Controls

This alternates the degree or level of audio that the left and right side of the main mix should receive. On mono channels, the PAN control will adjust the level that the left and right should receive (pan), where as on a stereo channel, adjusting the BAL control will attenuate the left or right audio signals accordingly (balance).

29. On Button and Indicator

This turns the channel on, allowing the user to use the feed from the channel's inputs to supply the MAIN L/R, GROUP 1/2, GROUP 3/4, AUX and EFX buses (as specified by the user, of course). The corresponding indicator will be illuminated when turned on.

30. 1-2, 3-4 and L-R Buttons

These handy buttons allow you to decide the audio path of the corresponding channel. Pushing the "1/2" or "3/4" buttons allows the signal to be sent to the Group 1/2 or 3/4 mixes respectively, where the "L-R" allows it to be sent to the Main L/R mix.

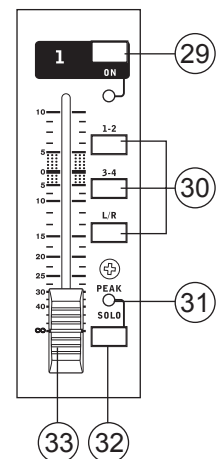

31. Peak Indicator

This LED indicator will illuminate when the channel hits high peaks, 6 dB before overload occurs. It is best to adjust the channel level control so as to allow the PEAK indicator to light up on regular intervals only. This will ensure a greater dynamic range of audio. This indicator also doubles as a Solo indicator, when the SOLO button is engaged.

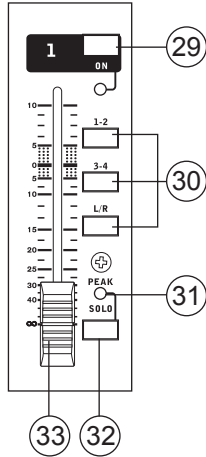

32. Solo Button

The Solo button is pushed to allow the signal of the corresponding channel to be sent to the Control Room / Phones mixing bus (pre or post fader, depending on the properties selected by the pre / post button, located by the Control Room / Phones source buttons), for use with either headphones or studio monitors.

This button also allows for easier isolation of individual channel signals, ensuring setting of the input gain or tracking of audio by sound engineers is made simpler. The Peak indicator above the Solo button also doubles as a Solo Indicator, illuminating whenever the Solo function is activated.

33. Channel Level Control (Fader)

This control will alter the signal level that is sent from the corresponding channel to the corresponding mixing buses.

Digital Effect Engine

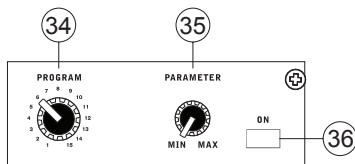

34. Program Control

This rotary control allows users to select the digital effect program of your choice. There are 16 points on the rotary control, each of which corresponds with an effect type. See the digital effect table for more information.

35. Parameter Control

Turning this control will adjust the one main parameter of the selected effect. Each effect's parameter can be found on the digital effect table.

36. Effect On Button

This button is pushed to turn the corresponding effect panel on or off. Effects can also be disabled by using a footswitch with the jack on the rear of the mixer. Please note: this button will not lock down as similar buttons on the mixer do.

Master Section

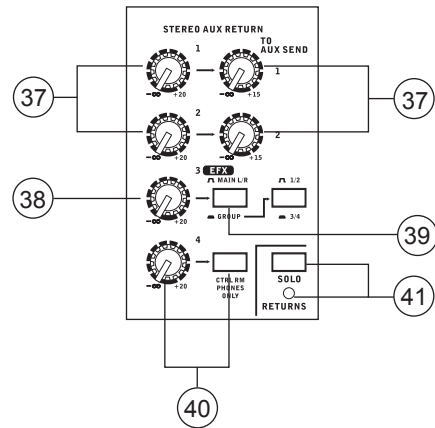

37. AUX Return 1 and 2 Controls

These controls adjust the signal level of audio fed through to the stereo AUX Return inputs. The "To AUX Send 1" and "To AUX Send 2" controls adjust the pre-fader level of the signal from the AUX Return controls to the corresponding AUX mixing buses for effect-to-monitor sends.

38. EFX Return Control

This control adjusts the signal level of audio fed through to stereo AUX Return 3 inputs. If no device is plugged into the AUX Return 3 inputs, it then acts as the final level control of the built-in Digital Effect Engine.

39. Main L/R - Group Buttons

The first of these buttons changes the destination of the signal sent from the AUX Return 3 mix between the Main L/R and Group mix. The second button works when the user selects to send the signal "To Group", allowing the signal to be sent to either Group 1-2 or Group 3-4.

40. AUX Return 4 Control

This control adjusts the signal level of audio fed through to the stereo AUX Return 4 inputs. The accompanying "C-R Phones Only" button allows users to send the signal to the Control Room / Phones mixing bus for monitoring purposes.

41. Solo Returns Button

Pushing this button allows you to SOLO the signal from all AUX Returns, sending the signals to the Control Room / Phones mix. When the Returns are soloed, the corresponding LED indicator will illuminate.

42. AUX Send 1, 2 and 3/4 Master Controls

These controls adjust the final level of the AUX1, 2, 3 and 4 signals (as taken from the appropriate AUX level controls on channel strips) before being sent to the AUX sends. These mixes can be sent to the Control Room / Phones mix by pushing the corresponding SOLO buttons.

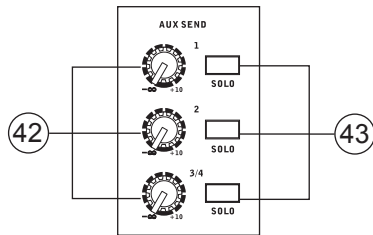

43. AUX Send Solo Buttons

Push these buttons to send the signals from the corresponding AUX Sends mixes to the Control Room / Phones mix. The AUX 3 mix will be sent to the left of the Control Room / Phones stereo mix, while the AUX 4 will be sent to the right.

44. Solo Control

When one or more solo buttons are activated on any channel, this control adjusts the signals' levels before sending the amplified signal to the Control Room / Phones mixing bus. This enables the user to be able to switch between monitoring the Main L-R (or other selected signals) and the solo signals without being overwhelmed by the difference in signal levels.

45. 2T / USB Return Controls

Turning the 2T Return level control adjusts the signal level of the feed from the 2T Return inputs, as well as the return signal from the computer through the USB interface. The "To Main L-R" button that accompanies this control allows users to send the 2T/USB return signal to the Main stereo mix. When this is done, the return signal is not sent to the Record Out, as to avoid producing a feedback loop when recorded signals are fed back into the 2T return.

46. Control Room / Phones Controls

These two controls are used to adjust the audio level of the Control Room and Phones feeds, for use in the monitoring and tracking of audio. The Control Room control adjusts the final level sent to the C-R outputs on the rear of the AM844D USB mixer, whereas the Phones control adjusts the final signal sent to the Phones A and B jacks on the top of the mixer's face.

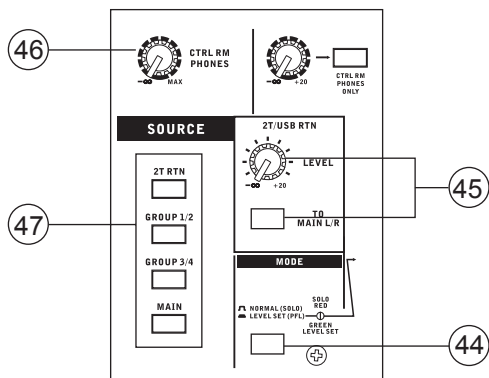

47. Control Room / Phones Source Selection

These four buttons allow users to select the various possible sources for the Control Room and Phones outputs. By simply pushing one of these buttons, users have the ability to monitor the Group 1-2, Group 3-4, Main L-R and 2T Return (by the Ctrl Rm / Phones only button) signals, either together or individually.

Priority	Signal
High	From Solo
Low	Selected Source(s)

48. +48V Indicator

This indicator will illuminate when Phantom Power is activated.

49. Power Indicator

The Power Indicator will light up when the power of the mixer is on; in case you weren't too sure.

50. Level Meter

This dual 12 segment level meter gives an accurate indication of when audio levels of the Main L/R signal reach certain levels. The 0 dB indicator illuminates, is approximately equal to an output level of +4 dBu (balanced), and the PEAK indicator illuminates about 1.5 dB before the signal is dynamically clipped. To make the maximum use of audio, set the various level controls so that it sits steadily around 0 dB to make full use of audio, while still maintaining fantastic clarity.

When the Solo indicator, located beside the Level Meter, is illuminated, one or more Solo buttons has been pushed; therefore the Level meter will display properties of the Solo signal, which is helpful with setting of channel properties. If Solo indicator illuminates green, this means the Solo feed is a pre-fader signal. If the solo indicator illuminates red, the feed is post-fader. If no Solo buttons are activated, the Control Room / Phones selected sources (Main L-R, Group 1-2, Group 3-4 and/or 2T Return) signal properties are displayed by the Level Meter. In this case, the Level meter will display the sum of the selected signals.

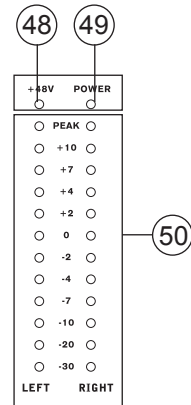

51. Group 1/5, 2/6, 3/7 and 4/8 Controls

These four faders are the final level control for the Group 1 to 4 audio feeds (the signals of which are doubled in the 5 – 8 Group outputs), sent to the corresponding Group outputs on the rear of the AM844D USB to feed external devices such as effect processors, and, most commonly, multi-track recorders. These faders can be fed a signal from the various mono and stereo channels, as well as the AUX Return 3, depending on your selections. When pushed all the way up, these faders provide 10 dB of gain to the signal, and, when set all the way down, effectively mute the signal.

The Group Controls also feature individual left and right buttons, which allow you to send the various Group signals to the Main Left and Right. This can be handy when wanting to combine the signals from different signals and control their input levels simultaneously, then send them to the Main L/R signal (eg. When multiple inputs are used for drums, you can combine these inputs together to be controlled much simpler by a single fader).

52. Main Fader

This fader is the final level control for the Main Left and Right audio feeds, sent to the Main L and R outputs. When pushed all the way up, the Main L/R fader provides 10 dB of gain to the signal, and when set all the way down, the signal is effectively muted. This will also adjust the final output level of the signal sent through the USB interface to the computer.

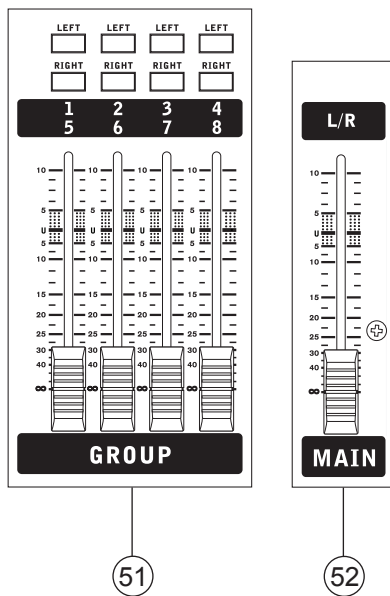

SPECIFICATIONS

English

Inputs	
Total Channels	12
Balanced Mono Mic / Line Channel	8
Balanced Mic / Stereo Line channel	2
Balanced Stereo Line Channel	2
AUX Return	4 stereo
2T Input	Mini stereo and stereo RCA
Outputs	
Main L/R Stereo	2 x 1/4" TRS, Bal. & 2 x XLR
Group	8
Rec Out	Mini stereo and stereo RCA
CTRL RM L/R	2 x 1/4" TS
Phones	2
Channel Strips	
EFX Send	4
Pan/Balance Control	Yes
Volume Controls	60mm fader
Inserts	8
Master Section	
Phones Level Control	Yes
Main L/R Level Control	60 mm fader
Level Meter	13-segment
Phantom Power Supply	+48V DC
Frequency Response (Mic input to any output)	
20Hz ~ 60KHz	+0/-1 dB
20Hz ~ 100KHz	+0/-3 dB
Crosstalk (1KHz @ 0dBu, 20Hz to 20KHz bandwidth, channel in to main L/R outputs)	
Channel fader down, other channels at unity	<-90 dB
Noise (20Hz~20KHz; measured at main output, Channels 1-4 unit gain; EQ flat; all channels on main mix; channels 1/3 as far left as possible, channels 2/4 as far right as possible. Reference=+6dBu)	
Master @ unity, channel fader down	-86.5 dBu
Master @ unity, channel fader @ unity	-84 dBu
S/N ratio, ref to +4	>90 dB
Microphone Preamp E.I.N. (150 ohms terminated, max gain)	<-129.5 dBm

THD (Any output, 1KHz @ +14dBu, 20Hz to 20KHz, channel inputs)	<0.005%
CMRR (1 KHz @ -60dBu, Gain at maximum)	80dB
Maximum Level	
Mic Preamp Input	+10dBu
All Other Input	+22dBu
Balanced Output	+28dBu
Impedance	
Mic Preamp Input	2 K ohms
All Other Input (except insert)	10 K ohms
RCA 2T Output	1.1 K ohms
Equalization	3-band, +/-15dB
Low EQ	80Hz
Mid EQ	100-8k Hz, sweepable
L-Mid EQ	800 Hz
H-Mid EQ	3 kHz
Hi EQ	12 kHz
Low Cut Filter	75 Hz (-18 dB/oct)
USB Audio	
	Stereo In/Out
Connector Type	USB Type B
Bitrate	16-bit
Sampling Rate	48 kHz
Digital Effect Processor	16 effects with parameter control
Footswitch	EFX on/off
Power Requirements	
	100-240 VAC, 50/60 Hz
Dimensions (WxHxD)	
	418 x 140 x 438 mm (16.5" x 5.5" x 17.25")
Weight	
	5.9 kg (13 lbs)

SERVICE AND REPAIR

For replacement parts, service and repairs please contact the Phonic distributor in your country. Phonic does not release service manuals to consumers, and advice users to not attempt any self repairs, as doing so voids all warranties. You can locate a dealer near you at <http://www.phonic.com/where/>.

WARRANTY INFORMATION

Phonic stands behind every product we make with a no-hassles warranty. Warranty coverage may be extended, depending on your region. Phonic Corporation warrants this product for a minimum of one year from the original date of purchase against defects in material and workmanship under use as instructed by the user's manual. Phonic, at its option, shall repair or replace the defective unit covered by this warranty. Please retain the dated sales receipt as evidence of the date of purchase. You will need it for any warranty service. No returns or repairs will be accepted without a proper RMA number (return merchandise authorization). In order to keep this warranty in effect, the product must have been handled and used as prescribed in the instructions accompanying this warranty. Any tampering of the product or attempts of self repair voids all warranty. This warranty does not cover any damage due to accident, misuse, abuse, or negligence. This warranty is valid only if the product was purchased new from an authorized Phonic dealer/distributor. For complete warranty policy information, please visit <http://www.phonic.com/warranty/>.

CUSTOMER SERVICE AND TECHNICAL SUPPORT

We encourage you to visit our online help at <http://www.phonic.com/support/>. There you can find answers to frequently asked questions, tech tips, driver downloads, returns instruction and other helpful information. We make every effort to answer your questions within one business day.

support@phonic.com
<http://www.phonic.com>

PHONIC

DIGITAL EFFECT TABLE TABLA DE EFECTO DIGITAL

Program Number	Program Name	Parameter	Parameter Range
1	Small Hall	Reverb Time (S)	0.3 to 1.1
2	Mid Room	Reverb Time (S)	0.1 to 0.45
3	Plate	Reverb Time (S)	0.9 to 1.45
4	Cathedral	Reverb Time (S)	1.1 to 3.8
5	Mid Hall	Reverb Time (S)	0.5 to 1.66
6	Jazz Lounge	Reverb Time (S)	0.15 to 0.9
7	Ping Pong Delay	Delay Average (S)	0.08 to 0.55
8	Short Delay	Delay Average (S)	0.05 to 0.4
9	Vocal Plate	Reverb Time (S)	0.2 to 2.2
10	Concert Hall	Reverb Time (S)	0.3 to 2.45
11	Stage	Reverb Time (S)	0.6 to 1.6
12	Doubler	Feedback Ratio	20% to 90%
13	Echo	Delay Average (S)	0.12~0.55
14	Chorus	LFO	0.66~9.6
15	Chorus + Rev	LFO Reverb Time (S)	0.8 to 8.8 0.4 to 0.8
16	Spring	LFO	0.16 to 1.33

APPLICATION

There are potentially hundreds of ways to connect instruments and devices to the AM mixers. It is advisable that you explore the functions and find the best setup possible for your needs, which may depend on what instruments you wish to connect, as well as how many external devices you wish to connect and your required monitoring applications. Combining the use of different instruments with the mixer's special functions will ensure that your audio sounds exactly the way you want it.

APLICACIÓN

Existen cientos de maneras posibles de conectar instrumentos y dispositivos a las mezcladoras AM. Se recomienda que explore las funciones y encuentre la mejor configuración posible para sus necesidades, que dependerá de qué instrumentos y cuántos dispositivos externos se quiere conectar y sus aplicaciones de monitoreo requeridas. Combinando el uso de diferentes instrumentos con las funciones especiales de la mezcladora asegurará que su audio se escucha exactamente como usted quiere.

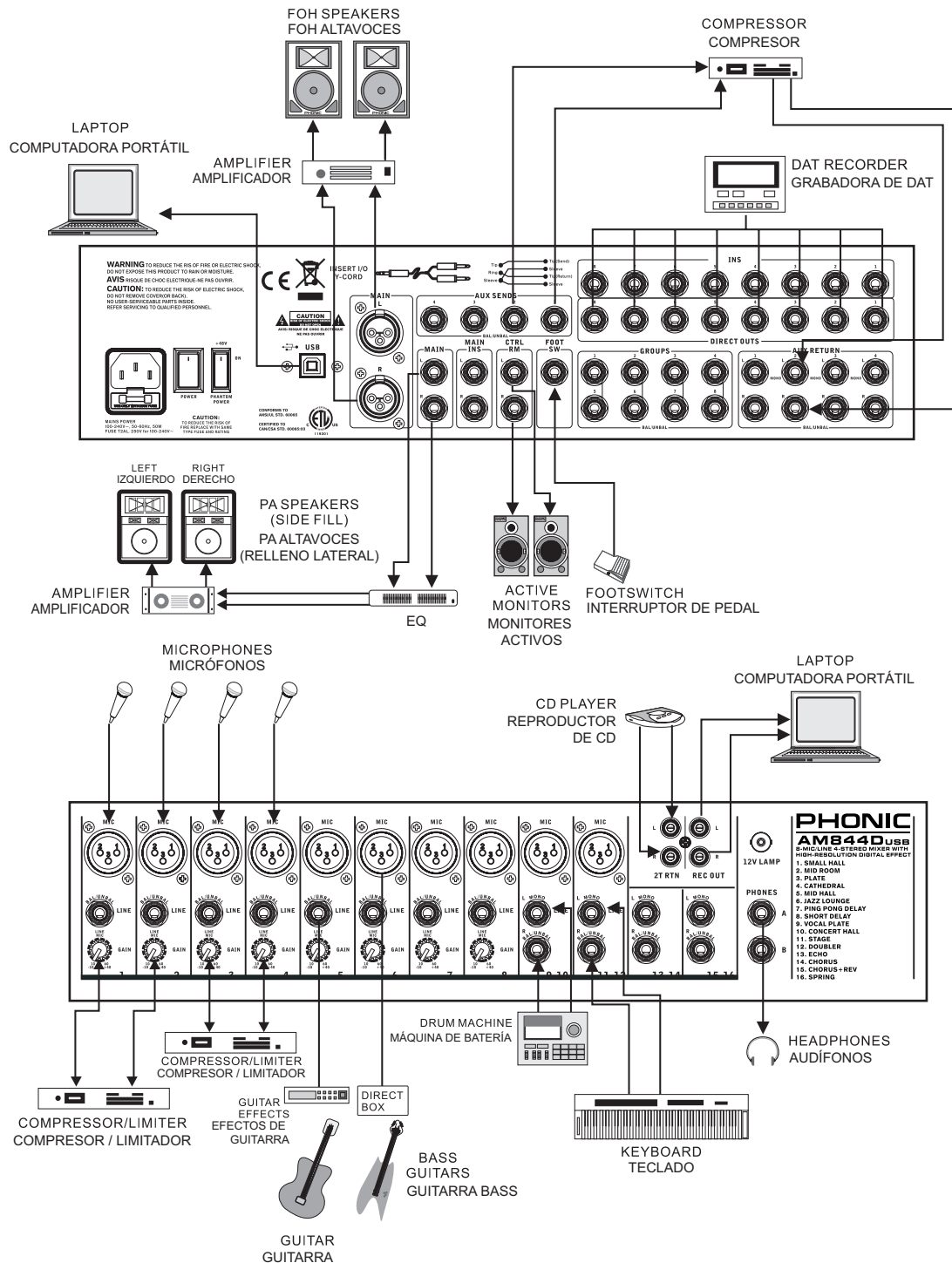

DIMENSIONS

DIMENSION

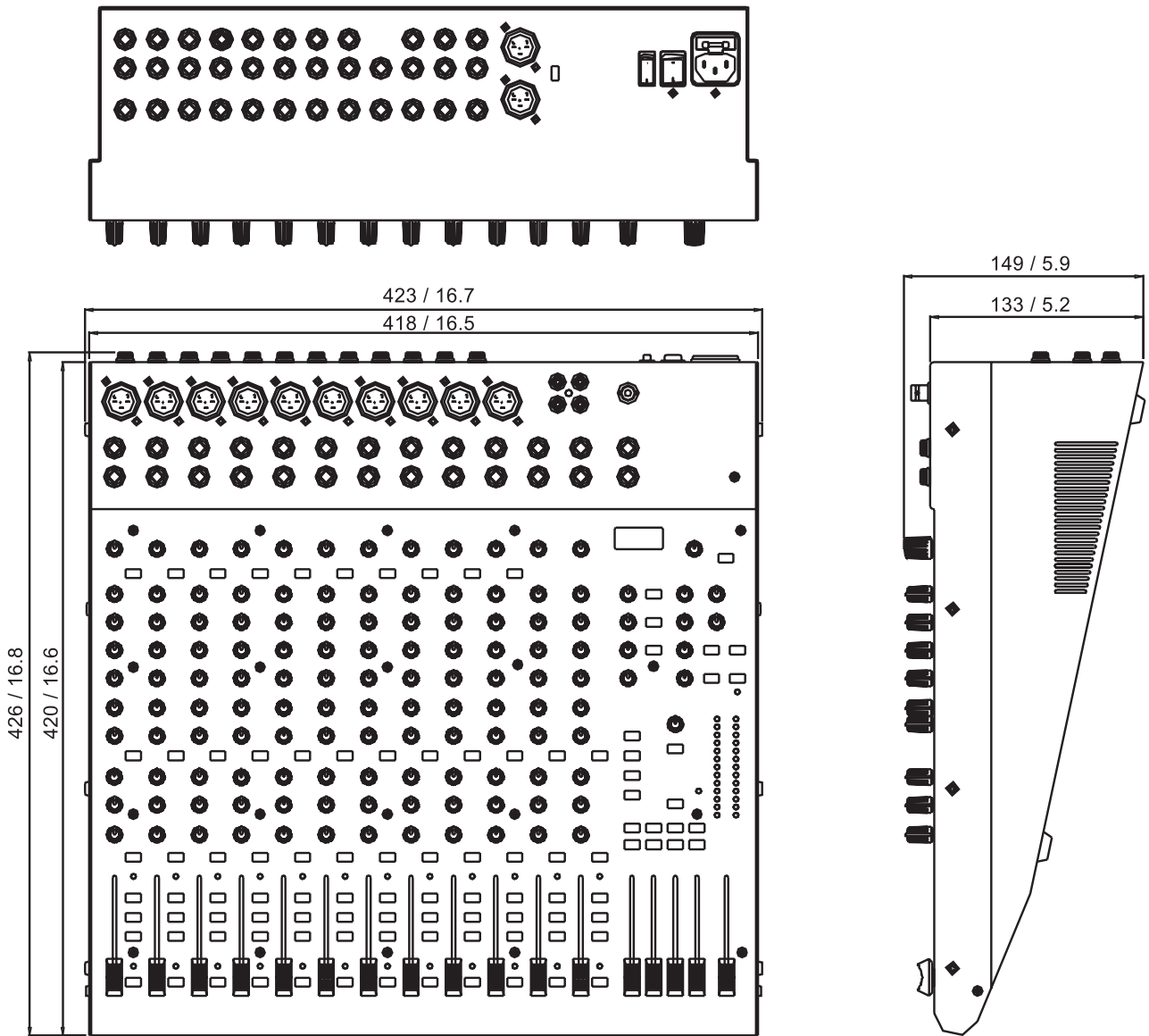

All measurements are shown in mm/inches.
 Todas las medidas están mostradas en mm/pulgadas.

BLOCK DIAGRAM DIAGRAMA DE BLOQUE

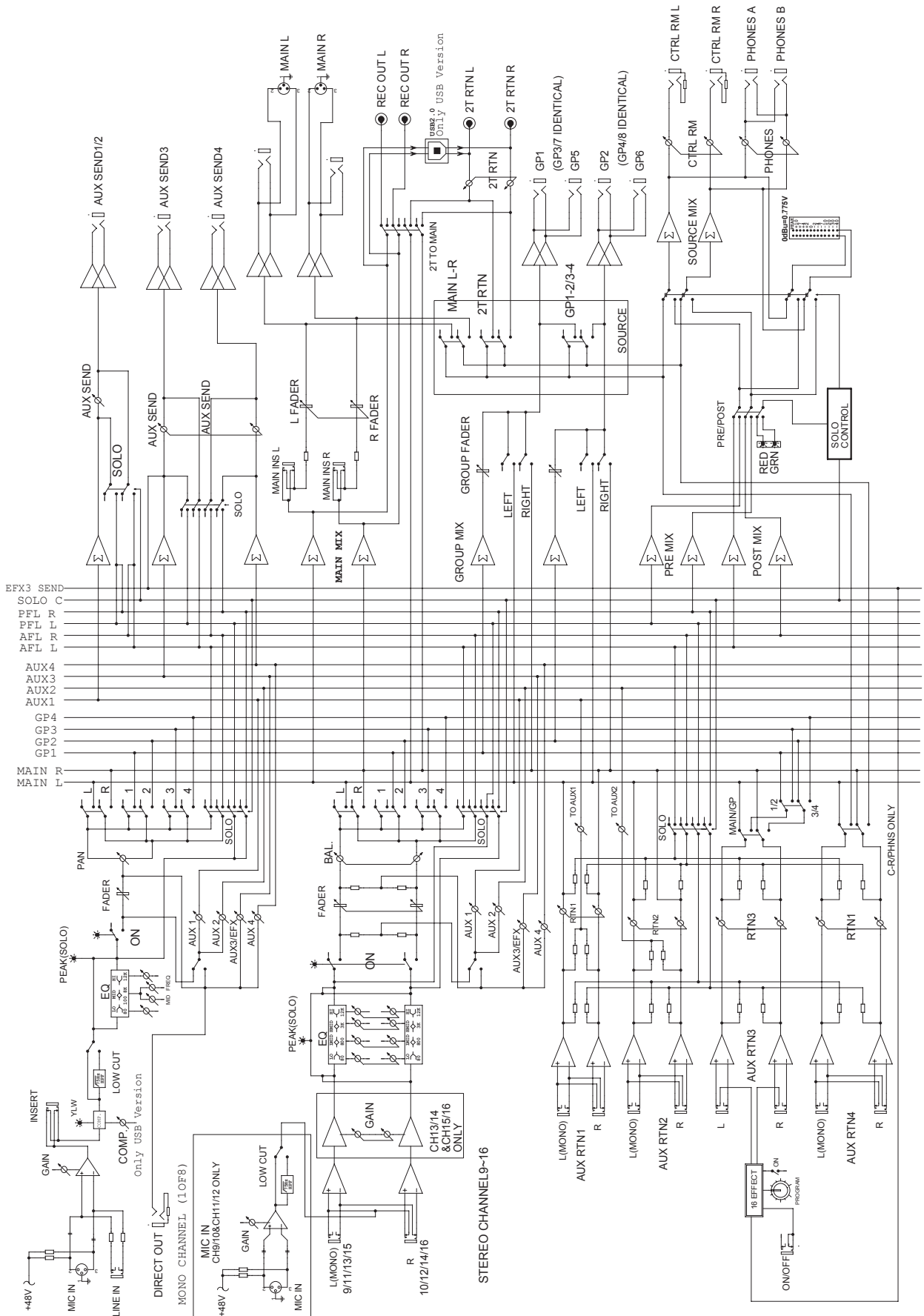

MEMO

Lined area for writing a memo, consisting of 25 horizontal lines.

PHONIC
WWW.PHONIC.COM