



Features

- » 2-way vented loudspeaker system
- » 8" speaker
- » 1" soft dome ferrofluid cooled tweeter
- » Wide coverage
- » Built-in line transformer
- » Hi-fi sound character
- » Highly resistant polypropylene enclosure
- » Punched steel grilles
- » Horizontal or vertical use

INTRODUCTION

The D.A.S. FACTOR 8 is a versatile 2-way vented loudspeaker system with a hi-fi sound character. The FACTOR 8T adds a built-in multi-tap transformer for use in distributed applications.

APPLICATIONS

The FACTOR 8T may be used whenever a large number of quality speakers is called for, such as restaurants or hotels, for which 50, 70 or 100 volt lines are used.

DESCRIPTION

The low end utilizes a 8" low frequency speaker with 1.5" voice coil. The top end makes use of a 1" soft dome tweeter.

The FACTOR 8 features low directivity design, so it will deliver a broad coverage to audience areas.

Full use of high pressure injection moulding techniques has achieved a mineral loaded polypropylene cabinet of a very high density. Internal design provides extensive wall reinforcing for minimum vibration. A moulded-in handle facilitates carrying. Additionally, steel grilles protect the components.

An optional wall mounting bracket allows swivel as well vertical or horizontal angling.

SPECIFICATIONS

Transformer RMS Power Handling:	60 W
RMS (Average) Power Handling^R:	100 W
Program Power Handling^P:	200 W
Peak Power Handling^K:	>400 W
Frequency Response^F:	55 Hz - 22 kHz
Total System Impedance^I:	82/163/335/670/1340/2680 Ω
Loudspeaker Nominal Impedance^I:	8 Ω
On-axis Sensitivity 1W / 1 m^S:	91 dB SPL
Nominal -6 dB Beamwidths^B:	145° Horizontal
(average, 500 Hz to 8 kHz)	135° Vertical
Speech Coverage Angles^C:	155° Horizontal x 150° Vertical
Enclosure Material:	Mineral loaded polypropylene
Color:	Black or white
Transducers/Replacement Parts:	Bass: G-8/GM G-8 HF: TWT-8/GM TWT-8
Connector:	Spring loaded push terminals
Dimensions (H x W x D):	44 x 27 x 23 cm (17.5 x 10.5 x 9 in)
Weight:	8.1 kg (18 lbs)
Shipping Weight:	9.2 kg (20 lbs)
Accessories (optional):	AX-8 wall/ceiling mount

^R Based on a 2 hour test using a 6 dB crest factor signal bandlimited according to IEC 268-1 (1985). All power ratings are referred to the nominal impedance.

^P Conventionally 3 dB higher than the RMS measure, although this already utilizes a program signal.

^K Corresponds to the signal crests for the test described in ^R.

^F As per IEC 268-5 (1989), re. a one octave band centered at 3 kHz. Half space anechoic.

^I In practice cable and connector impedance has to be added to all impedance values.

^S For the 3 kHz one octave band.

^B Average of one-third octave band measures.

^C There is currently no standard method of averaging the beamwidth with frequency characteristics into a single meaningful figure, which impedes comparisons across manufacturers and very often even product lines. This, our own, criterion weighs the -6 dB coverage angles from one-octave bands according to their contribution to speech intelligibility. One and one-third octave bands comply to ANSI S1.11-1986.

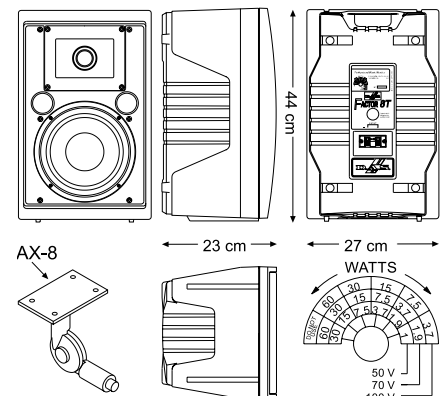

Frequency Response

Figure 1 shows the fundamental frequency response at 1 m of a unit radiating to a half space anechoic environment and driven by a 1 W swept sine signal.

Impedance

Figure 2 shows impedance with frequency for the available transformer taps.

Distortion

Figure 3 shows the Total Harmonic Distortion Plus Noise (solid), Second Harmonic Distortion (dashed) and Third Harmonic Distortion (dotted) curves for a unit driven at 10 W.

Beamwidth

Figure 4 shows the -3, -6 and -10 dB horizontal (solid) and vertical (dashed) beamwidth with frequency curves. -6 dB ones are shown with thicker traces for clarity.

Axial Directivity $Q(R_0)$ and D_i

Figure 5 shows the above characteristics with frequency.

Polar Response

Figure 6 shows the one octave band horizontal (solid) and vertical (dashed) polars for the indicated frequencies. Full scale is 50 dB, 5 dB per division.

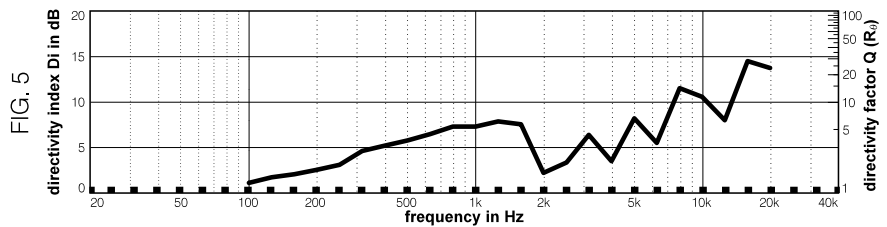
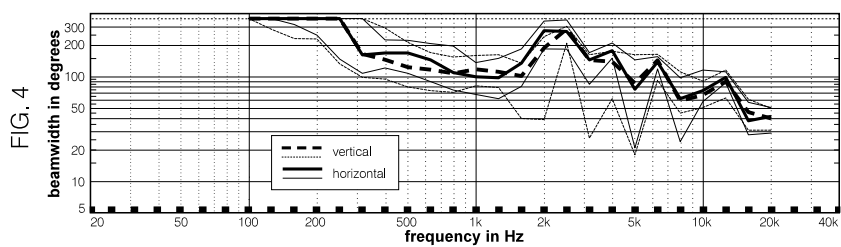
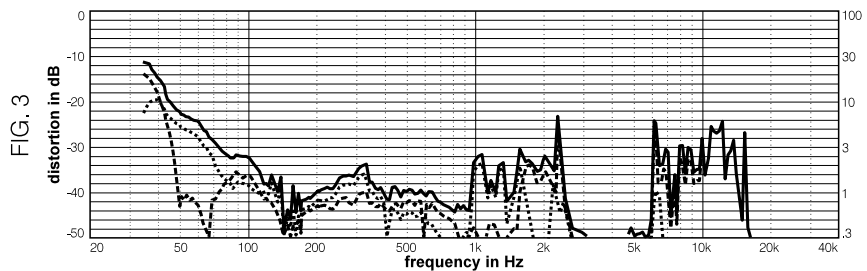
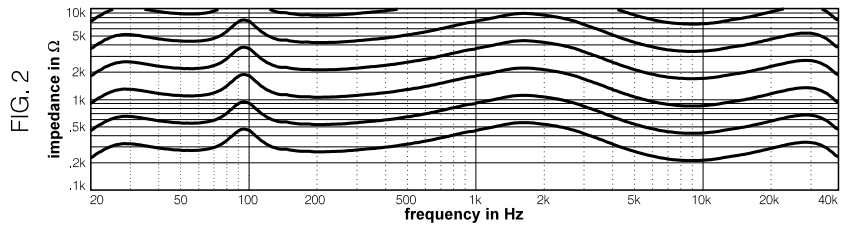
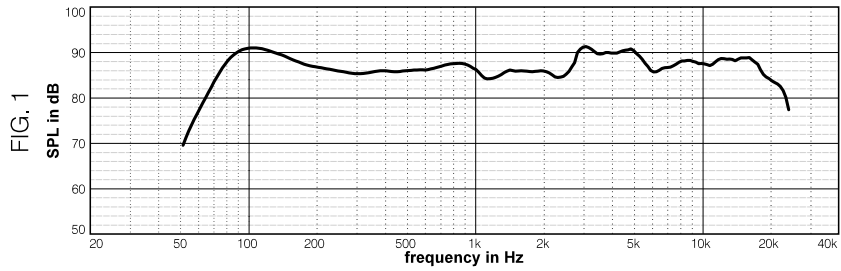

NOTES. 1.Frequency response : referred to 1 m; low end obtained through the use of near field techniques;one-third octave smoothed for correlation with human hearing. 2.In practice, cable and connector impedance need to be added. 3.Harmonic distortion components are not plotted beyond 20 kHz; THD+N is 22 Hz - 22 kHz filtered; near-field techniques used. 4.Directivity characteristics plotted with respect to frequency are the average within the one-third octave bands of center frequencies noted by the marks at the bottom of the graphs, but are joined up for display purposes. All other characteristics plotted vs. frequency use 1/24th octave resolution. Notches of less than 1 dB below goal level may be ignored when calculating beamwidths. 5.Directivity factor and index were computed from two degree resolution vertical and horizontal polars using sinusoidal weighting. 6.Polars were acquired by placing the unit on a computer controlled turntable inside our anechoic chamber. Measurement distance was 3 m. Product improvement through research and development is a continuous process at D.A.S. Audio. All specifications subject to change without notice.

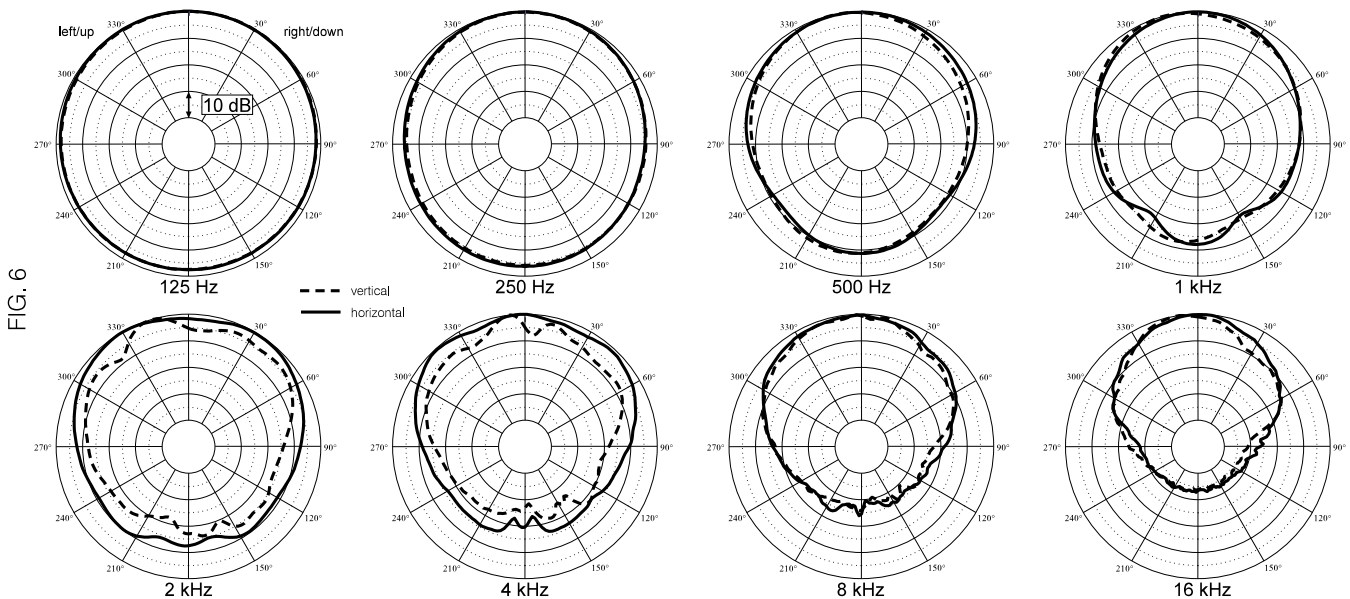

D.A.S. Audio, s.a. - C/ Islas Baleares, 24 - 46988 Pol. Ind. Fuente del Jarro - Valencia, SPAIN
 Tel. 96 134-0525 - Tel. Intl. +34-96-134-0860 - Fax. 96 134-0607 - Fax. Intl +34-96-134-0607 - <http://www.dasaudio.com>
 D.A.S. Audio of America, Inc. - 6970 N.W. 50th St. - Miami, FL. 33166 - U.S.A.
 Tel. 305 436 0521 - Fax. 305 436 0528