

Install Speakers

PRAGUE

TPA122/00-WH

Arrayable 2 Way 12" Full Range Loudspeaker
for Installation Applications,
100° H x 100° V Dispersion (White)

- Arrayable 2 way full range loudspeaker for installation applications
- Wide 100° H x 100° V dispersion waveguide
- 500 Watts continuous, 2,000 Watts peak power
- Carbon fibre loaded 12" low frequency driver with inside/outside wound coil
- Aluminium dome 1" neodymium motor compression driver
- Multiple array configurations for extended coverage
- Switchable passive/bi-amp operation for flexibility of use
- Trapezoidal cabinet shape enables visually unobtrusive loudspeaker arrays
- Multiple internal rigging points allow bracket mount and suspension in any orientation
- 15 mm (5/8") birch plywood enclosure with hard wearing semi matt white paint finish
- Architecturally styled powder coated perforated steel mesh grille
- Neutrik speakON* NL4 and barrier strip connectors
- 3-Year Warranty Program*
- Designed and engineered in England



The 2-way full range TPA122/00-WH is a switchable passive/bi-amp 12" 2,000 Watt arrayable loudspeaker system that is ideally suited for a wide range of speech and music sound reinforcement applications. The TPA122/00-WH is designed to work in conjunction with **TURBOSOUND** loudspeaker management systems, providing optimal FOH performance, as well as offering considerable flexibility to readily adapt to varying venue requirements.



The TPA122/00-WH arrayable loudspeaker features a carbon fibre loaded 12" low frequency driver with inside/outside wound coil with low mass voice coil for improved transient response, and an aluminium dome 1" neodymium motor compression driver mounted on a 100° horizontal by 100° vertical waveguide. All drivers are matched with an internal passive crossover network in a reflex-loaded enclosure, and bi-amp mode can be enabled by means of a rear panel switch.

Finished in a highly durable semi matt white paint, the cabinet is constructed from 15 mm (5/8") birch plywood – and includes a rugged powder coated perforated steel mesh grille backed with reticulated foam. Internal M10 threaded rigging points are provided for suspension in any orientation, or mounting with dedicated brackets – available separately. The rear panel connector plate carries Neutrik speakON* NL4 and barrier strip connectors for input and link connections to additional enclosures.

Install Speakers

PRAGUE

TPA122/00-WH

Arrayable 2 Way 12" Full Range Loudspeaker
for Installation Applications,
100° H x 100° V Dispersion (White)



You Are Covered

We always strive to provide the best possible Customer Experience. Our products are made in our own MUSIC Group factory using state-of-the-art automation, enhanced production workflows and quality assurance labs with the most sophisticated test equipment available in the world. As a result, we have one of the lowest product failure rates in the industry, and we confidently back it up with a generous 3-Year Warranty program.

Install Speakers

PRAGUE TPA122/00-WH

Arrayable 2 Way 12" Full Range Loudspeaker
for Installation Applications,
100° H x 100° V Dispersion (White)

Frequency Response Sensitivity 1 W / 1 m

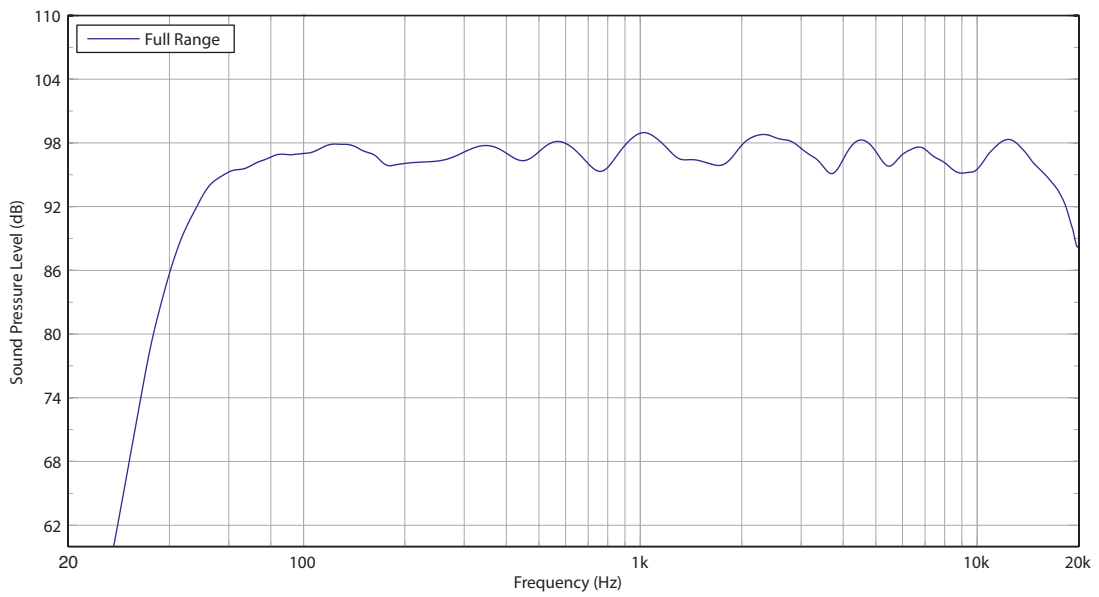

Impedance

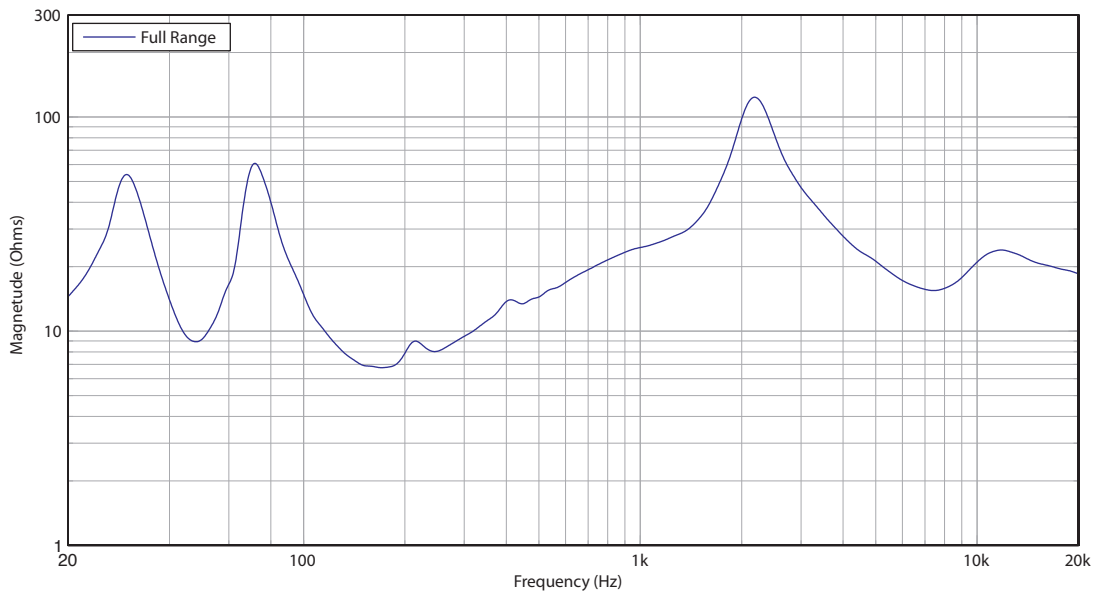

Install Speakers

PRAGUE TPA122/00-WH

Arrayable 2 Way 12" Full Range Loudspeaker
for Installation Applications,
100° H x 100° V Dispersion (White)

Horizontal Beamwidth

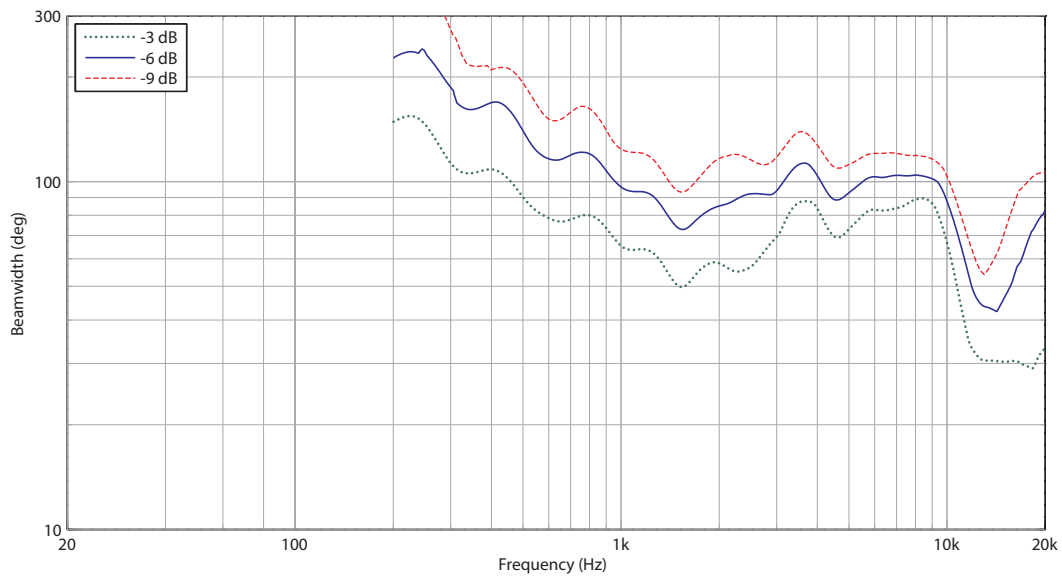

Vertical Beamwidth

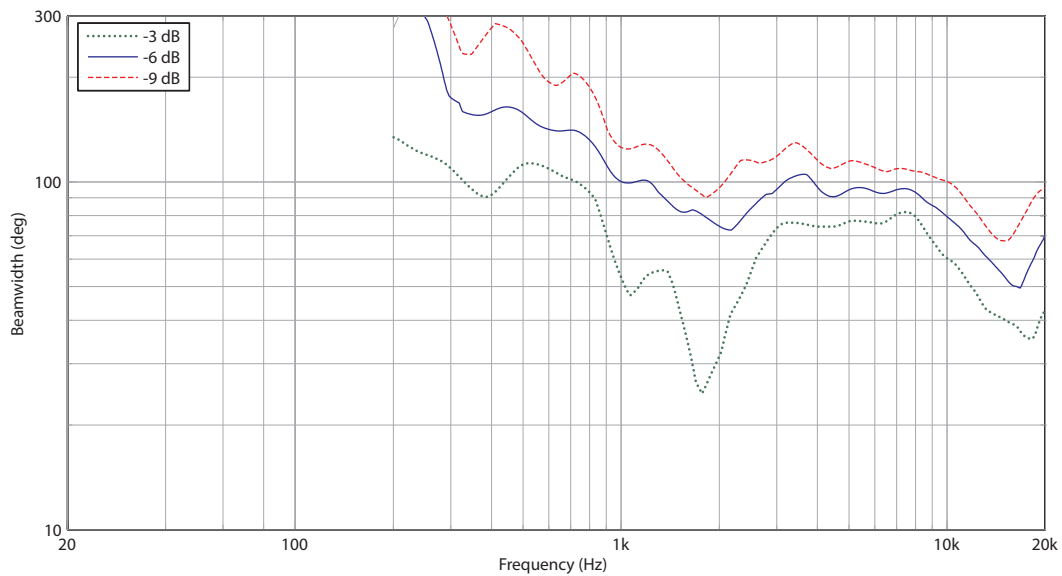

Install Speakers

PRAGUE TPA122/00-WH

Arrayable 2 Way 12" Full Range Loudspeaker
for Installation Applications,
100° H x 100° V Dispersion (White)

Horizontal Polar Plots

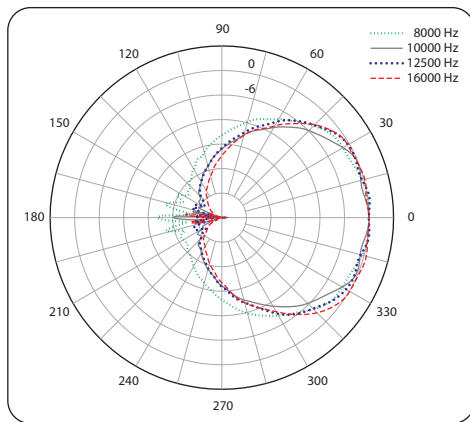
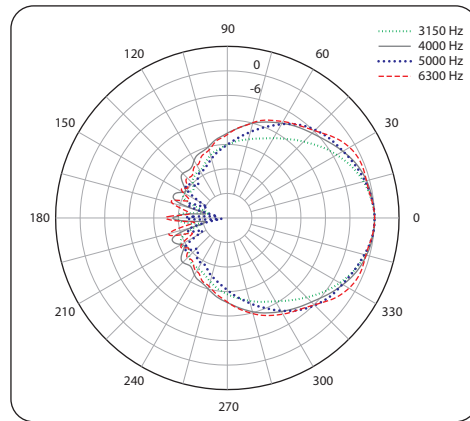
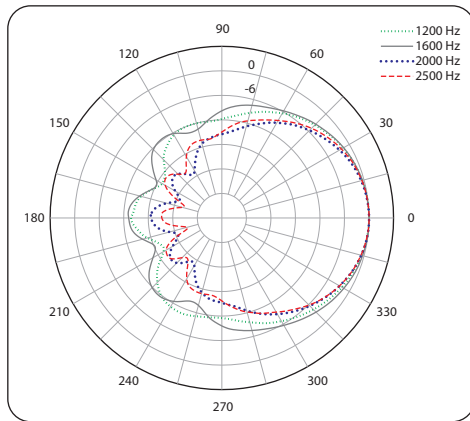
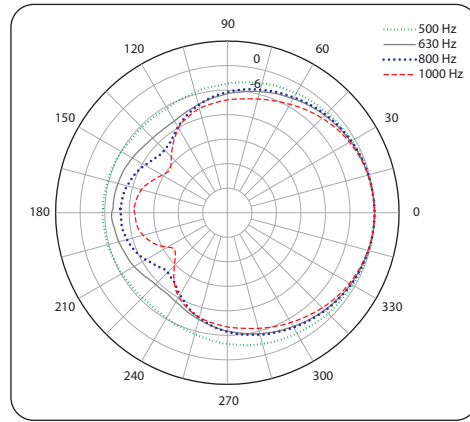
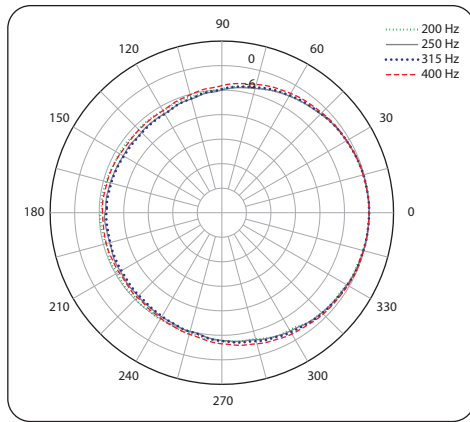

Install Speakers

PRAGUE TPA122/00-WH

Arrayable 2 Way 12" Full Range Loudspeaker
for Installation Applications,
100° H x 100° V Dispersion (White)

Vertical Polar Plots

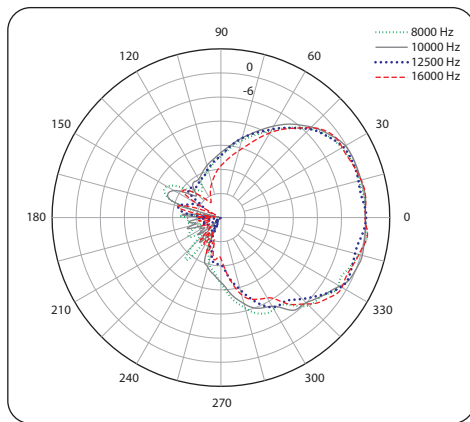
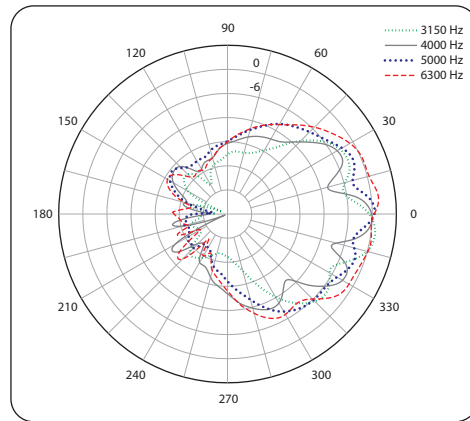
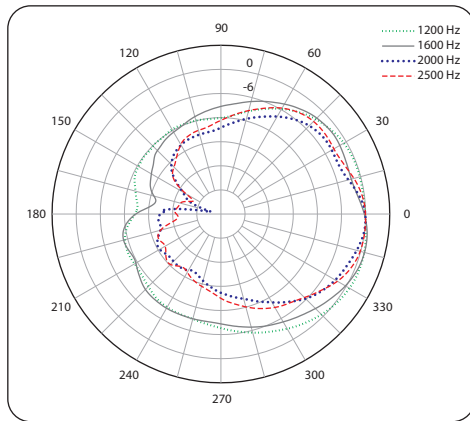
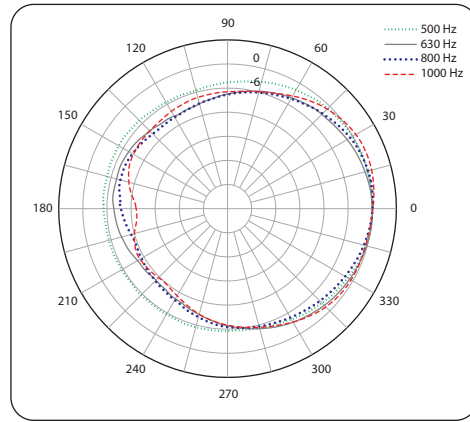
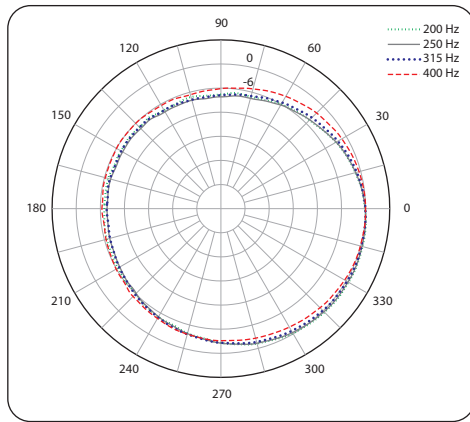

Install Speakers

PRAGUE

TPA122/00-WH

Arrayable 2 Way 12" Full Range Loudspeaker
for Installation Applications,
100° H x 100° V Dispersion (White)

Dimensions

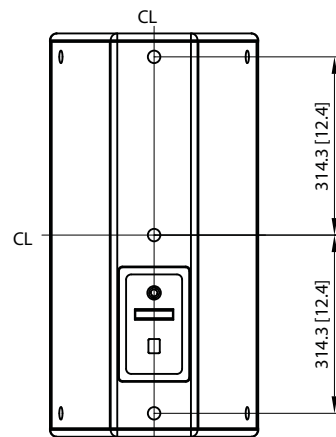
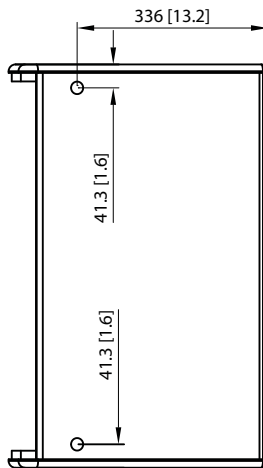
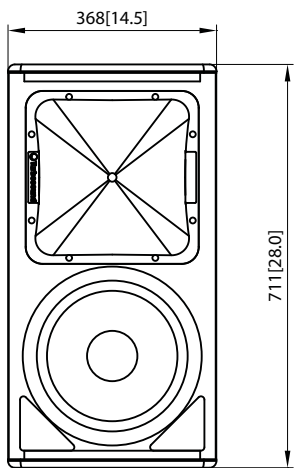
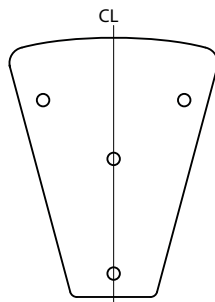
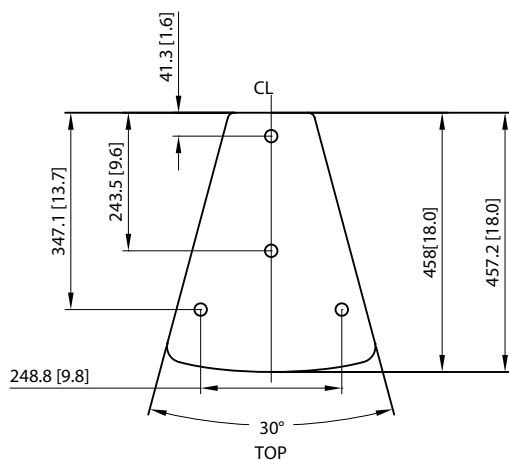

Install Speakers

PRAGUE TPA122/00-WH

Arrayable 2 Way 12" Full Range Loudspeaker
for Installation Applications,
100° H x 100° V Dispersion (White)

Mounting and Rigging

The cabinet is fitted with a quantity of 15 M10 internally-threaded rigging points on the top, bottom, sides and rear, that allow it to be rigged with M10 eyebolts and mounted in a variety of ways to suit differing applications.

An adjustable wall bracket (TPA122-WB) enables the cabinet to be fixed to a ceiling or wall, with the ability to rotate and adjust the angle to achieve optimum coverage.

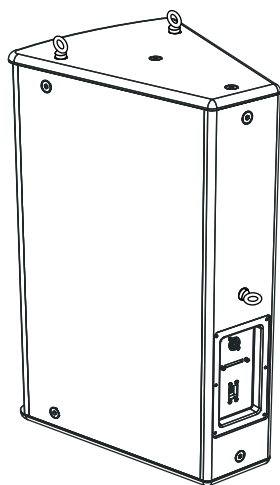
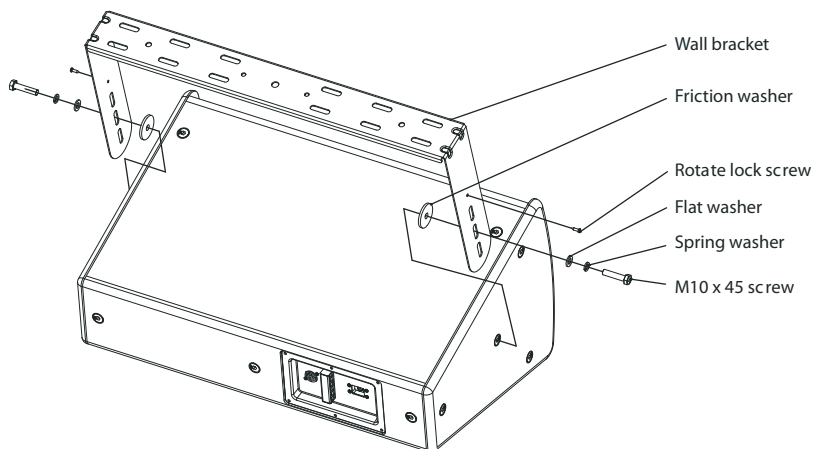

Eye-Bolt Rigging

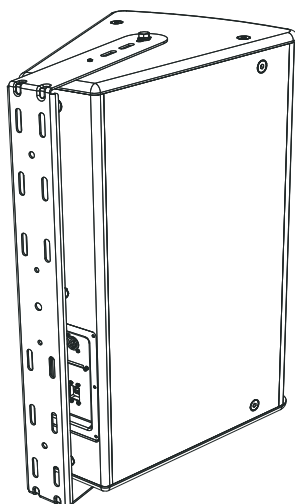

Vertical Mounting

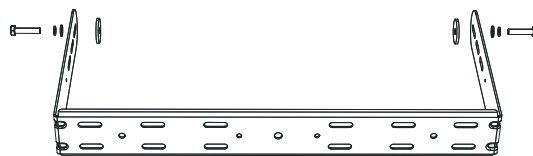

Wall Bracket Kit TPA122-WB

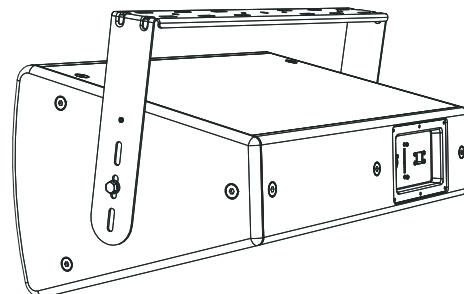

Horizontal Mounting

Install Speakers

PRAGUE

TPA122/00-WH

Arrayable 2 Way 12" Full Range Loudspeaker
for Installation Applications,
100° H x 100° V Dispersion (White)

Technical Specifications

System

Frequency Response	45 Hz – 18 kHz \pm 3 dB 40 Hz – 20 kHz -10 dB
Nominal Dispersion	100° H X 100° V @ -6 dB points
Directivity Factor (Q)	5
Directivity Index (DI)	7
Power Handling (IEC)	
Passive	500 W continuous, 2,000 W peak
Bi-amp	LF: 500 W continuous, 2,000 W peak HF: 40 W continuous, 160 W peak
Sensitivity	97 dB (1 W @ 1 m)
Maximum SPL	
Passive	124 dB continuous, 130 dB peak
Bi-Amp	LF: 124 dB continuous, 130 dB peak HF: 122 dB continuous, 128 dB peak
Impedance	
Passive	8 Ω
Bi-Amp	LF: 8 Ω HF: 6 Ω
Crossover Type	Passive / bi-amp, switchable
Components	1 x 12" (316 mm) LF driver 1 x 1" (25 mm) HF compression driver

Enclosure

Connectors	1 x Neutrik speakON* NL4, 1 x barrier strip terminals
Wiring	
Passive	Pins 1+ / 1- input, pins 2+ / 2- link
Bi-Amp	Pins 1+ / 1- LF, pins 2+ / 2- HF
Dimensions HWD	711 x 368 x 458 mm (28 x 14.5 x 18")
Net Weight	23.2 kg (51.1 lbs)
Construction	15 mm (5/8") birch plywood
Finish	Semi matt white paint
Grille	Powder-coated perforated steel
Flying Hardware	M10 x 15 points

Accessories

TPA122-WB wall bracket PRAGUE 12"

Install Speakers

PRAGUE

TPA122/00-WH

Arrayable 2 Way 12" Full Range Loudspeaker
for Installation Applications,
100° H x 100° V Dispersion (White)

Architecture & Engineering Specifications

The speaker shall be of the full range, two-way switchable bi-amp/passive type consisting of one 12" (316 mm) LF driver and one 1" (25 mm) HF compression driver. Performance specifications of a typical production unit shall meet or exceed the following: frequency response, measured with swept sine wave input, shall be flat within ± 3 dB from 45 Hz to 18 kHz and within -10 dB from 40 Hz to 20 kHz. Nominal dispersion, at -6 dB points, shall average 100° H x 100° V. Nominal impedance shall be HF: 6 Ohms, LF: 8 Ohms; passive: 8 Ohms. Power handling shall be HF: 40 Watts continuous, 160 Watts peak, LF: 500 Watts continuous, 2,000 Watts peak; passive: 500 Watts continuous, 2,000 Watts peak. Sensitivity, measured on axis, mean averaged over stated bandwidth, shall be 97 dB, 1 Watt @ 1 metre. Maximum SPL (peak) measured at 1 metre with music program at stated amplifier input shall be HF: 128 dB, LF: 130 dB; passive: 130 dB. Dimensions: 711 mm high x 368 mm wide x 458 mm deep (28.0" x 14.5" x 18.0"). Net weight: 23.2 kg (51.1 lbs). The loudspeaker system shall be the [TURBOSOUND TPA122/00-WH](#). No other loudspeaker shall be acceptable unless submitted data from an independent test laboratory verifies that the above combined performance / size specifications are equaled or exceeded.

Install Speakers

PRAGUE

TPA122/00-WH

Arrayable 2 Way 12" Full Range Loudspeaker
for Installation Applications,
100° H x 100° V Dispersion (White)

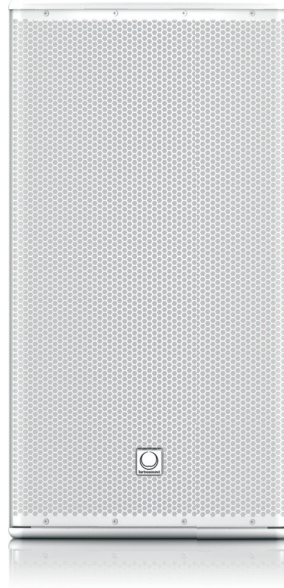

Install Speakers

PRAGUE

TPA122/00-WH

Arrayable 2 Way 12" Full Range Loudspeaker
for Installation Applications,
100° H x 100° V Dispersion (White)

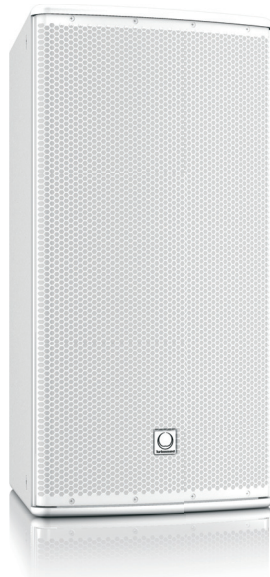

Install Speakers

PRAGUE TPA122/00-WH

Arrayable 2 Way 12" Full Range Loudspeaker
for Installation Applications,
100° H x 100° V Dispersion (White)

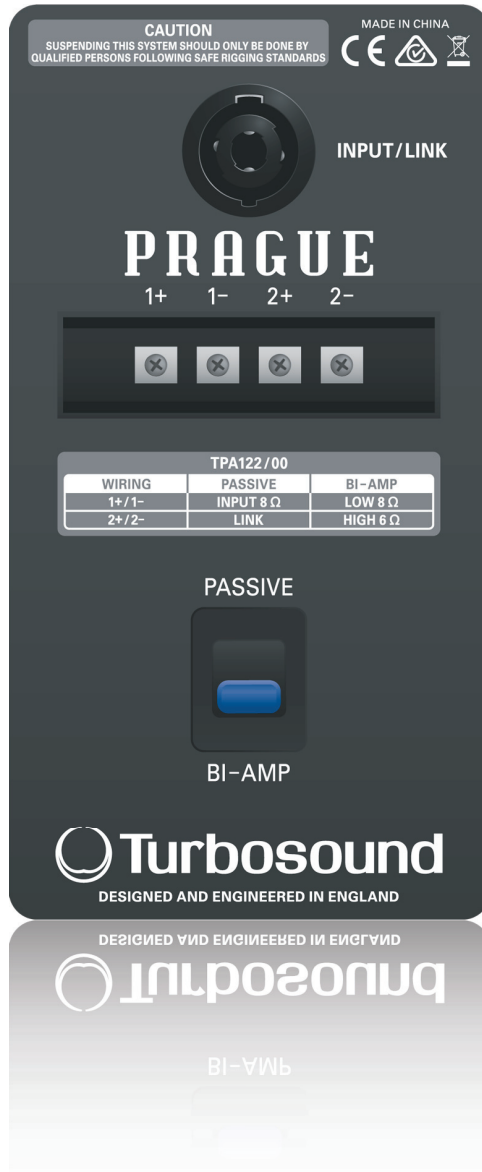

For service, support or more information contact the TURBOSOUND location nearest you:

Europe
MUSIC Group Services UK
Tel: +44 156 273 2290
Email: CARE@music-group.com

USA/Canada
MUSIC Group Services NV Inc.
Tel: +1 702 800 8290
Email: CARE@music-group.com

Japan
MUSIC Group Services JP K.K.
Tel: +81 3 6231 0454
Email: CARE@music-group.com

MUSIC Group accepts no liability for any loss which may be suffered by any person who relies either wholly or in part upon any description, photograph, or statement contained herein. Technical specifications, appearances and other information are subject to change without notice. All trademarks are the property of their respective owners. MIDAS, KLARK TEKNIK, LAB GRUPPEN, LAKE, TANNÖY, TURBOSOUND, TC ELECTRONIC, TC HELICON, BEHRINGER, BUGERA and DDA are trademarks or registered trademarks of MUSIC Group IP Ltd.
© MUSIC Group IP Ltd. 2016 All rights reserved.

