

Portable Speakers

NuQ122

2 Way 12" Full Range Loudspeaker for Portable PA and Installation Applications

- 2 way full range loudspeaker for portable PA and installation applications
- 400 Watts continuous, 1,600 Watts peak power
- Ideal for FOH, side fill and monitor applications
- 12" low frequency driver with low mass voice coil for improved transient response
- Aluminium dome 1" neodymium motor compression driver
- Low distortion waveguide provides 70° H x 70° V dispersion
- 15 mm (5/8") birch plywood enclosure with hard wearing semi matt black paint finish
- Rugged powder coated perforated steel mesh grille
- Integral 35 mm pole mount and handles
- Multiple internal rigging points allow bracket mount and suspension in any orientation
- Neutrik speakON* NL4 connectors for reliable long life operation
- 3-Year Warranty Program*
- Designed and engineered in England

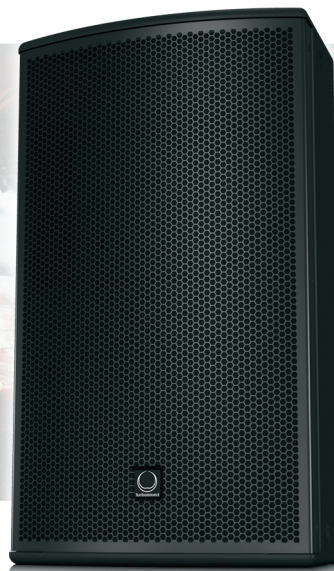

The 2 way full range NuQ122 is a switchable passive/bi-amp 1,600 Watt 12" loudspeaker system ideally suited for a wide range of speech and music sound reinforcement applications. Engineered to work in conjunction with **TURBOSOUND** loudspeaker management systems, the NuQ122 provides optimal performance for FOH, sidefill and delay line loudspeakers, and is an exceptional choice for wedge monitoring applications. The symmetrical trapezoidal shape and high frequency dispersion pattern also make the NuQ122 an obvious choice for mirrored left/right monitor wedge placement.



The NuQ122 loudspeaker features a 12" low frequency driver with a low mass voice coil for improved transient response, and an aluminium dome 1" neodymium high frequency compression driver mounted on a 70° horizontal by 70° vertical dispersion low distortion waveguide. All drivers are matched with an internal passive crossover network in a reflex-loaded enclosure, and bi-amp mode can be enabled by means of a rear panel switch. The rear panel connector plate carries Neutrik speakON* NL4 connectors for input and link connections to additional enclosures.

Finished in a highly durable semi matt black paint, the cabinet is constructed from 15 mm (5/8") birch plywood – and includes a rugged powder coated perforated steel mesh grille backed with reticulated foam. Multiple threaded rigging points are provided for suspension in any orientation, or for mounting with industry standard wall brackets. An optional flying yoke allows for further flexibility in install applications (available separately). The NuQ122 also features a 35 mm socket for standard pole mounting – plus integrated handles for convenient transport.

*All third-party trademarks are the property of their respective owners. Their use neither constitutes a claim of the trademark nor affiliation of the trademark owners with MUSIC Group. Product names are mentioned solely as a reference for compatibility, effects and/or components. Warranty details can be found at music-group.com.

Portable Speakers

NuQ122

2 Way 12" Full Range Loudspeaker for
Portable PA and Installation Applications



You Are Covered

We always strive to provide the best possible Customer Experience. Our products are made in our own [MUSIC Group](#) factory using state-of-the-art automation, enhanced production workflows and quality assurance labs with the most sophisticated test equipment available in the world. As a result, we have one of the lowest product failure rates in the industry, and we confidently back it up with a generous [3-Year Warranty program](#).

Portable Speakers

NuQ122

2 Way 12" Full Range Loudspeaker for
Portable PA and Installation Applications

Frequency Response Sensitivity 1 W / 1 m

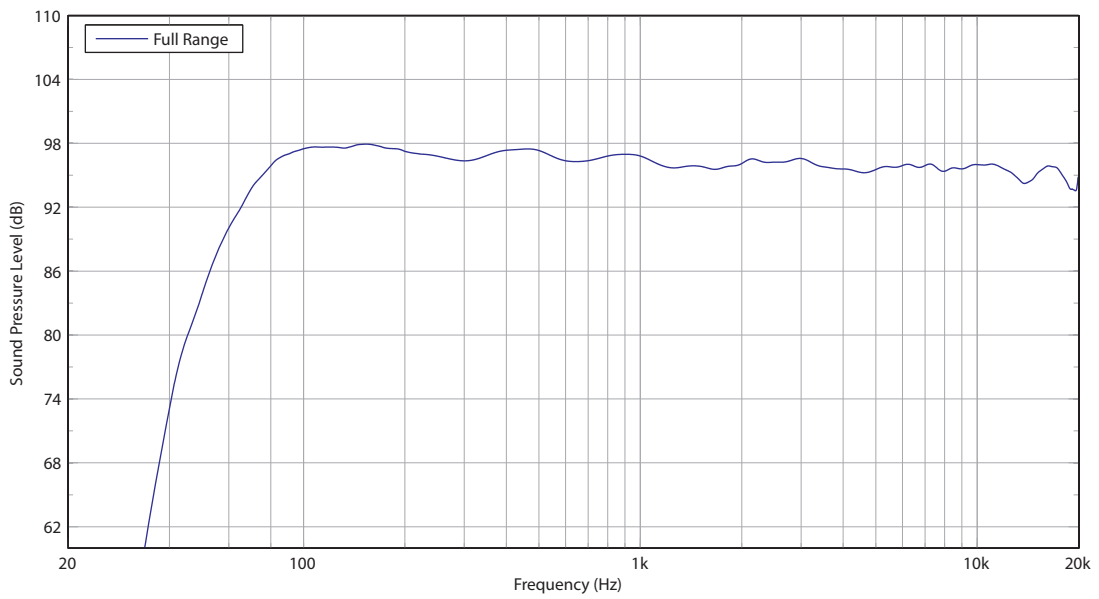

Impedance

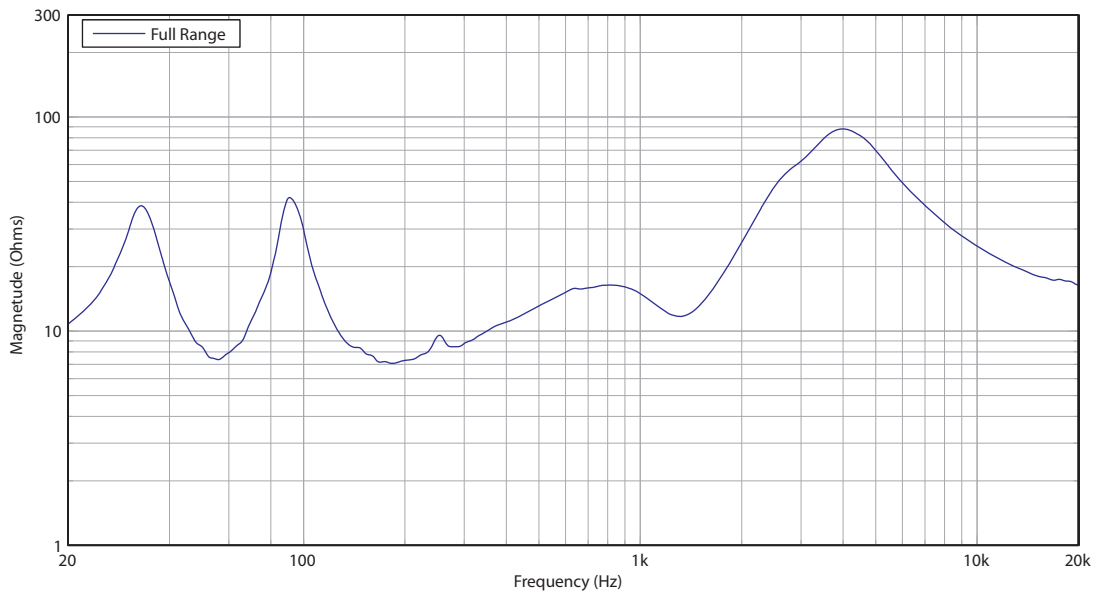

Portable Speakers

NuQ122

2 Way 12" Full Range Loudspeaker for
Portable PA and Installation Applications

Horizontal Beamwidth

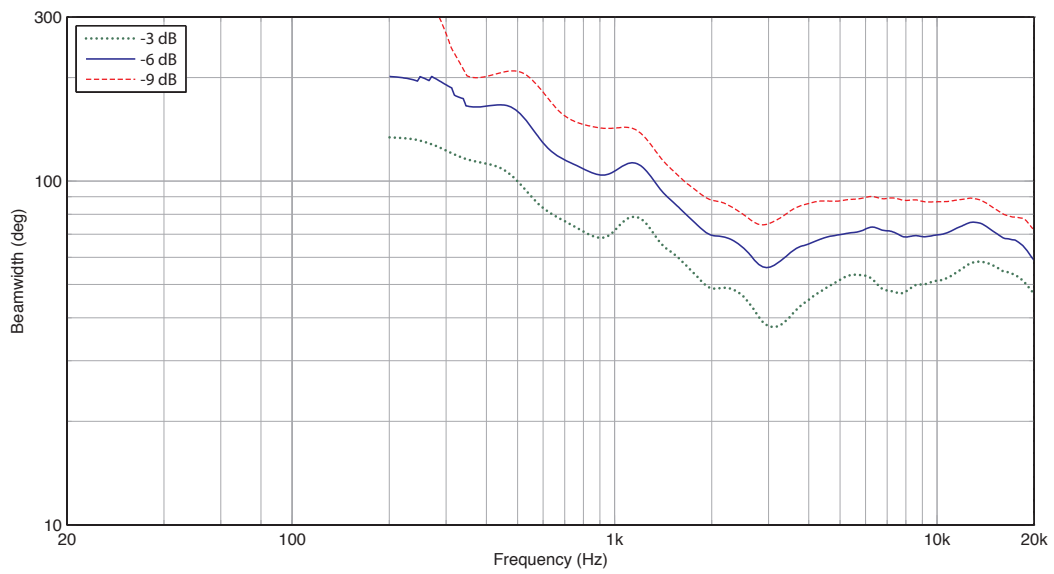

Vertical Beamwidth

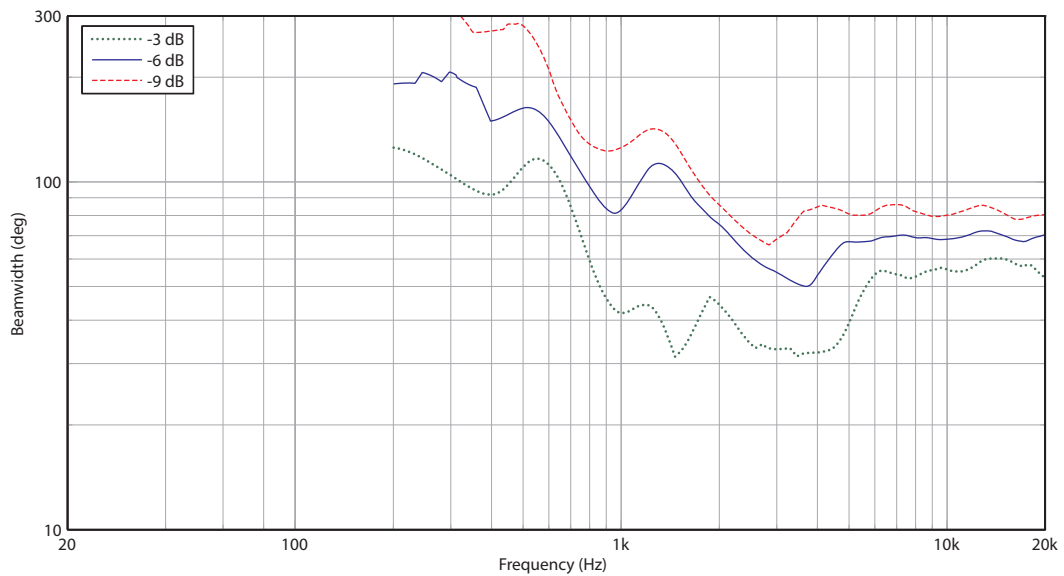

Portable Speakers

NuQ122

2 Way 12" Full Range Loudspeaker for
Portable PA and Installation Applications

Horizontal Polar Plots

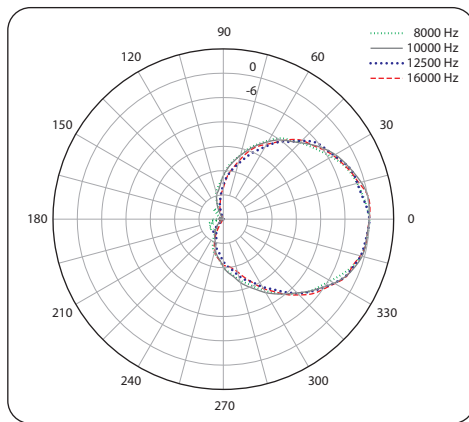
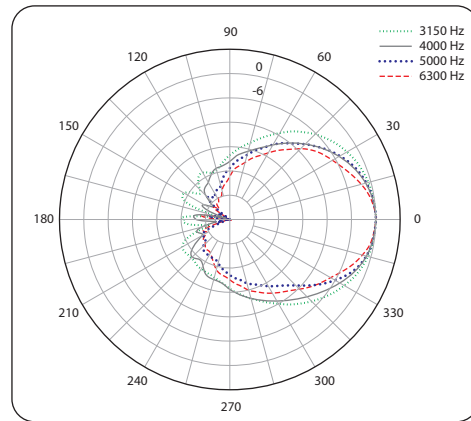
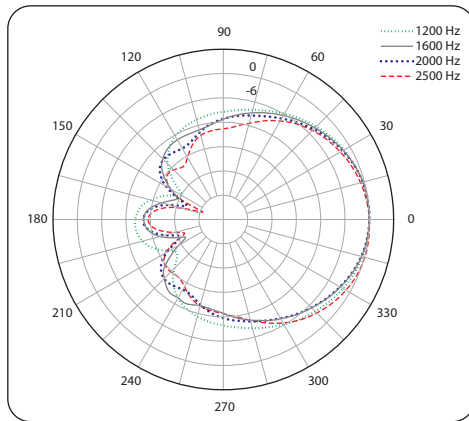
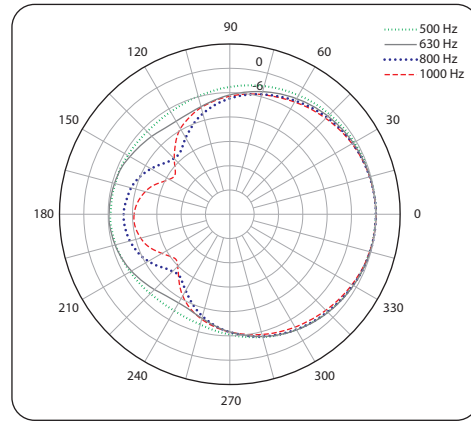
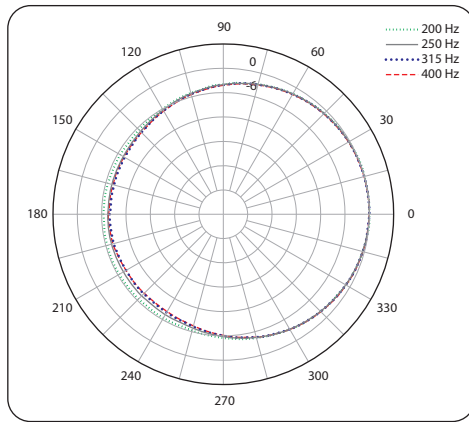

Portable Speakers

NuQ122

2 Way 12" Full Range Loudspeaker for
Portable PA and Installation Applications

Vertical Polar Plots

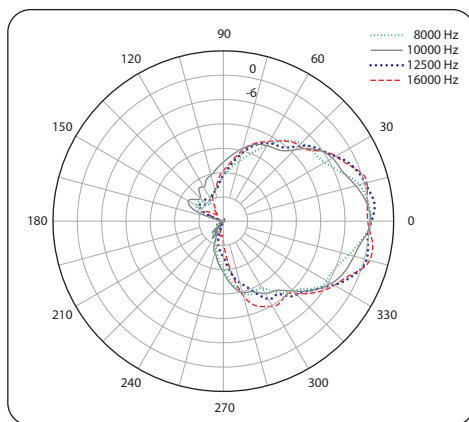
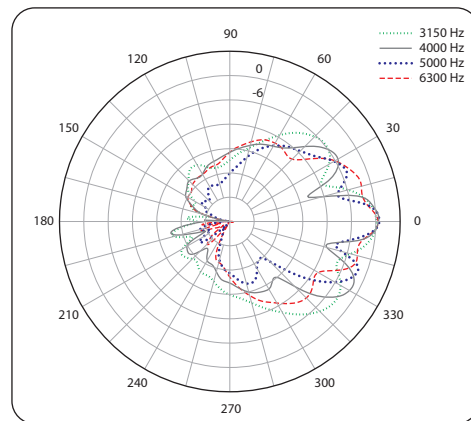
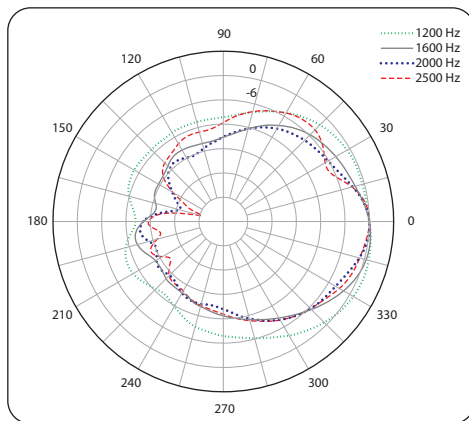
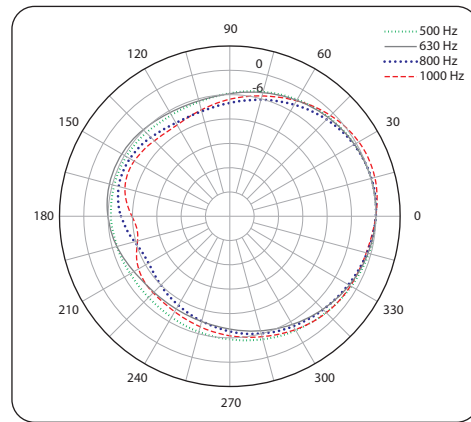
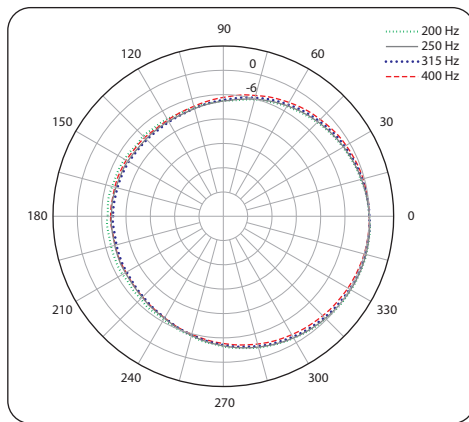

Portable Speakers

NuQ122

2 Way 12" Full Range Loudspeaker for Portable PA and Installation Applications

Dimensions

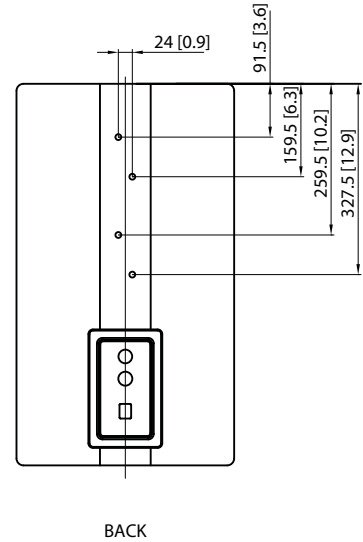
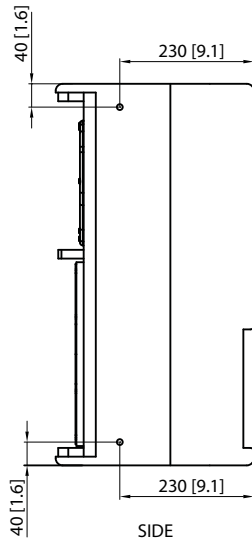
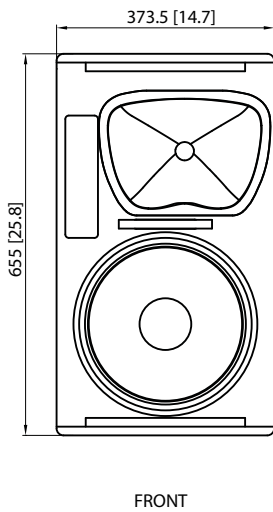
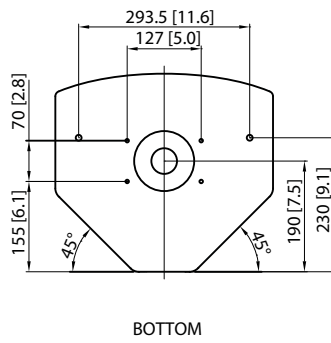
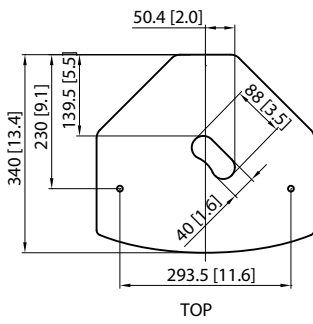

Portable Speakers

NuQ122

2 Way 12" Full Range Loudspeaker for
Portable PA and Installation Applications

Mounting and Rigging

The cabinet is fitted with M10 x 12 and M6 x 4 internally-threaded rigging points that allow it to be rigged with optional shoulder eyebolts and mounted in many different configurations in permanent installations. The simplest method of rigging is to use the two M10 rigging points on the top, and a single pull-back rigging point in the centre of the rear panel. Adjustment of the length of the rear cable allows the cabinet to be angled for optimum room coverage. Cabinets may also be hung upside down if required.

The cabinet has an integral 35 mm pole mount socket in the bottom panel, that allows it to be pole mounted. The cabinet is compatible with **TURBOSOUND** brackets, and industry standard brackets.

The optional **NuQ122-FY** fly yoke adds further installation flexibility for scaffold, surface, and pole mounting.

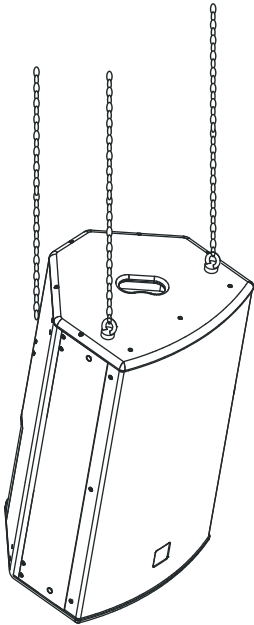

Suspension using M10
shoulder eyebolts.

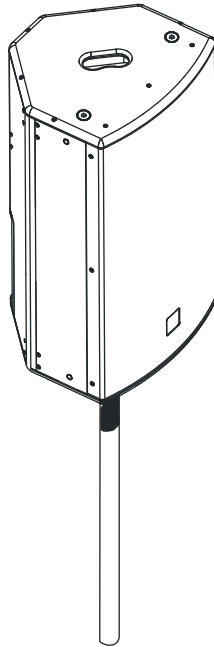

Mounting on 35 mm
pole or speaker stand

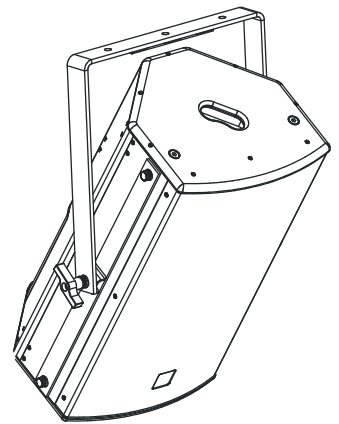

NuQ122-FY fly yoke.

Portable Speakers

NuQ122

2 Way 12" Full Range Loudspeaker for
Portable PA and Installation Applications

Technical Specifications

System

| | |
|-------------------------------|--|
| Frequency Response | 55 Hz – 18 kHz \pm 3 dB 50 Hz – 20 kHz -10 dB |
| Nominal Dispersion | 70° H x 70° V @ -6 dB points |
| Directivity Factor (Q) | 9.4 |
| Directivity Index (DI) | 9.7 |
| Power Handling (IEC) | |
| Passive | 400 W continuous, 1,600 W peak |
| Bi-amp | LF: 400 W continuous, 1,600 W peak HF: 40 W continuous, 160 W peak |
| Sensitivity | 96 dB (1 W @ 1 m) |
| Maximum SPL | |
| Passive | 122 dB continuous, 128 dB peak |
| Bi-Amp | LF: 122 dB continuous, 128 dB peak HF: 122 dB continuous, 128 dB peak |
| Impedance | |
| Passive | 8 Ω |
| Bi-Amp | LF: 8 Ω HF: 6 Ω |
| Crossover Type | Passive / bi-amp switchable |
| Components | 1 x 12" (316 mm) LF driver 1 x 1" (25 mm) HF compression driver |

Enclosure

| | |
|-------------------------------|--|
| Connectors | 2 x Neutrik speakON NL4 |
| Wiring | |
| Passive | Pins 1+ / 1- input, pins 2+ / 2- link |
| Bi-Amp | Pins 1+ / 1- LF, pins 2+ / 2- HF |
| Dimensions (H x W x D) | 655 x 373.5 x 340 mm (25.8 x 14.7 x 13.4") |
| Net Weight | 19.6 kg (43.1 lbs) |
| Construction | 15 mm (5/8") birch plywood |
| Finish | Semi matt black paint |
| Grille | Powder coated perforated steel |
| Flying Hardware | M10 x 12 points |

Accessories

NuQ122-FY

NuQ122

2 Way 12" Full Range Loudspeaker for
Portable PA and Installation Applications

Architecture & Engineering Specifications

The speaker shall be of the full range, two-way switchable bi-amp/passive type consisting of one 12" (316 mm) LF driver and one 1" (25 mm) HF compression driver. Performance specifications of a typical production unit shall meet or exceed the following: frequency response, measured with swept sine wave input, shall be flat within ± 3 dB from 55 Hz to 18 kHz and within -10 dB from 50 Hz to 20 kHz. Nominal dispersion, at -6 dB points, shall average 70° H x 70° V. Nominal impedance shall be HF: 6 Ohms, LF: 8 Ohms; passive: 8 Ohms. Power handling shall be HF: 40 Watts continuous, 160 Watts peak, LF: 400 Watts continuous, 1,600 Watts peak; passive: 400 Watts continuous, 1,600 Watts peak. Sensitivity, measured on axis, mean averaged over stated bandwidth, shall be 96 dB, 1 Watt @ 1 metre. Maximum SPL (peak), measured at 1 metre with music program at stated amplifier input, shall be HF: 128 dB, LF: 128 dB; passive: 128 dB. Dimensions: 655 mm high x 373.5 mm wide x 340 mm deep (25.8" x 14.7" x 13.4"). Net weight: 19.6 kg (43.1 lbs). The loudspeaker system shall be the **TURBOSOUND** NuQ122. No other loudspeaker shall be acceptable unless submitted data from an independent test laboratory verifies that the above combined performance / size specifications are equaled or exceeded.

Portable Speakers

NuQ122

2 Way 12" Full Range Loudspeaker for
Portable PA and Installation Applications

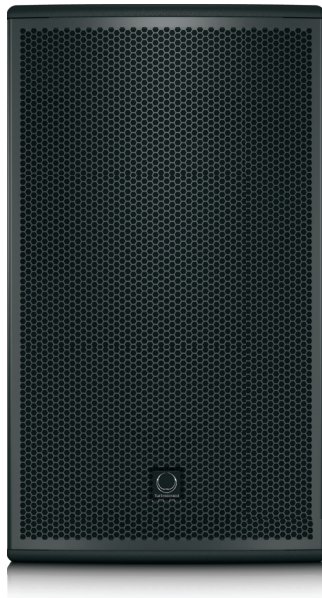

Portable Speakers

NuQ122

2 Way 12" Full Range Loudspeaker for
Portable PA and Installation Applications



Portable Speakers

NuQ122

2 Way 12" Full Range Loudspeaker for Portable PA and Installation Applications



For service, support or more information contact the TURBOSOUND location nearest you:

Europe
MUSIC Group Services UK
 Tel: +44 156 273 2290
 Email: CARE@music-group.com

USA/Canada
MUSIC Group Services NV Inc.
 Tel: +1 702 800 8290
 Email: CARE@music-group.com

Japan
MUSIC Group Services JP K.K.
 Tel: +81 3 6231 0454
 Email: CARE@music-group.com

MUSIC Group accepts no liability for any loss which may be suffered by any person who relies either wholly or in part upon any description, photograph, or statement contained herein. Technical specifications, appearances and other information are subject to change without notice. All trademarks are the property of their respective owners. MIDAS, KLARK TEKNIK, LAB GRUPPEN, LAKE, TANNOY, TURBOSOUND, TC ELECTRONIC, TC HELICON, BEHRINGER, BUGERA and DDA are trademarks or registered trademarks of MUSIC Group IP Ltd.
 © MUSIC Group IP Ltd. 2016 All rights reserved.

