

Portable Speakers

NuQ82

2 Way 8" Full Range Loudspeaker for Portable PA and Installation Applications

- 2 way full range loudspeaker for portable PA and installation applications
- 250 Watts continuous, 1,000 Watts peak power
- Ideal for FOH, side fill and monitor applications
- 8" low frequency driver with low mass voice coil for improved transient response
- Aluminium dome 1" neodymium motor compression driver
- Switchable passive/bi-amp operation for flexibility of use
- Rotatable converging elliptical waveguide provides 100° H x 60° V dispersion
- 12 mm (½") birch plywood enclosure with hard wearing semi matt black paint finish
- Rugged powder coated perforated steel mesh grille
- Integral 35 mm pole mount and handles
- Multiple internal rigging points allow bracket mount and suspension in any orientation
- Neutrik speakON* NL4 connectors for reliable long life operation
- 3-Year Warranty Program*
- Designed and engineered in England

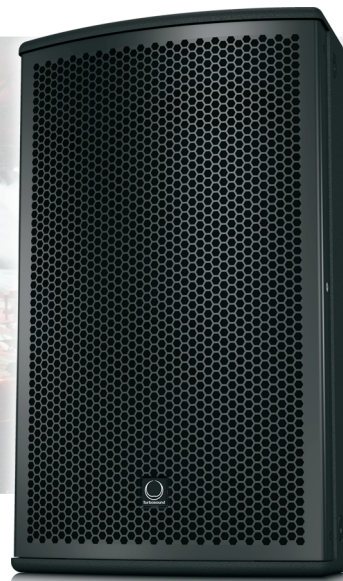

The 2-way full range NuQ82 is a switchable passive/bi-amp 1,000 Watt 8" loudspeaker system ideally suited for a wide range of speech and music sound reinforcement applications. Engineered to work in conjunction with **TURBOSOUND** loudspeaker management systems, the NuQ82 provides optimal performance for FOH, sidefill and delay line loudspeakers, and is an exceptional choice for wedge monitoring applications.



The NuQ82 loudspeaker features an 8" low frequency driver with a low mass voice coil for improved transient response, and an aluminium dome 1" neodymium high frequency compression driver mounted on a rotatable 100° horizontal by 60° vertical dispersion converging elliptical waveguide. All drivers are matched with an internal passive crossover network in a reflex-loaded enclosure, and bi-amp mode can be enabled by means of a rear panel switch. The rear panel connector plate carries Neutrik speakON* NL4 connectors for input and link connections to additional enclosures.

Finished in a highly durable semi matt black paint, the cabinet is constructed from 12 mm (½") birch plywood – and includes a rugged powder coated perforated steel mesh grille backed with reticulated foam. Multiple threaded rigging points are provided for suspension in any orientation, or for mounting with industry standard wall brackets. Optional flying yoke, swivel brackets, and swivel extenders allow for further flexibility in install applications (each available separately). The NuQ82 also features a 35 mm socket for standard pole mounting – plus integrated handles for convenient transport.

Portable Speakers

NuQ82

2 Way 8" Full Range Loudspeaker for
Portable PA and Installation Applications



You Are Covered

We always strive to provide the best possible Customer Experience. Our products are made in our own [MUSIC Group](#) factory using state-of-the-art automation, enhanced production workflows and quality assurance labs with the most sophisticated test equipment available in the world. As a result, we have one of the lowest product failure rates in the industry, and we confidently back it up with a generous [3-Year Warranty program](#).

Portable Speakers

NuQ82

2 Way 8" Full Range Loudspeaker for Portable PA and Installation Applications

Frequency Response Sensitivity 1 W / 1 m

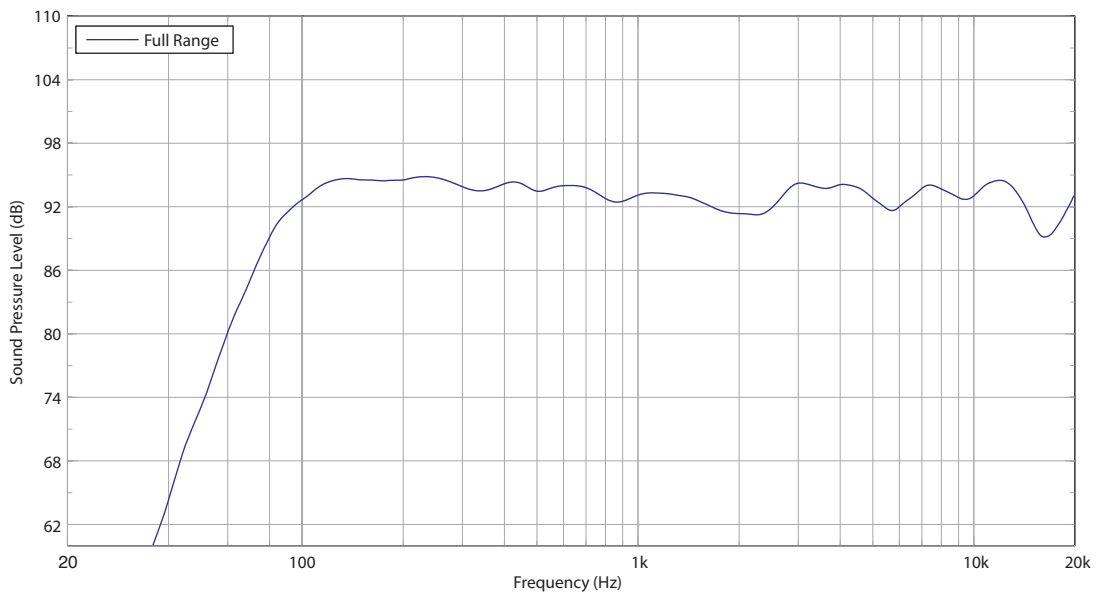

Impedance

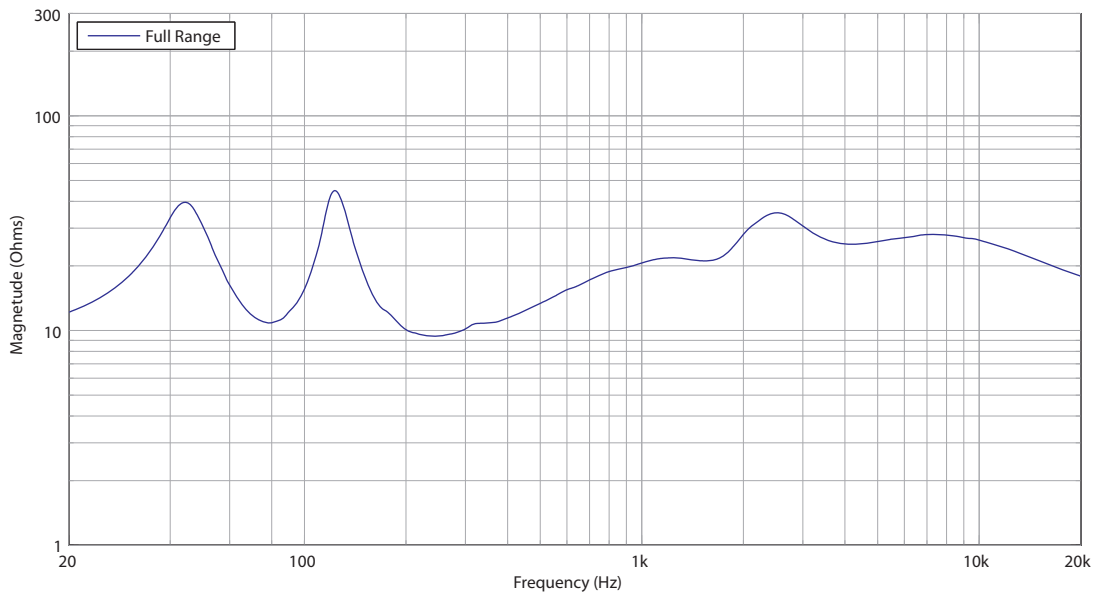

Portable Speakers

NuQ82

2 Way 8" Full Range Loudspeaker for Portable PA and Installation Applications

Horizontal Beamwidth

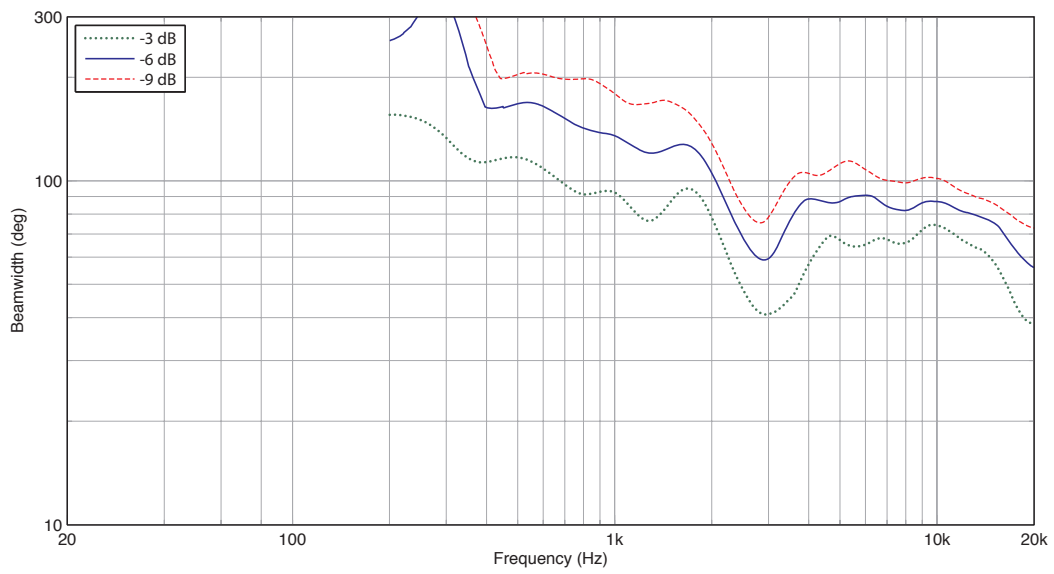

Vertical Beamwidth

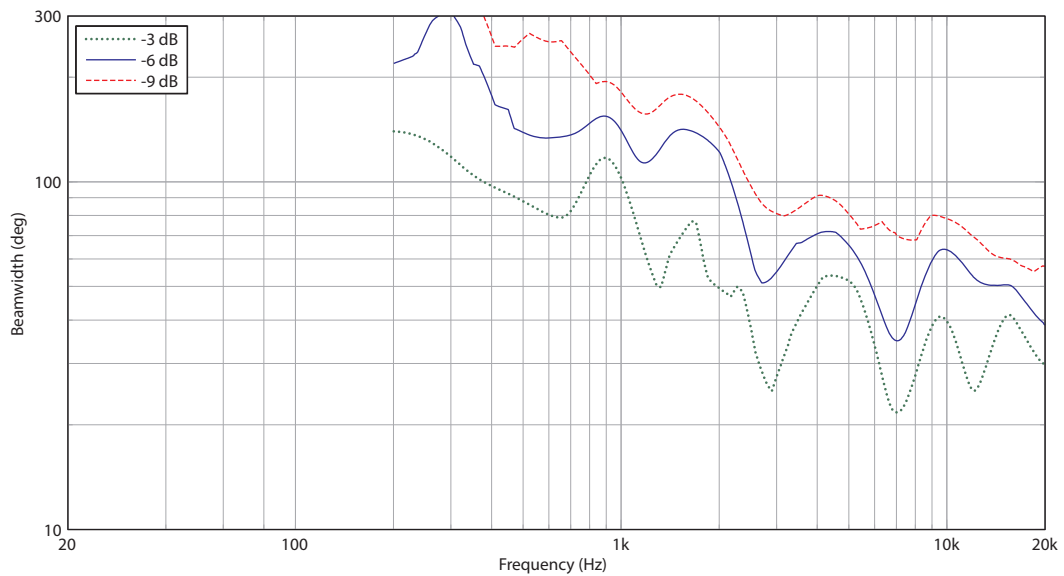

Portable Speakers

NuQ82

2 Way 8" Full Range Loudspeaker for Portable PA and Installation Applications

Horizontal Polar Plots

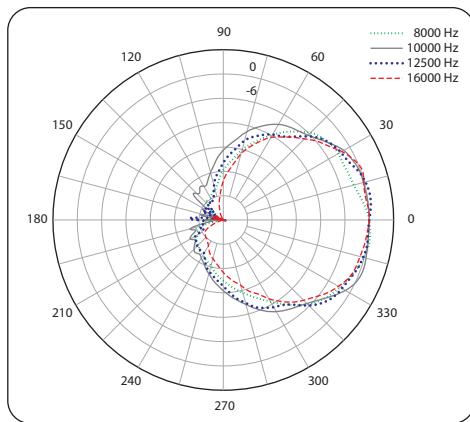
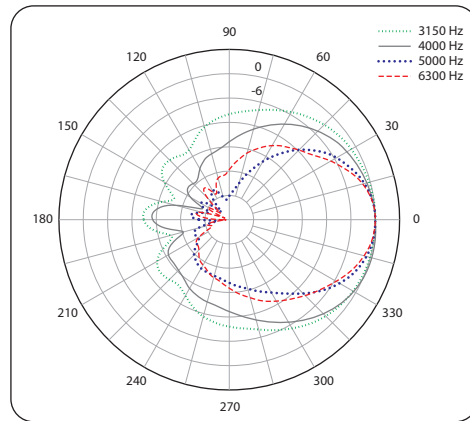
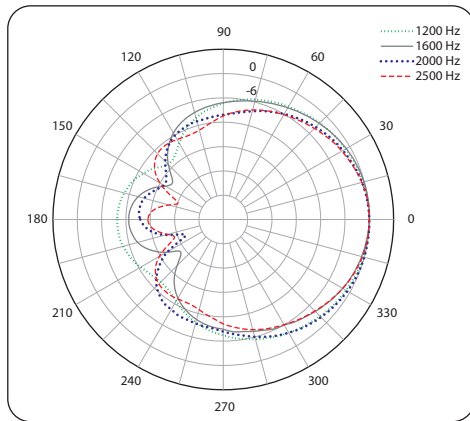
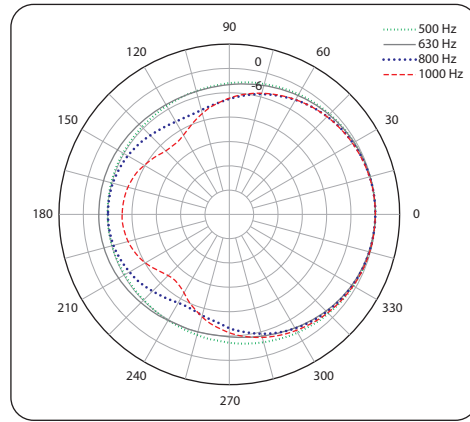
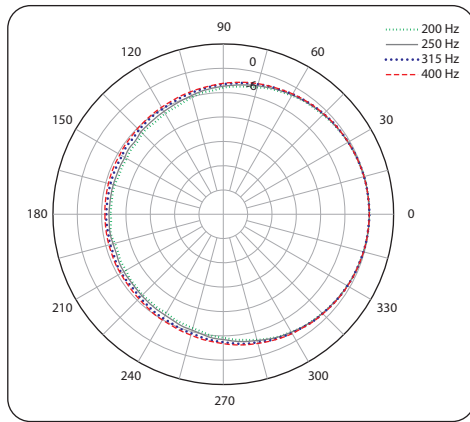

Portable Speakers

NuQ82

2 Way 8" Full Range Loudspeaker for
Portable PA and Installation Applications

Vertical Polar Plots

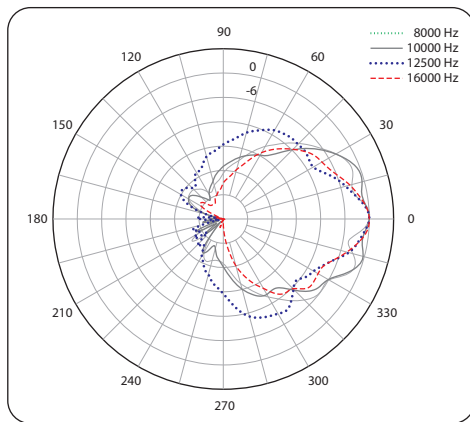
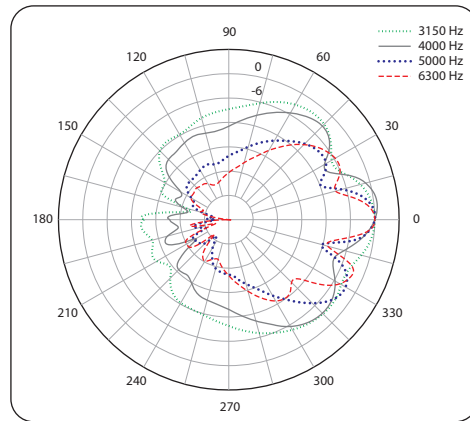
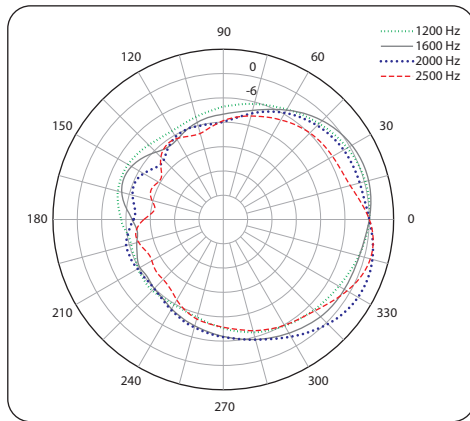
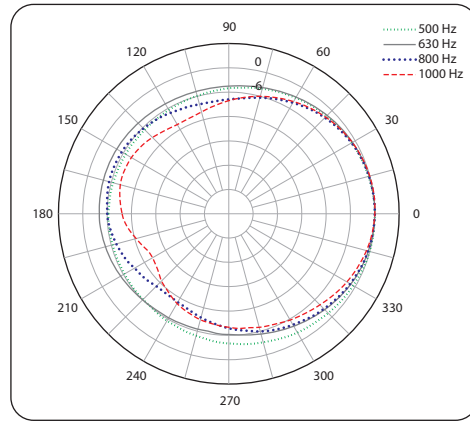
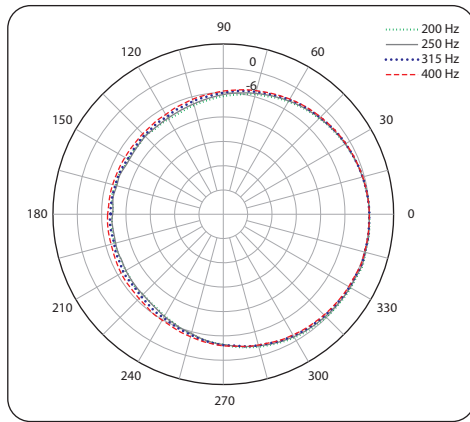

Portable Speakers

NuQ82

2 Way 8" Full Range Loudspeaker for
Portable PA and Installation Applications

Dimensions

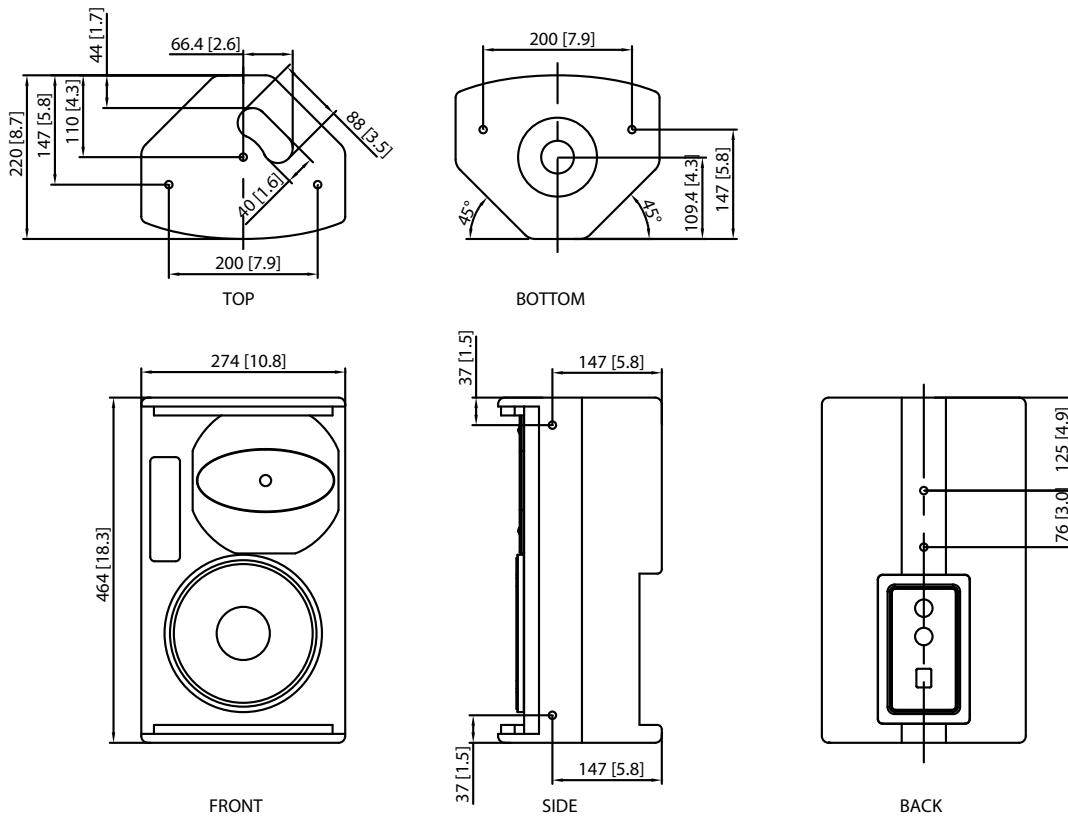

Portable Speakers

NuQ82

2 Way 8" Full Range Loudspeaker for
Portable PA and Installation Applications

Mounting and Rigging

The cabinet is fitted with M10 x 8 and M8 x 3 internally-threaded rigging points that allow it to be rigged with optional shoulder eyebolts and mounted in many different configurations in permanent installations. The simplest method of rigging is to use the two M10 rigging points on the top, and a single pull-back rigging point in the centre of the rear panel. Adjustment of the length of the rear cable allows the cabinet to be angled for optimum room coverage. Cabinets may also be hung upside down if required.

The cabinet has an integral 35 mm pole mount socket in the bottom panel, that allows it to be pole mounted. The cabinet is compatible with **TURBOSOUND** brackets, and industry standard brackets.

The optional **NuQ82-SB** swivel bracket allows the cabinet to be surface mounted and angled for optimum positioning and coverage. The **NuQ82-EB** extender bracket allows cabinets to be arrayed, and the **NuQ82-FY** fly yoke adds further installation flexibility for scaffold, surface, and pole mounting.

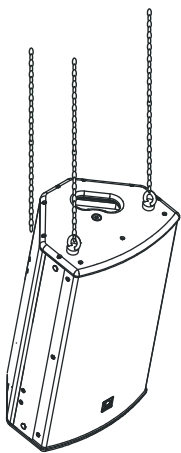

Suspension using M10
shoulder eyebolts

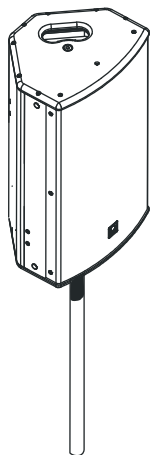

Mounting on 35 mm
pole or speaker stand

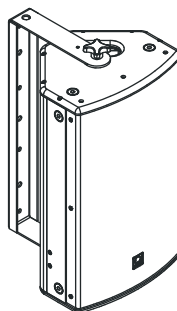

NuQ82-SB swivel
bracket for surface
mounting

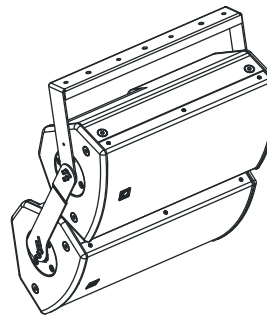

NuQ82-SB bracket
with NuQ82-EB
extender brackets,
creating an array

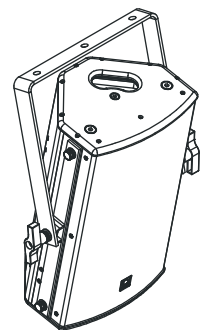

NuQ82-FY fly yoke

Portable Speakers

NuQ82

2 Way 8" Full Range Loudspeaker for
Portable PA and Installation Applications

Technical Specifications

System

Frequency Response	65 Hz – 18 kHz ± 3 dB 55 Hz - 20 kHz -10 dB
Nominal Dispersion	100° H x 60° V @ -6 dB points, rotatable
Directivity Factor (Q)	8
Directivity Index (DI)	9
Power Handling (IEC)	
Passive	250 W continuous, 1,000 W peak
Bi-amp	LF: 250 W continuous, 1,000 W peak HF: 30 W continuous, 120 W peak
Sensitivity	93 dB (1 W @ 1 m)
Maximum SPL	
Passive	117 dB continuous, 123 dB peak
Bi-Amp	LF: 117 dB continuous, 123 dB peak HF: 119 dB continuous, 125 dB peak
Impedance	
Passive	8 Ω
Bi-Amp	LF: 8 Ω HF: 6 Ω
Crossover Type	Passive / Bi-amp switchable
Components	1 x 8" (211 mm) LF Driver 1 x 1" (25 mm) HF Compression Driver

Enclosure

Connectors	2 x Neutrik speakON* NL4
Wiring	
Passive	Pins 1+ / 1- input, pins 2+ / 2- link
Bi-Amp	Pins 1+ / 1- LF, pins 2+ / 2- HF
Dimensions (H x W x D)	464 x 274 x 220 mm (18.3 x 10.7 x 8.7")
Net Weight	10.2 kg (22.4 lbs)
Construction	12 mm (½") birch plywood
Finish	Semi matt black paint
Grille	Powder-coated perforated steel
Flying Hardware	M10 x 8 points; M8 x 3 points

Accessories

NuQ82-SB
NuQ82-EB
NuQ82-FY

Portable Speakers

NuQ82

2 Way 8" Full Range Loudspeaker for
Portable PA and Installation Applications

Architecture & Engineering Specifications

The speaker shall be of the full range, two-way switchable bi-amp/passive type consisting of one 8" (211 mm) LF driver and one 1" (25 mm) HF compression driver. Performance specifications of a typical production unit shall meet or exceed the following: frequency response, measured with swept sine wave input, shall be flat within ± 3 dB from 65 Hz to 18 kHz and within -10 dB from 55 Hz to 20 kHz. Nominal dispersion, at -6 dB points, shall average 100° H x 60° V, rotatable. Nominal impedance shall be HF: 6 Ohms, LF: 8 Ohms; passive: 8 Ohms. Power handling shall be HF: 30 Watts continuous, 120 Watts peak, LF: 250 Watts continuous, 1,000 Watts peak; passive: 250 Watts continuous, 1,000 Watts peak. Sensitivity, measured on axis, mean averaged over stated bandwidth, shall be 93 dB, 1 Watt @ 1 metre. Maximum SPL (peak), measured at 1 metre with music program at stated amplifier input, shall be HF: 125 dB, LF: 123 dB; passive: 123 dB. Dimensions: 464 mm high x 274 mm wide x 220 mm deep (18.3" x 10.7" x 8.7"). Net weight: 10.2 kg (22.4 lbs). The loudspeaker system shall be the **TURBOSOUND** NuQ82. No other loudspeaker shall be acceptable unless submitted data from an independent test laboratory verifies that the above combined performance / size specifications are equaled or exceeded.

Portable Speakers

NuQ82

2 Way 8" Full Range Loudspeaker for
Portable PA and Installation Applications



Portable Speakers

NuQ82

2 Way 8" Full Range Loudspeaker for
Portable PA and Installation Applications



Portable Speakers

NuQ82

2 Way 8" Full Range Loudspeaker for Portable PA and Installation Applications



For service, support or more information contact the TURBOSOUND location nearest you:

Europe
MUSIC Group Services UK
Tel: +44 156 273 2290
Email: CARE@music-group.com

USA/Canada
MUSIC Group Services NV Inc.
Tel: +1 702 800 8290
Email: CARE@music-group.com

Japan
MUSIC Group Services JP K.K.
Tel: +81 3 6231 0454
Email: CARE@music-group.com

MUSIC Group accepts no liability for any loss which may be suffered by any person who relies either wholly or in part upon any description, photograph, or statement contained herein. Technical specifications, appearances and other information are subject to change without notice. All trademarks are the property of their respective owners. MIDAS, KLARK TEKNIK, LAB GRUPPEN, LAKE, TANNOY, TURBOSOUND, TC ELECTRONIC, TC HELICON, BEHRINGER, BUGERA and DDA are trademarks or registered trademarks of MUSIC Group IP Ltd.
© MUSIC Group IP Ltd. 2016 All rights reserved.

