



Prestel FMS-88H2AM

18Gbps 8x8 Seamless Matrix



USER MANUAL

Thank you for purchasing this product

For optimum performance and safety, please read these instructions carefully before connecting, operating or adjusting this product. Please keep this manual for future reference.

Surge protection device recommended

This product contains sensitive electrical components that may be damaged by electrical spikes, surges, electric shock, lightning strikes, etc. Use of surge protection systems is highly recommended in order to protect and extend the life of your equipment.

Caution

The product requires the use of UTP connectors. Please connect in direct interconnection method and do not cross connect.

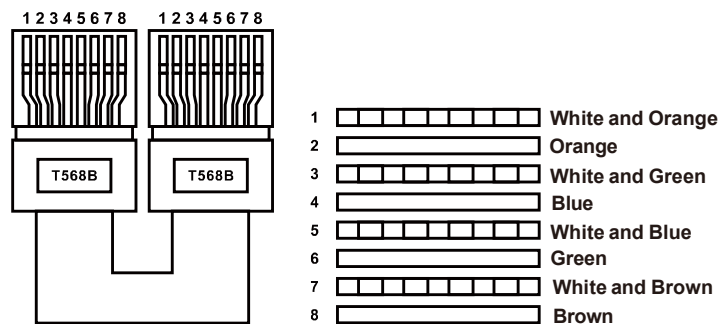

Direct Interconnection Method

Table of Contents

1. Introduction.....	1
2. Features.....	1
3. Package Contents.....	1
4. Specifications.....	2
5. Operation Controls and Functions.....	3
6. IR Remote.....	7
7. IR Cable Pin Assignment.....	8
8. EDID Management.....	9
9. Web GUI User Guide.....	11
10. RS-232 Control Command.....	23
11. Application Example.....	31

1. Introduction

The 18Gbps 8x8 Seamless Matrix is a perfect solution for video transmission from 8 HDMI sources to 8 HDTV displays. Video resolution is up to 4K@60Hz 4:4:4. Each output supports resolution downscaling individually. It features video wall function and built-in WEB server. It also has 8 routes L/R audio output channels to output balanced audio. And seamless switching ensures a smooth picture transition without frame loss.

This matrix can be controlled via front panel buttons, IR remote, RS-232 and Web GUI.

2. Features

- ☆ HDCP 2.2 compliant
- ☆ Support video resolution up to 4K@60Hz 4:4:4 and 18Gbps video bandwidth, as specified in HDMI 2.0b
- ☆ Support seamless switching
- ☆ Support 8 route L/R balanced audio output
- ☆ Each output supports horizontal mirror and vertical mirror
- ☆ Blank screen, blue screen and output off are optional when no signal outputs
- ☆ HDMI audio format: LPCM, Dolby Digital/Plus/EX, Dolby True HD, DTS, DTS-EX, DTS-96/24, DTS High Res, DTS-HD Master Audio
- ☆ Support CEC control, and multiple video resolution output
- ☆ Support power-off memory and advanced EDID management
- ☆ Control via front panel buttons, IR remote, RS-232, and Web GUI
- ☆ Compact design for easy and flexible installation, standard height of 1U

3. Package Contents

- ① 1 × 18Gbps 8x8 Seamless Matrix
- ② 1 × 24V/3.75A Locking Power Supply
- ③ 1 × IR Remote
- ④ 1 × IR Wideband Receiver Cable (1.5m)
- ⑤ 1 × USB to RS-232 Serial Cable (USB A to RS-232 serial DB9 male connector)
- ⑥ 8 × 5pin-3.5mm Phoenix Connector (male)
- ⑦ 8 × Machine Screw
- ⑧ 2 × Mounting Ear
- ⑨ 1 × User Manual

4. Specifications

Technical			
HDMI Compliance	HDMI 2.0b		
HDCP Compliance	HDCP 2.2		
Video Bandwidth	594MHz/18Gbps		
Video Resolution	Up to 4K@60Hz 4:4:4		
Color Space	RGB, YCbCr 4:4:4 / 4:2:2. YUV 4:2:0		
Color Depth	8/10/12bit		
Audio Formats	HDMI IN/OUT: LPCM, Dolby Digital/Plus/EX, Dolby True HD, Dolby Atmos, DTS, DTS-EX, DTS-96/24, DTS High Res, DTS-HD Master Audio, DSD AUDIO Extracted: Optical Outputs: LPCM 2.0CH/Dolby/DTS 5.1CH Balanced Analog Audio Outputs: LPCM 2CH		
IR Level	5Vp-p		
IR Frequency	Wideband 20K-60KHz		
ESD Protection	IEC 61000-4-2: ±8kV (Air-gap discharge) & ±4kV (Contact discharge)		
Connection			
Input ports	8 × HDMI INPUT [Type A, 19-pin female]		
Output ports	8 × HDMI OUTPUT [Type A, 19-pin female] 8 × OPTICAL AUDIO OUT [S/PDIF] 8 × L/R AUDIO OUT [3.5mm, 5pin Phoenix Connector]		
Control ports	1 × TCP/IP [RJ45] 1 × RS-232 [D-Sub 9] 1 × IR EXT [3.5mm, Stereo Mini-jack]		
Mechanical			
Housing	Metal Enclosure		
Color	Black		
Dimensions	440mm [W] × 300mm [D] × 44.5mm [H]		
Weight	3.95kg		
Power Supply	Input: AC 100-240V 50/60Hz, Output: DC 24V/3.75A (US/EU standard, CE/FCC/UL certified)		
Power Consumption	70W (Max)		
Operating Temperature	32 - 104°F / 0 - 40°C		
Storage Temperature	-4 - 140°F / -20 - 60°C		
Relative Humidity	20 - 90% RH (no-condensing)		
Video Resolution	4K60	4K30	1080P60
HDMI Cable Length (HDMI IN / OUT)	5m/16ft	10m/32ft	15m/50ft
The use of "Premium High Speed HDMI" cable is highly recommended.			

5. Operation Controls and Functions

5.1 Front Panel

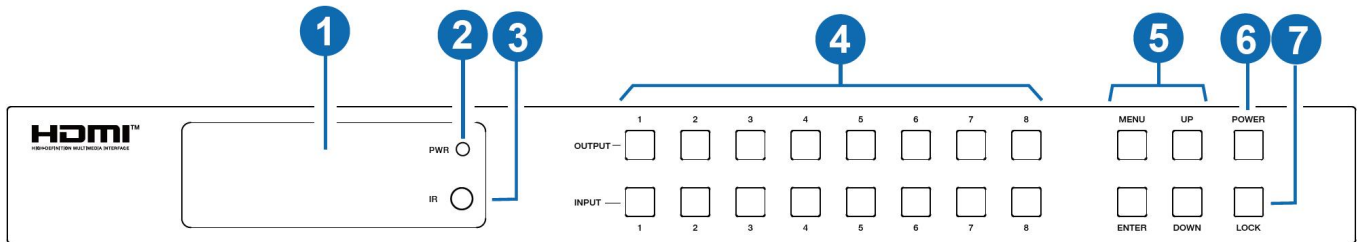

NO.	Name	Function Description
1	OLED screen	Display matrix switching status, input/output port, EDID, baud rate, IP address, etc.
2	PWR LED	The LED is on green when the device is working. The LED is on red when the device is on standby.
3	IR	IR signal receiver, receiving the signal from the IR remote.
4	INPUT / OUTPUT buttons	You need to press an output button (1~8) firstly and then press an input button (1~8) to select the corresponding input source for the output port.
5	MENU / ENTER / UP / DOWN	<p>Take RESET, for example.</p> <ol style="list-style-type: none"> ① On the initial OLED display screen, press "MENU" button. There are OUTPUT/ INPUT/EXTAUDIO/SETUP items to be selected. ② Press the "UP/DOWN" button to select "SETUP" item. ③ Press the "ENTER" button to enter into the next level menu. There are LCD ONTIME/BAUD RATE/IP INFO/REBOOT/RESET items to be selected. ④ Press the "UP/DOWN" button to select "RESET" item. ⑤ Press the "ENTER" button to confirm the selection. ⑥ Press the "ENTER" button, and then it will prompt: SUCCESS! <p>Note:</p> <ul style="list-style-type: none"> • Pressing the "MENU" button will return to the previous menu. • In any level menu, it will return to the initial screen if no operation goes on within 10 seconds.
6	POWER button	Long press the button for 3 second to enter the standby mode, then short press it to wake up the device.
7	LOCK button	Short press the button to lock front panel buttons (Except the power button); press it again to unlock.

5.2 Rear Panel

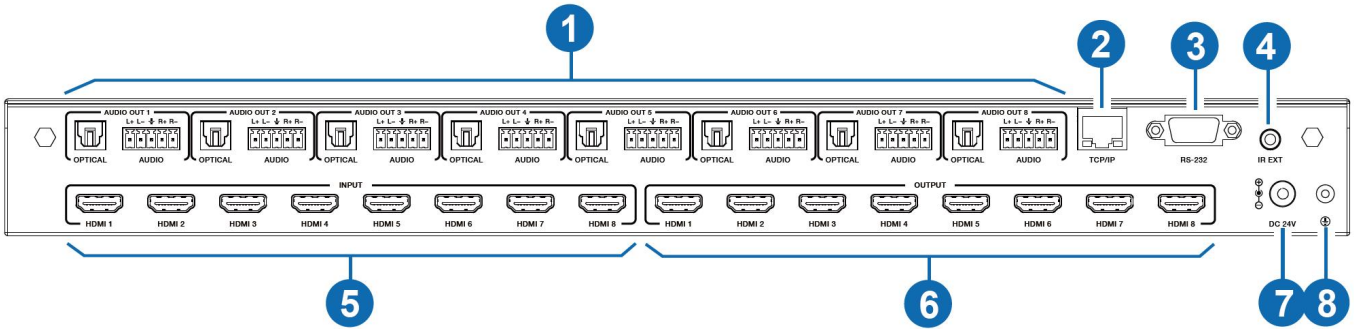

NO.	Name	Function Description
1	AUDIO OUT (1~8)	<p>OPTICAL: Optical audio output port, connected to an audio output device such as audio amplifier.</p> <p>L/R AUDIO: Analog audio output port, supporting balanced audio output (with a maximum support of 2Vrms) and unbalanced audio output.</p> <p>Balanced audio connection method: L+, L-, $\frac{\perp}{\perp}$, R+, R-</p> <p>Unbalanced audio connection method: L+, $\frac{\perp}{\perp}$, R+</p>
2	TCP/IP	TCP/IP control port, connected to a PC or router with CAT cable.
3	RS-232 port	Connect to a PC or control system by D-Sub 9-pin cable to transmit RS-232 commands.
4	IR EXT	<p>IR signal receiving port.</p> <p>If the IR receiver window of the unit is blocked or the unit is installed in a closed area out of infrared line of sight, the IR receiver cable can be connected to the “IR EXT” port to receive the IR remote signal.</p>
5	HDMI INPUT ports (1~8)	HDMI input ports, connected to HDMI source devices such as Blu-ray player or PC with an HDMI cable.
6	HDMI OUTPUT ports (1~8)	HDMI output ports, connected to HDMI display devices such as TV, monitor or projector with an HDMI cable.
7	DC 24V	Connect to 24V/3.75A power supply.
8	GND	Connect the housing to the ground.

Note:

1. You can restore the factory settings via the front panel, Web GUI or RS-232 command.
2. Power cut memory function is available except for standby status and panel lock.
3. The RS-232 and Web will be available in a few minutes when the device is powered on.

5.3 LCD Display Navigation

The buttons on the the front panel are used for LCD display navigation, including INPUT(1~8), OUTPUT(1~8), MENU, ENTER, UP, DOWN.

Menu items are as follows:

Level 1	Level 2	Level 3	Level 4
OUTPUT	RESO	OUT1 / OUT2 / OUT3 / OUT4 / OUT5 / OUT6 / OUT7 / OUT8	4K×2K60W, 4K×2K50W, 4K×2K60, 4K×2K50, 4K×2K30, 1080P60, 1080P50, 1080i60, 1080i50, 1920×1200P60RB, 1360×768P60, 1280×800P60, 720P60, 720P50, XGA60, AUTO
	CSC	OUT1 / OUT2 / OUT3 / OUT4 / OUT5 / OUT6 / OUT7 / OUT8	RGB 444 YUV 444 YUV 422 YUV 420
	STREAM	OUT1 / OUT2 / OUT3 / OUT4 / OUT5 / OUT6 / OUT7 / OUT8	ENABLE DISABLE
	MIRROR	OUT1 / OUT2 / OUT3 / OUT4 / OUT5 / OUT6 / OUT7 / OUT8	OFF H MIRROR V MIRROR HV MIRROR

Level 1	Level 2	Level 3	Level 4
INPUT	EDID	IN1 / IN2 / IN3 / IN4 / IN5 / IN6 / IN7 / IN8	4K60, 2.0CH 4K60, 5.1CH 4K60, 7.1CH 4K30, 2.0CH 4K30, 5.1CH 4K30, 7.1CH 1080P, 2.0CH 1080P, 5.1CH 1080P, 7.1CH 1920×1200, 2.0CH 1360×768, 2.0CH 1024×768, 2.0CH USER1 USER2 COPY OUT1 COPY OUT2 COPY OUT3 COPY OUT4 COPY OUT5 COPY OUT6 COPY OUT7 COPY OUT8
EXTAUDIO	OUT	OUT1 / OUT2 / OUT3 / OUT4 / OUT5 / OUT6 / OUT7 / OUT8	ENABLE DISABLE
	MODE	BIND TO INPUT / BIND TO OUTPUT / AUDIO MATRIX	/
	MATRIX	OUT1 / OUT2 / OUT3 / OUT4 / OUT5 / OUT6 / OUT7 / OUT8	INPUT1 INPUT2 INPUT3 INPUT4 INPUT5 INPUT6 INPUT7 INPUT8
SETUP	LCD ONTIME	OFF / ALWAYS ON / 15 SECONDS / 30 SECONDS / 60 SECONDS	/
	BAUD RATE	4800 / 9600 / 19200 / 38400 / 57600 / 115200	/
	IP INFO	DHCP:ON / OFF	/
	REBOOT	/	/
	RESET	/	/

6. IR Remote

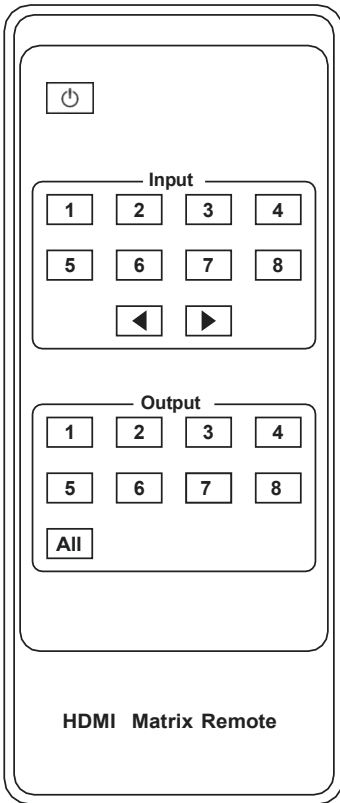

Power on or Standby:

Power on the Matrix or set it to standby mode.

Input 1/2/3/4/5/6/7/8:

Press these buttons to select the input source.



Select the last or next input source.

Output 1/2/3/4/5/6/7/8:

Press these buttons to select the output display device.

All:

Select all output channels simultaneously. For example, when you press the “All” button and then press input “1” button, at this time the input “1” source will be output to all display devices.

Operation Instruction:

You need to press the output button firstly and then press input button to select the corresponding input source. For example, press Output-X (X means output button from 1 to 8 , including “All” button), then press Input-Y (Y means input button from 1 to 8)

The Matrix can be selected input and output source by using the IR remote. There are two ways to receive the IR remote signal.

The first way: The IR window accepts the IR remote signal. Using the IR remote, the furthest distance is 8 meters when the IR remote is directly faced to the matrix, and 5 meters when the using angle is $\pm 45^\circ$. The diagram is shown as below:

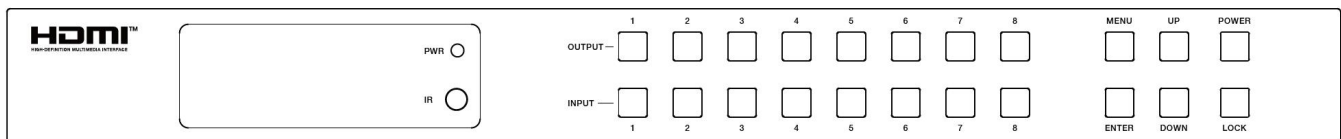

IR remote of the Matrix

The second way: If the IR receiver window of the Matrix is blocked or the Matrix is installed in a closed area out of infrared line of sight, the IR receiver cable can be inserted to the “IR EXT” port to receive the IR remote signal. The furthest distance of using the IR remote is 5 meters when the IR remote is directly faced to the IR receiver head, and 3 meters when the using angle is $\pm 45^\circ$. The diagram is shown as below.

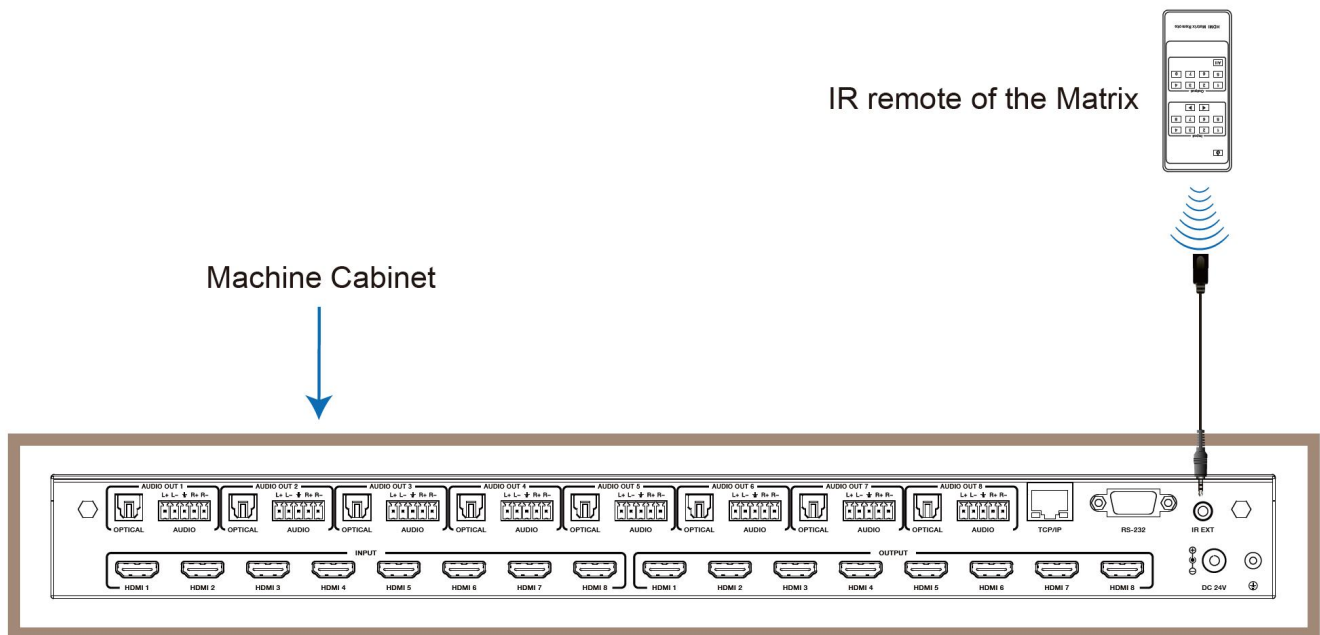

7. IR Cable Pin Assignment

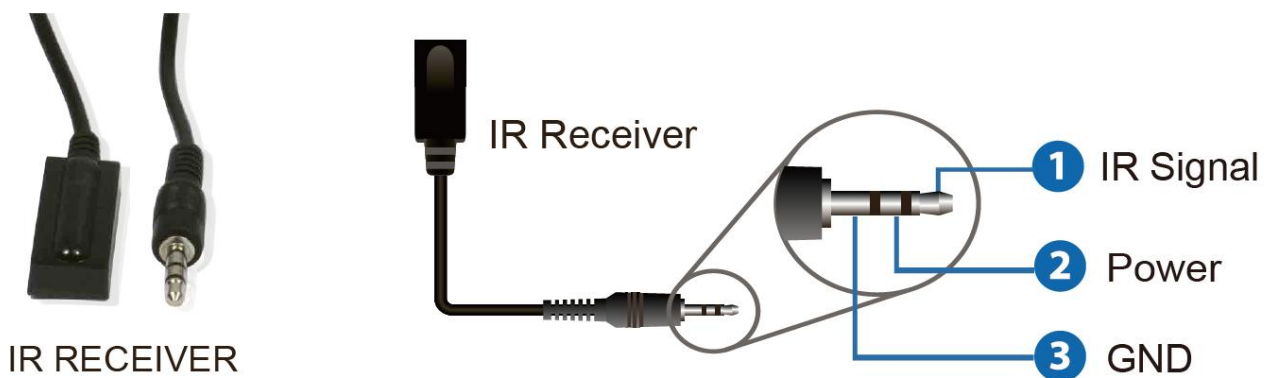

8. EDID Management

This Matrix has 12 factory defined EDID settings, 2 user-defined EDID modes and 8 copy EDID modes. You can select defined EDID mode or copy EDID mode to input port through front panel buttons, RS-232 control or Web GUI.

On-panel button operation: On the initial OLED display screen, press “MENU” button to enter the first level menu, press “UP/DOWN” button to select "INPUT", and then press the “ENTER” button. Now the "EDID" item appears. Press the “ENTER” button, and then press “UP/DOWN” button to select the EDID mode you need. Then press “ENTER” button to confirm this operation.

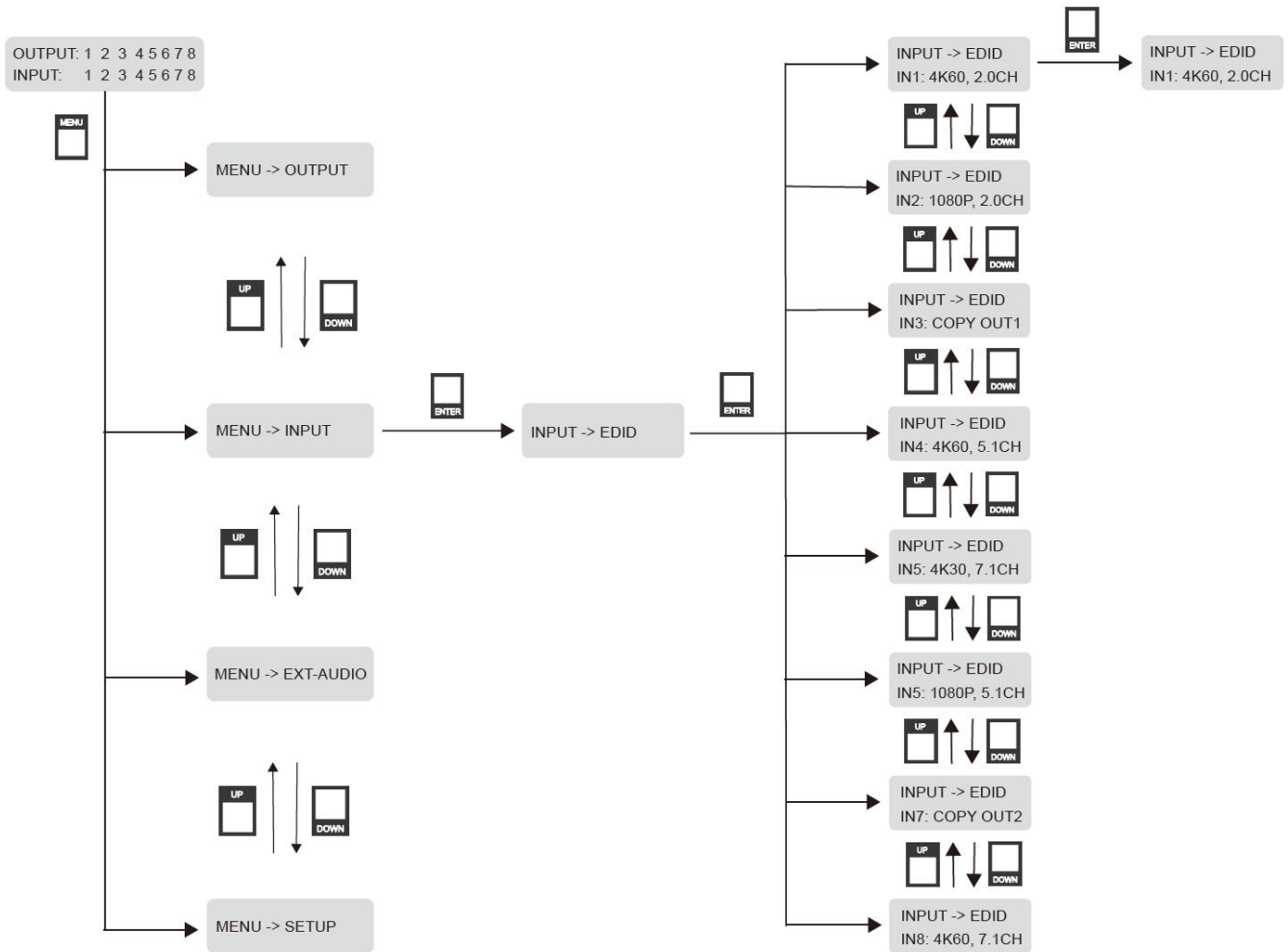

Note: Pressing the “MENU” button will return to the previous menu.

RS-232 control operation: Connect the Matrix to PC with a serial cable, then open a Serial Command tool on PC to send ASCII command “s input x EDID z!” to set EDID. For details, please refer to “EDID Setting” in the ASCII command list of “10. RS-232 Control Command”.

Web GUI Operation: Please check the EDID management in the “Input page” of “9. Web GUI User Guide”.

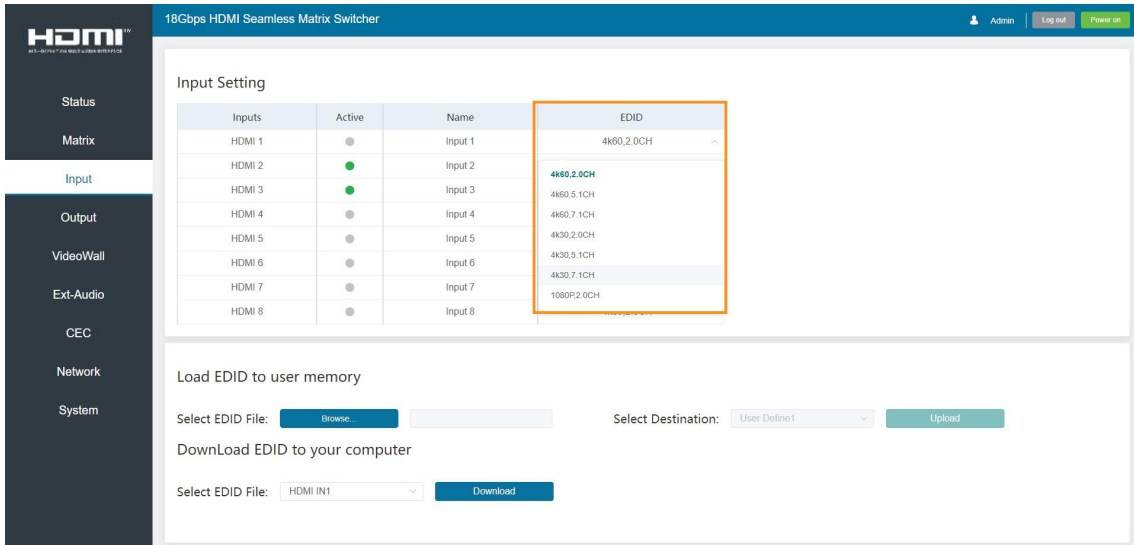

The defined EDID setting list of the product is shown as below:

No.	EDID Mode
1	4K60, 2.0CH
2	4K60, 5.1CH
3	4K60, 7.1CH
4	4K30, 2.0CH
5	4K30, 5.1CH
6	4K30, 7.1CH
7	1080P, 2.0CH
8	1080P, 5.1CH
9	1080P, 7.1CH
10	1920×1200, 2.0CH
11	1360×768, 2.0CH
12	1024×768, 2.0CH
13	USER1
14	USER2
15	COPY OUT1
16	COPY OUT2
17	COPY OUT3
18	COPY OUT4
19	COPY OUT5
20	COPY OUT6
21	COPY OUT7
22	COPY OUT8

9. Web GUI User Guide

The Matrix can be controlled by Web GUI. The operation method is shown as below:

Step 1: Get the current IP Address.

The default IP address is 192.168.0.100. You can get the current Matrix IP address in two ways:

The first way: You can get the IP address via the front panel buttons. On the initial OLED display screen, press "MENU" to enter the first level menu, press "UP/DOWN" to select "SETUP", and then press "ENTER" to enter the second level menu. Press "UP/DOWN" to select "IP INFO", and press "ENTER" button to check the IP.

The second way: You can get the IP address via RS-232 control. Send the command "r ip addr!" through an ASCII Command tool, and then you'll get the feedback information as shown below:

IP: 192.168.0.100

IP:192.168.0.100 in the above figure is the IP Address of the Matrix (the IP address is variable, depending on what the specific machine returns).

For the details of ASCII control, please refer to "10. RS-232 Control Command".

Step 2: Connect the TCP/IP port of the Matrix to a PC with an UTP cable, and set the IP address of the PC to be in the same network segment with the Matrix.

Step 3: Input the IP address of the Matrix into your browser on the PC to enter Web GUI page. There will be a Login page, as shown below:

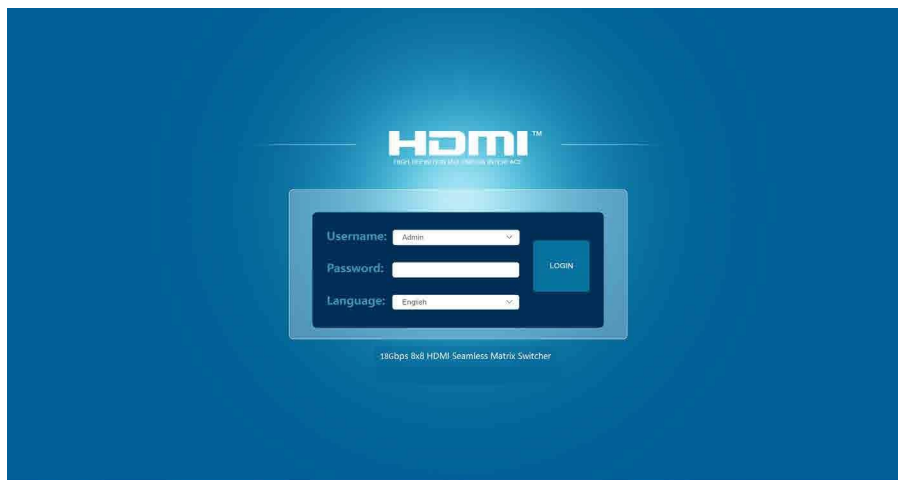

Select the Username and enter the password. The default password is:

Username **User / Admin**

Password **user / admin**

Select the username "Admin", enter the password "admin", and select the desired language. Then click the "LOGIN" button and the following Status page will appear.

■ Status Page

The Status page provides basic information about the Model, the installed firmware version and the network settings of the device.

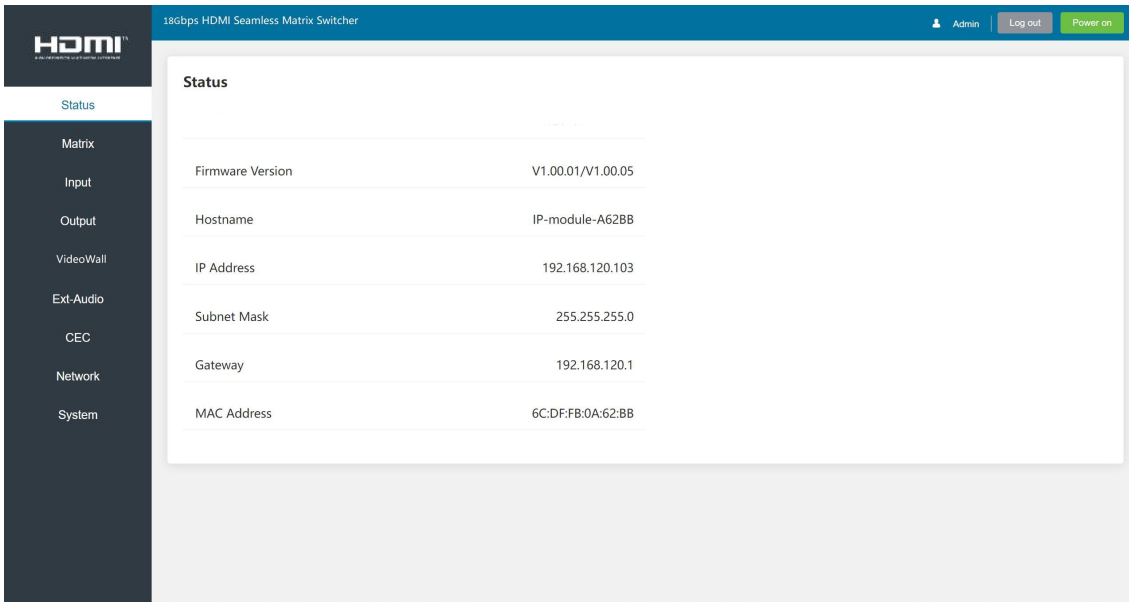

■ Matrix Page

In Matrix page, you can configure the HDMI matrix freely and create a preset if needed.

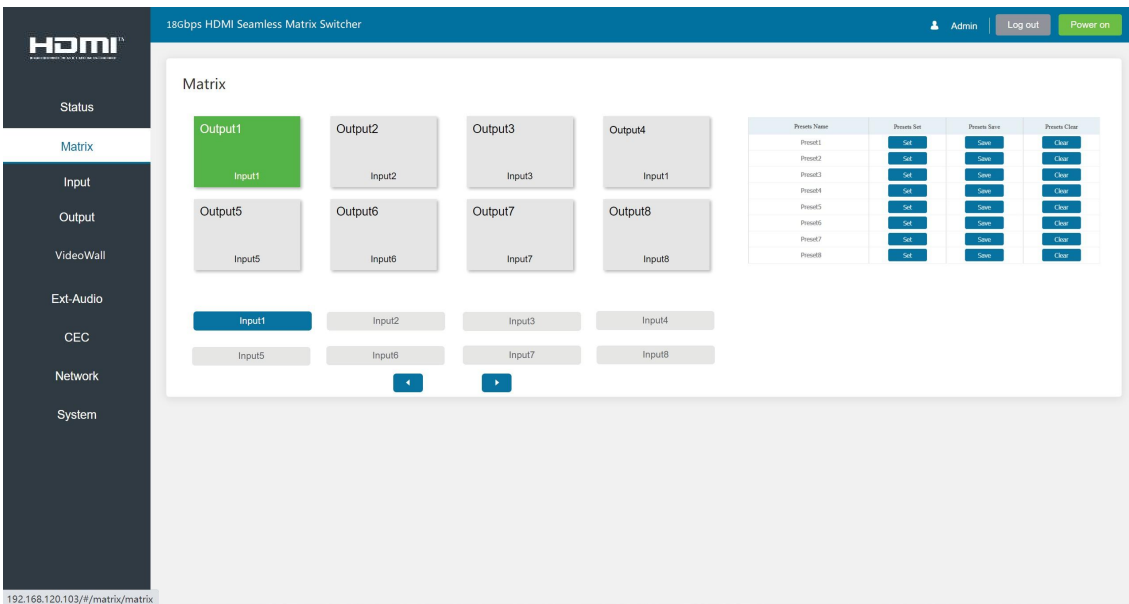

① **Matrix:** you can click and select an output (1~8) firstly, and then select an input source (1~8) below which will appear in the selected output area. One route of video output configuration is completed. You can switch it freely.

② **Preset:** you can set, save or clear any route video matrix configuration if needed.

■ Input Page

The screenshot shows the 'Input Setting' page of a 18Gbps HDMI Seamless Matrix Switcher. The page has a dark sidebar with navigation options: Status, Matrix, Input (selected), Output, VideoWall, Ext-Audio, CEC, Network, and System. The main content area is titled 'Input Setting' and contains a table with the following data:

Inputs	Active	Name	EDID
HDMI 1	●	Input1	4K2K60,2.0CH
HDMI 2	●	Input2	4K2K60,2.0CH
HDMI 3	●	Input3	4K2K60,2.0CH
HDMI 4	●	Input4	4K2K60,2.0CH
HDMI 5	●	Input5	4K2K60,2.0CH
HDMI 6	●	Input6	4K2K60,2.0CH
HDMI 7	●	Input7	4K2K60,2.0CH
HDMI 8	●	Input8	4K2K60,2.0CH

Below the table, there are two sections for EDID management:

- Load EDID to user memory:** Includes a 'Select EDID File:' field with a 'Browse...' button, a 'Select Destination:' dropdown menu (currently set to 'User Define1'), and an 'Upload' button.
- DownLoad EDID to your computer:** Includes a 'Select EDID File:' dropdown menu (currently set to 'HDMI IN1') and a 'Download' button.

You can do the following operations on the Input page:

- ① **Inputs:** Input channel of the device.
- ② **Active:** It indicates whether the channel is connected to a signal source. It is green if the input signal is detected, and gray if no signal.
- ③ **Name:** The input channel's name. You can modify it by entering the corresponding name (max length: 32 characters) in the input box.
- ④ **EDID:** It indicates the current EDID of the device. You can click the drop-down menu to select other EDIDs.
- ⑤ **Load EDID to user memory:** Set EDID for the User. Click the "Browse" button, then select the bin file. If you select the wrong EDID file, there will be a prompt, as shown in the following figure:

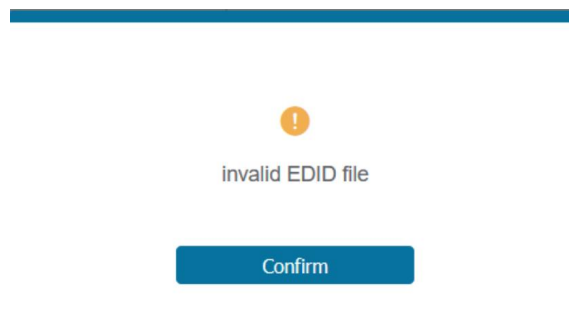

Make sure to select the correct file, then you can check the name of the selected file. Then select destination "User Define1/User Define2", and click "Upload".

This screenshot shows the 'Load EDID to user memory' section. The 'Select EDID File:' field now displays the filename '4K60(3840x1080) 2.0ch v2.'. The 'Select Destination:' dropdown menu is open, showing two options: 'User Define1' (highlighted with a red box) and 'User Define2'. The 'Upload' button is visible to the right.

After successful setting, it will prompt as follows:

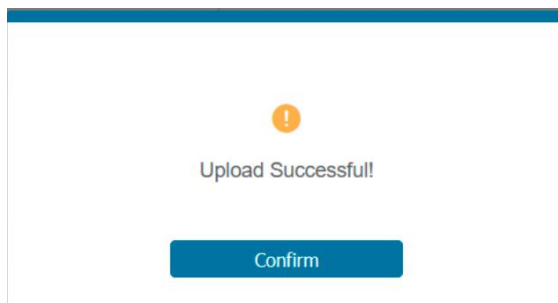

⑥ Download EDID to your computer:

If you want to download the existing EDID, click the drop-down box of “Select EDID File” to select the input channel you want, and then click “Download” to save the corresponding EDID file to your computer.

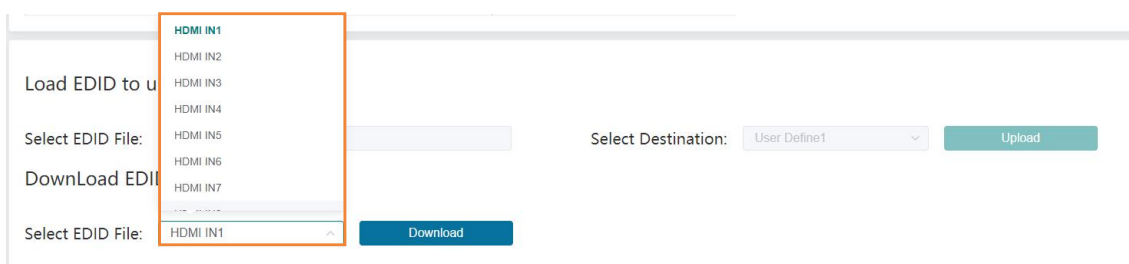

■ Output Page

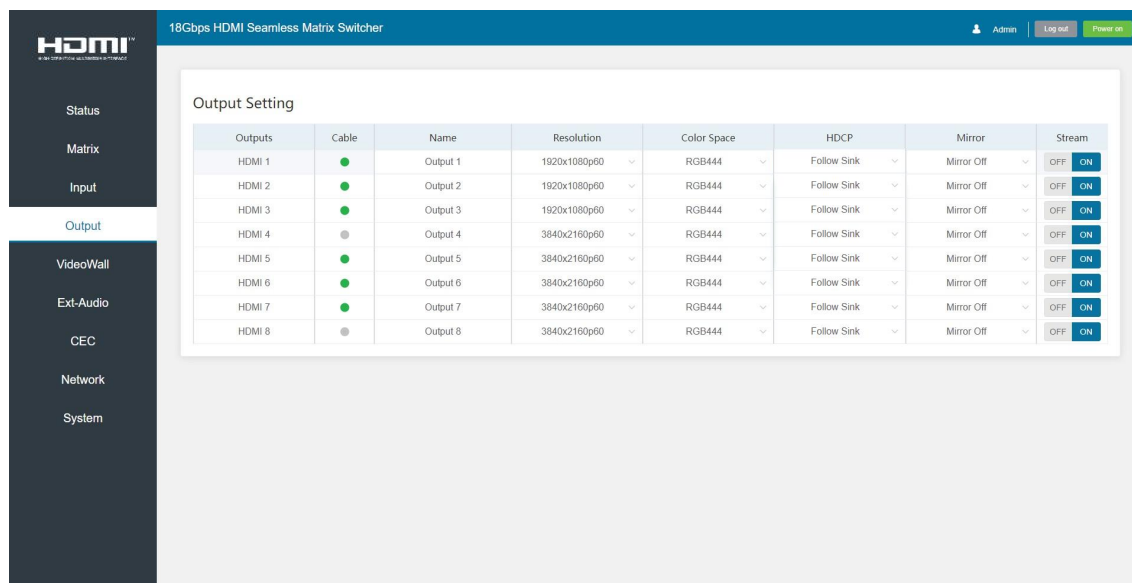

You can do the following operations on the Output page:

- ① **Outputs:** Output channel of the device.
- ② **Cable:** It indicates the connection status of output ports. When the output port is connected to the display, it shows green. Otherwise, it shows gray.
- ③ **Name:** The output channel’s name. You can modify it by entering the corresponding name (max length: 32 characters) in the input box.

④ **Resolution:** Set the video resolution for current output. Click the drop-down menu and set the resolution you need. There are 16 options to be selected. If you select AUTO, it will output the proper video resolution according to the EDID of the display device.

Output Setting

Outputs	Cable	Name	Resolution	Color Space	HDCP	Mirror	Stream
HDMI 1	●	Output 1	1920x1080p60	RGB444	Follow Sink	Mirror Off	OFF ON
HDMI 2	●	Output 2	4096x2160p60	RGB444	Follow Sink	Mirror Off	OFF ON
HDMI 3	●	Output 3	4096x2160p50	RGB444	Follow Sink	Mirror Off	OFF ON
HDMI 4	●	Output 4	3840x2160p60	RGB444	Follow Sink	Mirror Off	OFF ON
HDMI 5	●	Output 5	3840x2160p50	RGB444	Follow Sink	Mirror Off	OFF ON
HDMI 6	●	Output 6	3840x2160p30	RGB444	Follow Sink	Mirror Off	OFF ON
HDMI 7	●	Output 7	1920x1080p60	RGB444	Follow Sink	Mirror Off	OFF ON
HDMI 8	●	Output 8	1920x1080p50	RGB444	Follow Sink	Mirror Off	OFF ON

⑤ **Color Space:** Set the color space for current output. Click the drop-down menu and select the item as required. There are four options to be selected.

Output Setting

Outputs	Cable	Name	Resolution	Color Space	HDCP	Mirror	Stream
HDMI 1	●	Output 1	1920x1080p60	RGB444	Follow Sink	Mirror Off	OFF ON
HDMI 2	●	Output 2	1920x1080p60	RGB444	Follow Sink	Mirror Off	OFF ON
HDMI 3	●	Output 3	1920x1080p60	RGB444	Follow Sink	Mirror Off	OFF ON
HDMI 4	●	Output 4	3840x2160p60	YCbCr422	Follow Sink	Mirror Off	OFF ON
HDMI 5	●	Output 5	3840x2160p60	YCbCr420	Follow Sink	Mirror Off	OFF ON
HDMI 6	●	Output 6	3840x2160p60	RGB444	Follow Sink	Mirror Off	OFF ON
HDMI 7	●	Output 7	3840x2160p60	RGB444	Follow Sink	Mirror Off	OFF ON
HDMI 8	●	Output 8	3840x2160p60	RGB444	Follow Sink	Mirror Off	OFF ON

⑥ **HDCP:** Click the drop-down menu and set the HDCP version for current output.

Output Setting

Outputs	Cable	Name	Resolution	Color Space	HDCP	Mirror	Stream
HDMI 1	●	Output 1	1920x1080p60	RGB444	Follow Sink	Mirror Off	OFF ON
HDMI 2	●	Output 2	1920x1080p60	RGB444	Follow Sink	Mirror Off	OFF ON
HDMI 3	●	Output 3	1920x1080p60	RGB444	Follow Sink	Mirror Off	OFF ON
HDMI 4	●	Output 4	3840x2160p60	RGB444	Follow Sink	Mirror Off	OFF ON
HDMI 5	●	Output 5	3840x2160p60	RGB444	Follow Sink	Mirror Off	OFF ON
HDMI 6	●	Output 6	3840x2160p60	RGB444	Follow Sink	Mirror Off	OFF ON
HDMI 7	●	Output 7	3840x2160p60	RGB444	Follow Sink	Mirror Off	OFF ON
HDMI 8	●	Output 8	3840x2160p60	RGB444	Follow Sink	Mirror Off	OFF ON

There are five options to be selected:

- HDCP1.4: HDCP 1.4 compliant.
- HDCP2.2: HDCP 2.2 compliant.
- Follow Sink: HDCP version follows the corresponding display device.
- Follow Source: HDCP version follows the assigned input source.
- User Mode: Supports user-defined mode.

⑦ **Mirror:** Click the drop-down menu and set the mirror mode for current output.

There are four options to be selected:

- Mirror Off: Turn off the mirror function.
- H Mirror On: Set horizontal mirror for the output signal.
- V Mirror On: Set vertical mirror for the output signal.
- H+V Mirror On: Set horizontal and vertical mirror for the output signal.

Output Setting							
Outputs	Cable	Name	Resolution	Color Space	HDCP	Mirror	Stream
HDMI 1	●	Output 1	1920x1080p60	RGB444	Follow Sink	Mirror Off	OFF ON
HDMI 2	●	Output 2	1920x1080p60	RGB444	Follow Sink	Mirror Off	OFF ON
HDMI 3	●	Output 3	1920x1080p60	RGB444	Follow Sink	Mirror Off	OFF ON
HDMI 4	●	Output 4	3840x2160p60	RGB444	Follow Sink	Mirror Off	OFF ON
HDMI 5	●	Output 5	3840x2160p60	RGB444	Follow Sink	Mirror Off	OFF ON
HDMI 6	●	Output 6	3840x2160p60	RGB444	Follow Sink	Mirror Off	OFF ON
HDMI 7	●	Output 7	3840x2160p60	RGB444	Follow Sink	Mirror Off	OFF ON
HDMI 8	●	Output 8	3840x2160p60	RGB444	Follow Sink	Mirror Off	OFF ON

⑧ **Stream:** Turn on/off the output stream.

■ Video Wall Page

You can do the following operations on the Video Wall page:

- ① **Video Wall Setting:** Set the splicing mode, such as 1x8, 2x3. The range of Rows and Columns is 1~8. Click Read button to refresh the system setting. Click Set button to confirm current setting.
- ② **Presets:** Set, save or clear the presets. You can rename it if needed, and the max length of a preset name is 32 characters.
- ③ **Video Wall:** After setting rows and columns, click Set button and it will be displayed in Video Wall area. Aspect ratio of each window is 16:9.

In Video Wall area, you can drag the mouse and choose the adjacent screens to splice. The splicing screen is distinguished by a color automatically.

Note: Before splicing, it is necessary to assign each spliced screen to the output port via right-click menu.

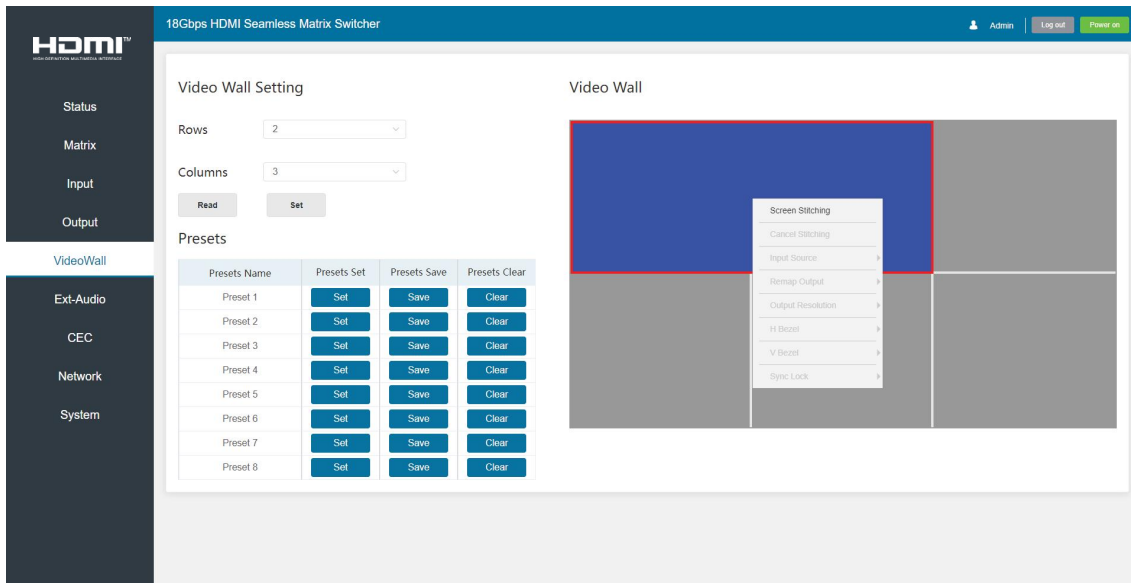

To the splicing screens, you can configure them at the same time by the right-click menu.

- Cancel the splicing screens.
- Select an input source.
- Specify an output resolution.
- Adjust horizontal and vertical bezel.
- Set the screens output synchronization.

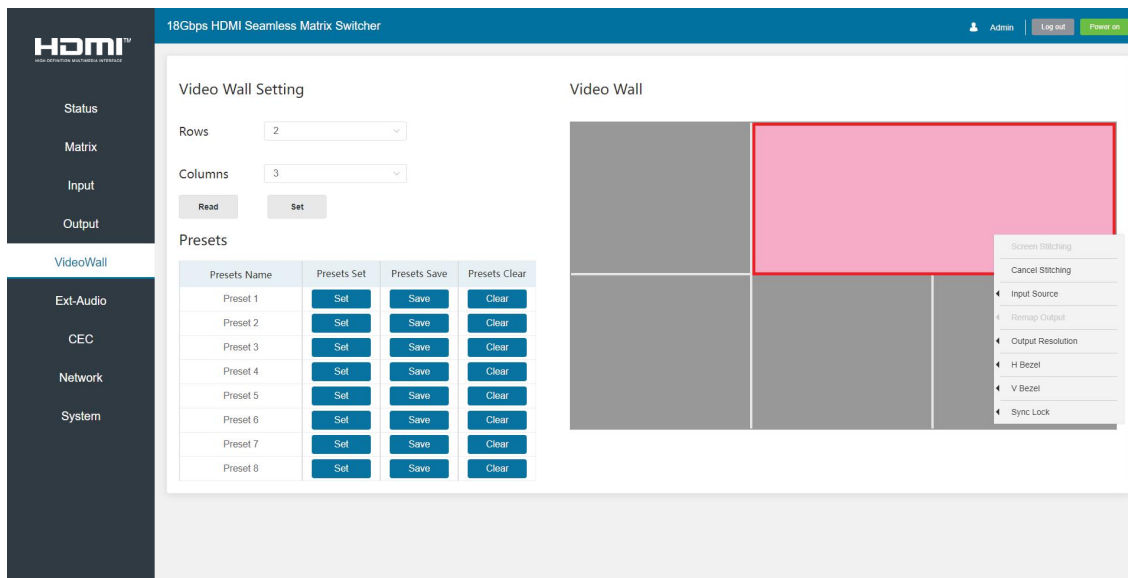

■ Ext-Audio Page

You can set the audio mode on the Ext-Audio page. There are three modes: Bind to Input, Bind to Output and Audio Matrix.

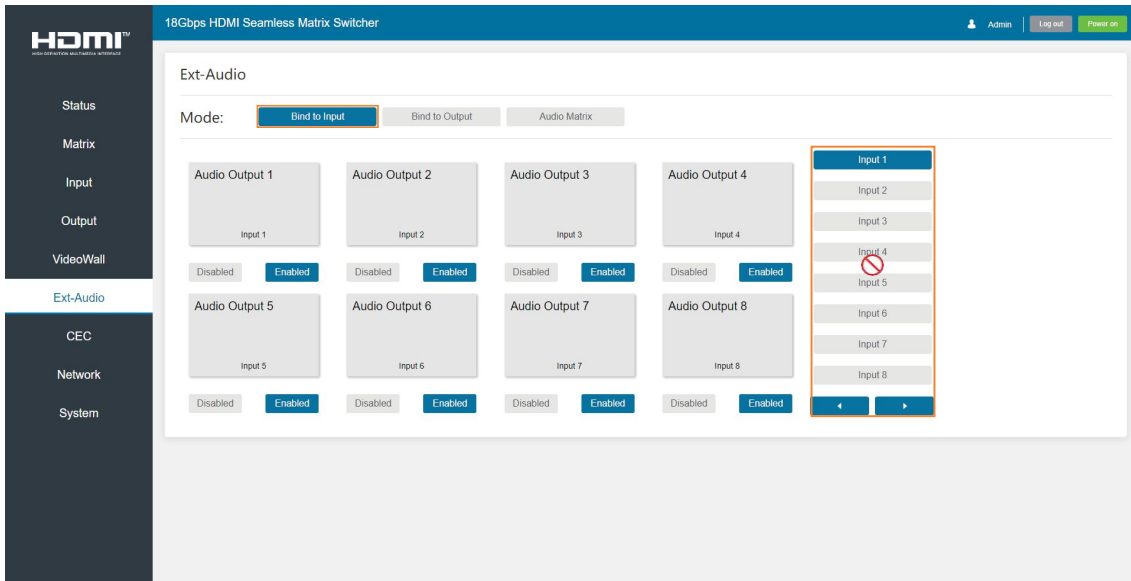

Bind to Input: The Audio Output follows the HDMI Input. And there is a consistent one-to-one match between each HDMI input and audio output.

Click Enable/Disable button to turn on/off the audio channel.

In this mode, the input sources can't be selected.

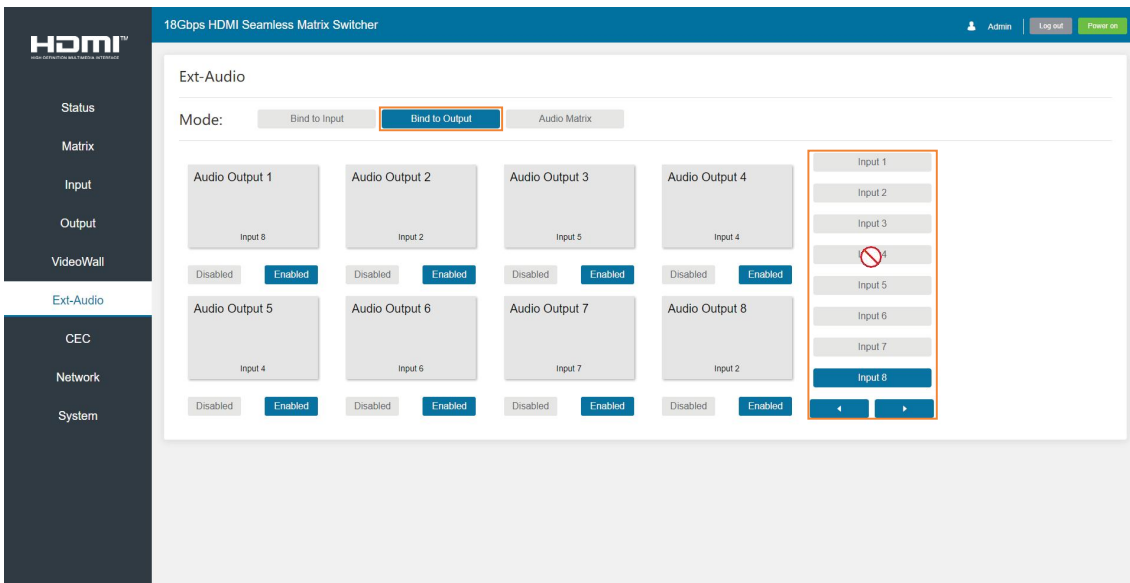

Bind to Output: The Audio Output follows the HDMI Output. For example, if the HDMI Input 3 is assigned to the HDMI Output 1, the audio of AUDIO Output 1 which follows HDMI Output 1 is from HDMI Input 3.

Click Enable/Disable button to turn on/off the audio channel.

In this mode, the input sources can't be selected.

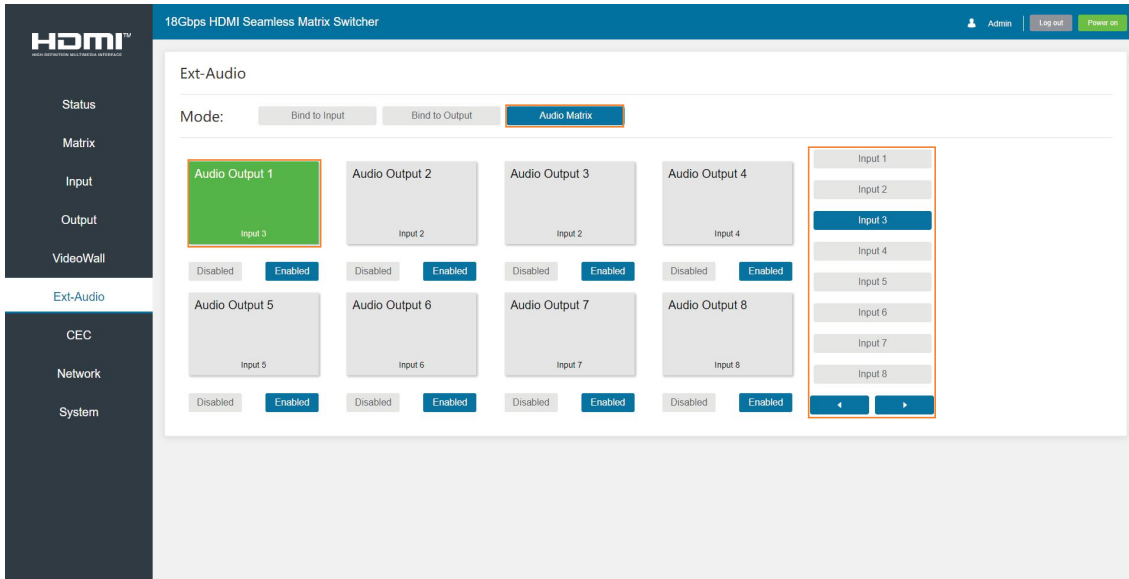

Audio Matrix: This mode allows you to matrix the extracted audio independently. Click on an Audio Out, and then select any input source on the right which will appear below the selected audio out. One route of audio configuration is completed.

Click Enable/Disable button to turn on/off the corresponding audio channel.

■ CEC Page

You can perform CEC management on this page. Inputs and Outputs can be controlled by clicking on the corresponding icons.

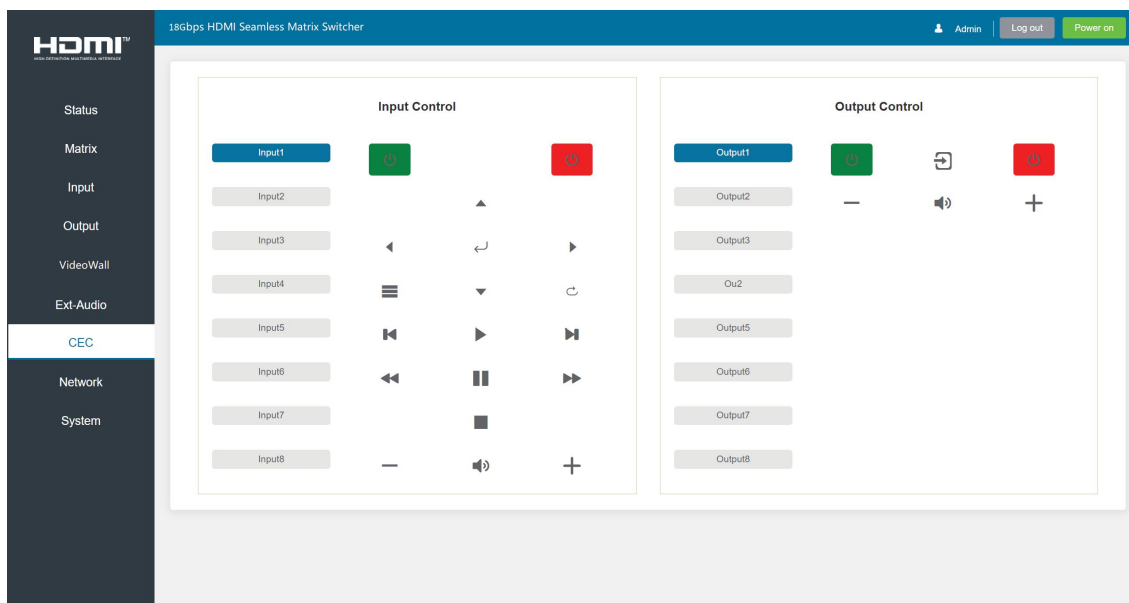

① **Input Control:** Select the input source on the left, and then click on the icons to power on, power off, return, switch, pause, fast-forward, fast-back, mute, unmute, etc.

② **Output Control:** Select the output on the left, and then click on the icons to control the operation of the display, such as power on/off, volume +/-, etc.

■ Network Page

The screenshot shows the Network page of the HDMI 18Gbps Seamless Matrix Switcher. The page is divided into two main sections: IP Setting and Web Login Setting. The IP Setting section has a toggle for IP Mode, currently set to Static. Below this are input fields for IP Address (192.168.120.103), Gateway (192.168.120.1), Subnet (255.255.255.0), and Telnet Port (23). There is also a TCP Port field set to 8000. The Web Login Setting section has a toggle for Username, currently set to Admin. Below this are input fields for Old Password, New Password, and Confirm Password. At the bottom of the page, there are buttons for 'Set Network Defaults' and 'Save'.

You can do the following operations on the Network page:

① Modify Network Setting:

Modify the IP Mode/IP Address/Gateway/Subnet Mask/Telnet Port as required, click “Save” to save the settings, and then it will come into effect.

This screenshot shows the IP Setting section with the 'Static' mode selected. The IP Address field is set to 192.168.66.10, the Gateway is 192.168.66.1, the Subnet is 255.255.255.0, and the Telnet Port is 23. The TCP Port is 8000. The 'Static' and 'DHCP' buttons are visible, with 'Static' being the active one.

If the Mode is “Static”, you can set manually the IP Address/Gateway/Subnet/Telnet Port as required.

This screenshot shows the IP Setting section with the 'DHCP' mode selected. The IP Address field is set to 192.168.66.10, the Gateway is 192.168.66.1, the Subnet is 255.255.255.0, and the Telnet Port is 23. The TCP Port is 8000. The 'Static' and 'DHCP' buttons are visible, with 'DHCP' being the active one.

If the Mode is “DHCP”, IP parameters are assigned by the outer router. If no router connected, it will be a default value.

② Modify User Password:

Click the “Admin” button, enter the correct Old Password, New Password, and Confirm Password, and then click “Save”. After successful modification, there will be a prompt, as shown in the following figure:

Web Login Setting

User Name User Admin

Old Password

New Password

Confirm Password

Product Model

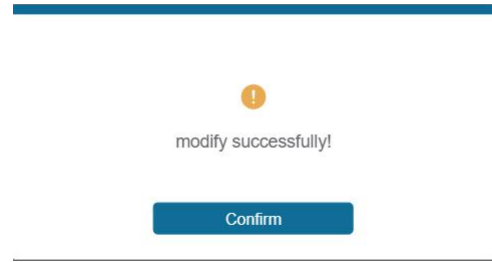

Note: Input rules for changing passwords:

- (1) The password can't be empty.
- (2) New Password can't be the same as Old Password.
- (3) New Password and Confirm Password must be the same.

③ Set the Default Network:

Click "Set Network Defaults", there will be a prompt, as shown in the following figure:

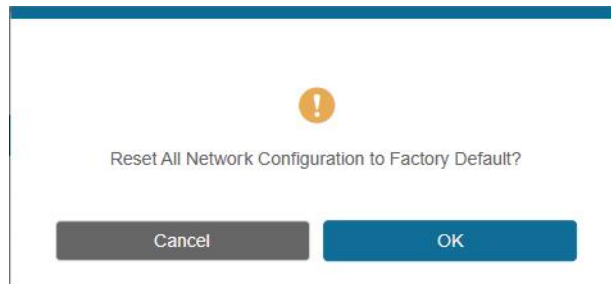

Click "OK" to search the IP Address again. After searching is completed, it will switch to the login page, the default network setting is completed.

■ System Page

The screenshot shows the "System" page of the "18Gbps HDMI Seamless Matrix Switcher" web interface. The page has a dark sidebar with navigation options: Status, Matrix, Input, Output, VideoWall, Ext-Audio, CEC, Network, and System (highlighted). The main content area includes several settings sections:

- Panel Lock:** A toggle switch currently set to "OFF".
- Beep:** A toggle switch currently set to "OFF".
- LCD ON TIME:** A selection menu with options: OFF, Always ON, 15s, 30s, and 60s (selected).
- Pattern:** A selection menu with options: Black Screen, Blue Screen, Color Bar, Gray Scale, Cross, and Cross Hatch (selected).
- Serial Baud Rate:** A selection menu with options: 4800, 9600, 19200, 38400, 57600, and 115200 (selected).
- Firmware Update:** A section with a "Browse..." button, a text input field, and an "Update" button.
- Factory Reset:** A section with a "Reset" button.
- Reboot:** A section with a "Reboot" button.

The top right of the interface shows the user is logged in as "Admin" with "Log out" and "Power on" buttons.

You can do the following operations on the System page:

- ① **Panel Lock:** Click “ON/OFF” to lock/unlock panel buttons. “ON” indicates that panel buttons are unavailable; “OFF” indicates panel buttons are available.
- ② **Beep:** Turn on/off the beep.
- ③ **LCD On Time:** You can set the display duration time (OFF/Always ON/15s/30s/60s).
- ④ **Pattern:** Click to select 6 patterns to test the display effect of the display device.
- ⑤ **Serial Baud Rate:** Click the value to set the Serial Baud Rate.
- ⑥ **Firmware Update:** Click “Browse” to select the update file, and then click “Update” to complete firmware update.
- ⑦ **Factory Reset:** Reset the unit to factory defaults by clicking “Reset”.
- ⑧ **Reboot:** Reboot the unit by clicking “Reboot”.

Note: After reset/reboot, it will switch to the login page.

10. RS-232 Control Command

The product also supports RS-232 control. Connect the RS-232 control port on Matrix to a PC with the provided USB to RS-232 serial cable. The connection method is as follows:

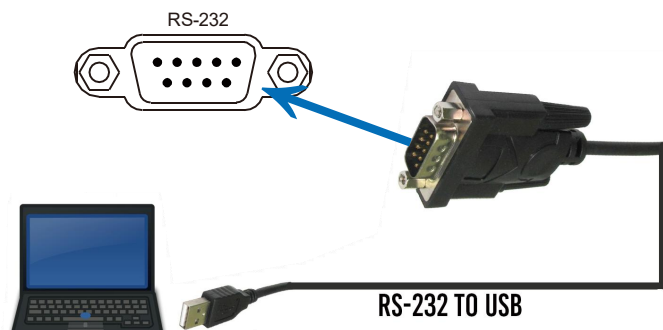

Then, open a Serial Command tool on PC to send ASCII command to control the Matrix. The ASCII command list about the product is shown as below.

ASCII Command				
Serial port protocol. Baud rate: 115200 (Default), Data bits: 8, Stop bits:1, Check bit: 0				
x, y, z, XXX are parameters				
Error Code describe: E00 -> unkown command E01 -> parameter out of range E02 -> get the error edid data				
Command Code	Function Description	Example	Feedback	Default Setting
System Setting				
help!	List all commands	help!		
r status!	Get device current status	r status!	get the unit all status: power, beep, lock, in/out connection, video/audio crosspoint, edid, scaler, network status	
r fw version!	Get firmware version	r fw version!	mcu fw version :1.00.05 web gui version :2.00.07 cpld version :1.00.03 audio version :1.00.01 key version :0.00.00	
s power z!	Power on/off the device, z=0~1 (z=0 power off, z=1 power on)	s power 1!	power on system initializing... cpld fw: 1.00.03 audio fw: 1.00.01 mcu fw version :1.00.05 web gui version :2.00.07 key version :0.00.00 initialization finished! search for ip,please wait ...!	
r power!	Get current power state	r power!	power on /power off	
s beep z!	Enable/disable buzzer function, z=0~1 (z=0 beep off, z=1 beep on)	s beep 1!	beep on beep off	beep off

Command Code	Function Description	Example	Feedback	Default Setting
System Setting				
r beep!	Get buzzer state	r beep!	beep on / beep off	
s lock z!	Lock/unlock front panel button, z=0~1 (z=0 lock off, z=1 lock on)	s lock 1!	panel button lock on panel button lock off	panel button lock off
r lock!	Get panel button lock state	r lock!	panel button lock on/off	
s lcd on time z!	Set lcd screen remain on time, z=0~4 (0:off 1:always, 2:15s, 3:30s, 4:60s)	s lcd on time 3!	lcd on 30 seconds	lcd on 30 seconds
r lcd mode!	Get the backlight status of lcd screen	r lcd mode!	lcd always on	
s logo1 *****!	Set the logo name displayed on the first line of lcd screen, the max character is 16	s logo1 Matrix Switch!	logo1:Matrix Switch	
s reboot!	Reboot the device	s reboot!	reboot... system initializing... cpld fw: 1.00.03 audio fw: 1.00.01 mcu fw version: 1.00.05 web gui version: 2.00.07 key version: 0.00.00 initialization finished! search for ip,please wait ...!	
s baud rate x!	Set RS232 baudrate x=1~6 (1:115200, 2:57600, 3:38400, 4:19200, 5:9600, 6:4800)	s baud rate 1!	s baud rate 115200	115200
s fan x y!	Set fans on/off (x=0~2, y=0~1) x=0, all fans x=1, side fans x=2, top fans y=0, off y=1, on	s fan 2 0!	set top fans off	side fans:off top fans:on
s reset!	Reset to factory defaults	s reset!	reset to factory defaults system initializing... cpld fw: 1.00.03 audio fw: 1.00.01 mcu fw version: 1.00.05 web gui version: 2.00.07 key version: 0.00.00 initialization finished! search for ip, please wait ...!	
r device sn!	get device serial number	r device sn!	serial number:12345634534	

Command Code	Function Description	Example	Feedback	Default Setting
Output Setting				
s output x res y!	Set output x resolution (x=0~8 (0=all output), y=1~16) 1. 4096x2160p60, 2. 4096x2160p50, 3. 3840x2160p60, 4. 3840x2160p50, 5. 3840x2160p30, 6. 1920x1080p60, 7. 1920x1080p50, 8. 1920x1080i60, 9. 1920x1080i50, 10. 1920x1200p60rb, 11. 1360x768p60, 12. 1280x800p60, 13. 1280x720p60, 14. 1280x720p50, 15. 1024x768p60, 16. auto	s output 1 res 3!	output 1 resolution: 3840x2160p60	3840x2160p60
r output x res!	Get output x resolution (y=0~8 (0=all output))	r output 1 res!	output 1 resolution: 3840x2160p60	
s output x csc y!	Set output x color space (x=0~8 (0=all output), y=1~4) y=1. rgb444 y=2. ycbcr444 y=3. ycbcr422 y=4. ycbcr420	s output 1 csc 1!	output 1 csc: rgb444	rgb444
r output x csc!	Get output x color space status. (x=0~8 (0=all output))	r output 1 csc!	output 1 csc: rgb444	
s output x hdcp y!	Set output hdcp (x=0~8 (0=all output), y=1~5) y=1. hdcp 1.4 y=2. hdcp 2.2 y=3. follow sink y=4. follow source y=5. user mode	s output 1 hdcp 1!	output 1 hdcp: hdcp 1.4	follow sink
r output x hdcp!	Get output x hdcp status. (x=0~8 (0=all output))	r output 1 hdcp!	output 1 hdcp: hdcp 1.4	
s output x mirror y!	Set output y mirror mode (x=0~8(0=all output),y=0~3) y=0. mirror off y=1. h mirror on y=2. v mirror on y=3. h+v mirror on	s output 1 mirror 0!	output 1 mirror off	output 1 mirror off output 2 mirror off output 3 mirror off output 4 mirror off output 5 mirror off output 6 mirror off output 7 mirror off output 8 mirror off
r output x mirror!	Get output x mirror status (x=0~8 (0=all output))	r output 1 mirror!	output 1 h mirror off	
s output x stream y!	Set output x stream enable/disable (x=0~8 (0=all output), y=0~1) y=0. stream disable y=1. stream enable	s output 1 stream 1!	output 1 stream: enable	enable

Command Code	Function Description	Example	Feedback	Default Setting
Output Setting				
r output x stream!	Get output x stream status. (x=0~8 (0=all output))	r output 1 stream!	output 1 stream: enable	
s output bg x!	Set output no signal background display mode (x=1~6) x=1. black screen x=2. blue screen x=3. color bar x=4. gray scale x=5. cross x=6. cross hatch	s output bg 1!	output background: black screen	black screen
r output bg!	Get output no signal background display mode	r output bg!	output background: black screen	
EDID Setting				
s input x edid z!	Set hdmi input x edid mode (x=0~8 (0=all input), z=1~22) z=1. 4k60, 2.0ch z=15. copy out1 z=2. 4k60, 5.1ch z=16. copy out2 z=3. 4k60, 7.1ch z=17. copy out3 z=4. 4k30, 2.0ch z=18. copy out4 z=5. 4k30, 5.1ch z=19. copy out5 z=6. 4k30, 7.1ch z=20. copy out6 z=7. 1080p, 2.0ch z=21. copy out7 z=8. 1080p, 5.1ch z=22. copy out8 z=9. 1080p, 7.1ch z=10. wuxga, 2.0ch z=11. 768p, 2.0ch z=12. xga, 2.0ch z=13. user1 z=14. user2	s input 1 edid 1!	input 1 edid: 4k60, 2.0ch	4k60, 2.0ch
r input x edid!	Get input x edid mode (x=0~8 (0=all input))	r input 1 edid!	input 1 edid: 4k60, 2.0ch	
Video Matrix Setting				
s display mode x!	Set output display mode (x=0~1) x=0 matrix mode x=1 video wall mode	s display mode 0!	display mode: martrix	matrix
r display mode!	Get output display mode	r display mode!	display mode: martrix	
s output x in source y!	Route input source to output x (x=0~8, y=1~8) x=0. output all x=1. output 1 x=2. output 2 x=3. output 3 x=4. output 4 x=5. output 5 x=6. output 6 x=7. output 7 x=8. output 8 y=1. input1 y=2. input2 y=3. input3 y=4. input4 y=5. input5 y=6. input6 y=7. input7 y=8. input8	s output 1 in source 1!	output 1->input 1	output 1->input 1 output 2->input 2 output 3->input 3 output 4->input 4 output 5->input 5 output 6->input 6 output 7->input 7 output 8->input 8
r output x in source!	Get output x selected input source (x=0~8 (0=all output))	r output 1 in source!	output 1->input 1	

Command Code	Function Description	Example	Feedback	Default Setting
Video Matrix Setting				
save mx preset z!	Save matrix state to preset z, z=1~8	save mx preset 1!	save to preset 1	
recall mx preset z!	Recall matrix preset z scenarios, z=1~8	recall mx preset 1!	recall from preset 1	
clear mx preset z!	Clear matrix preset z scenarios, z=1~8	clear mx preset 1!	clear preset 1	
r mx preset z!	Get matrix preset z information, z=1~8	r mx preset 1!	video/audio crosspoint	
Video Wall Setting				
create vw screen row x col y!	Create video wall screen rows and columns layouts (x=1~8, y=1~8)	create vw screen row 2 col 4!	create vw screen 2x4	
s screen x output y!	Set hdmi output y to screen x (x=1~8, y=1~8)	s screen 1 output 1!	hdmi output1->screen 1	hdmi output 1->screen 1 hdmi output 2->screen 2 hdmi output 3->screen 3 hdmi output 4->screen 4 hdmi output 5->screen 5 hdmi output 6->screen 6 hdmi output 7->screen 7 hdmi output 8->screen 8
s vw group z row x col y!	Set video wall group z rows and columns (z<=1~4, x=1~8, y=1~8, x*y<=8)	s vw group 1 row 1 col 2!	vw group 1 row 1 col 2!	
s vw group z screen abcd!	Set video wall group z screen number (z<=1~4)	s vw group 2 screen 2367!	vw group 2 screen 2367!	
s vw group z source x!	Set video wall group z select input source (z<=1~4, x<=1~8)	s vw group 1 source 1!	vw group 1 source 1!	
s vw group z hbezel x!	set video wall group z horizontal bezel (z<=1~4, x=0~10)	s vw group 1 hbezel 0!	video wall group 1 h bezel: 0	video wall group 1 h bezel: 0
s vw group z vbezel y!	set video wall group z vertical bezel (z<=1~4, x=0~10)	s vw group 1 vbezel 0!	video wall group 1 v bezel: 0	video wall group 1 v bezel: 0
s vw group z out res x!	Set video wall group z output resolution (z=1~4,x=1~15) 1. 4096x2160p60, 2. 4096x2160p50, 3. 3840x2160p60, 4. 3840x2160p50, 5. 3840x2160p30, 6. 1920x1080p60, 7. 1920x1080p50, 8. 1920x1080i60, 9. 1920x1080i50, 10. 1920x1200p60rb, 11. 1360x768p60, 12. 1280x800p60, 13. 1280x720p60, 14. 1280x720p50, 15. 1024x768p60,	s vw group 1 out res 6!	video wall group 1 resolution: 1920x1080p60	1920x1080p60
delete vw group z!	Delete video wall group z config (z=1~4)	delete vw group 1!	delete vw group 1!	

Command Code	Function Description	Example	Feedback	Default Setting
Video Wall Setting				
r vw info!	Get current video wall scene information	r vw info!	===== ===== ===== video wall info: row :2 col :4 output: 1 2 3 4 5 6 7 8 input: 4 4 4 4 4 4 4 4 mosaic number:1 mosaic id:1 mosaic row:2 mosaic col:2 mosaic src:4 mosaic res:3840x2160p60 mosaic screen: 1 2 5 6 B85	
save vw preset z!	Save video wall state to preset z, z=1~8	save vw preset 1!	save to preset 1	
recall vw preset z!	Recall video wall preset z scenarios, z=1~8	recall vw preset 1!	recall from preset 1	
clear vw preset z!	Clear video wall preset z scenarios, z=1~8	clear vw preset 1!	clear preset 1	
r vw preset z!	Get video wall preset z information, z=1~8	r vw preset 1!	video/audio crosspoint	
EXT- Audio Setting				
s output x exa y!	set output x ext-audio enable/disable (x=0~8 (0=all output), y=0~1) y=0. ext-audio disable y=1. ext-audio enable	s output 1 exa 1!	output 1 ext-audio: enable	enable
r output x exa!	get output x ext-audio enable/disable status. (x=0~8 (0=all output))	r output 1 exa!	output 1 ext-audio: enable	
s output exa mode x!	Set output ext-audio mode(x=0~2) x=0. bind to input mode x=1. bind to output mode x=2. matrix mode	s output exa mode 0!	output ext-audio moe: bind to input	bind to output
r output exa mode!	Get output ext-audio mode	r output exa mode!	output ext-audio moe: bind to input	
s output x exa in source y!	Route input source audio y to output ext-audio x (x=0~8(0=all output), y=0~8) y=1. input1 y=2. input2 y=3. input3 y=4. input4 y=5. input5 y=6. input6 y=7. input7 y=8. input8	s output 1 exa in source 1!	output 1 ext-audio ->input 1	output 1 ext-audio->input 1 output 2 ext-audio->input 2 output 3 ext-audio->input 3 output 4 ext-audio->input 4 output 5 ext-audio->input 5 output 6 ext-audio->input 6 output 7 ext-audio->input 7 output 8 ext-audio->input 8
r output y exa in source!	Get output y ext-audio selected input source (y=0~8 (0=all output))	r output 0 exa in source!	output 1 ext-audio->input 1 output 2 ext-audio->input 2 output 3 ext-audio->input 3 output 4 ext-audio->input 4 output 5 ext-audio->input 5 output 6 ext-audio->input 6 output 7 ext-audio->input 7 output 8 ext-audio->input 8	

Command Code	Function Description	Example	Feedback	Default Setting
CEC Setting				
s cec in x on!	Set input x power on by cec, x=0~8 (0=all input)	s cec in 1 on!	input 1 power on	
s cec in x off!	Set input x power off by cec, x=0~8 (0=all input)	s cec in 1 off!	input 1 power off	
s cec in x menu!	Set input x open menu by cec, x=0~8 (0=all input)	s cec in 1 menu!	input 1 open menu	
s cec in x back!	Set input x back operation by cec, x=0~8 (0=all input)	s cec in 1 back!	input 1 back operation	
s cec in x up!	Set input x menu up operation by cec, x=0~8 (0=all input)	s cec in 1 up!	input 1 menu up operation	
s cec in x down!	Set input x menu down operation by cec, x=0~8 (0=all input)	s cec in 1 down!	input 1 menu down operation	
s cec in x left!	Set input x menu left operation by cec, x=0~8 (0=all input)	s cec in 1 left!	input 1 menu left operation	
s cec in x right!	Set input x menu right operation by cec, x=0~8 (0=all input)	s cec in 1 right!	input 1 menu right operation	
s cec in x enter!	Set input x menu enter by cec, x=0~8 (0=all input)	s cec in 1 enter!	input 1 menu enter operation	
s cec in x play!	Set input x play by cec, x=0~8 (0=all input)	s cec in 1 play!	input 1 play operation	
s cec in x pause!	Set input x pause by cec, x=0~8 (0=all input)	s cec in 1 pause!	input 1 pause operation	
s cec in x stop!	Set input x stop by cec, x=0~8 (0=all input)	s cec in 1 stop!	input 1 stop operation	
s cec in x rew!	Set input x rewind by cec, x=0~8 (0=all input)	s cec in 1 rew!	input 1 rewind operation	
s cec in x mute!	Set input x volume mute by cec, x=0~8 (0=all input)	s cec in 1 mute!	input 1 volume mute	
s cec in x vol-!	Set input x volume down by cec, x=0~8 (0=all input)	s cec in 1 vol-!	input 1 volume down	
s cec in x vol+!	Set input x volume up by cec, x=0~8 (0=all input)	s cec in 1 vol+!	input 1 volume up	
s cec in x ff!	Set input x fast forward by cec, x=0~8 (0=all input)	s cec in 1 ff!	input 1 fast forward operation	
s cec in x previous!	Set input x previous by cec, x=0~8 (0=all input)	s cec in 1 previous!	input 1 previous operation	
s cec in x next!	Set input x next by cec, x=0~8 (0=all input)	s cec in 1 next!	input 1 next operation	
s cec hdmi out y on!	Set hdmi output y power on by cec, y=0~8 (0=all hdmi output)	s cec hdmi out 1 on!	hdmi output 1 power on	
s cec hdmi out y off!	Set hdmi output y power off by cec, y=0~8 (0=all hdmi output)	s cec hdmi out 1 off!	hdmi output 1 power off	
s cec hdmi out y mute!	Set hdmi output y volume mute by cec, y=0~8 (0=all hdmi output)	s cec hdmi out 1 mute!	hdmi output 1 volume mute	
s cec hdmi out y vol-!	Set hdmi output y volume down by cec, y=0~8 (0=all hdmi output)	s cec hdmi out 1 vol-!	hdmi output 1 volume down	
s cec hdmi out y vol+!	Set hdmi output y volume up by cec, y=0~8 (0=all hdmi output)	s cec hdmi out 1 vol+!	hdmi output 1 volume up	
s cec hdmi out y active!	Set hdmi output y active source by cec, y=0~8 (0=all hdmi output)	s cec hdmi out 1 active!	hdmi output 1 active source	

Command Code	Function Description	Example	Feedback	Default Setting
Network Setting				
r ipconfig!	Get the current ip configuration	r ipconfig!	ip mode: static ip: 192.168.0.100 subnet mask: 255.255.255.0 gateway: 192.168.0.1 tcp/ip port=8000 telnet port=23 mac address: 00:1c:91:03:80:01	
r mac addr!	Get network mac address	r mac addr!	mac address: 00:1c:91:03:80:01	
s ip mode z!	Set network ip mode to static ip or dhcp, z=0~1 (z=0 static, z=1 dhcp)	s ip mode 0!	set ip mode:static. (please use "s net reboot!" command or repower device to apply new config!)	
r ip mode!	Get network ip mode	r ip mode!	ip mode: static	
s ip addr xxx.xxx.xxx.xxx!	set network ip address	s ip addr 192.168.0.100!	set ip address:192.168.0.100 (please use "s net reboot!" command or repower device to apply new config!) dhcp on, device can't config static address, set dhcp off first.	
r ip addr!	Get network ip address	r ip addr!	ip address:192.168.0.100	
s subnet xxx.xxx.xxx.xxx!	Set network subnet mask	s subnet 255.255.255.0!	set subnet mask:255.255.255.0 (please use "s net reboot!" command or repower device to apply new config!) dhcp on, device can't config subnet mask, set dhcp off first.	
r subnet!	Get network subnet mask	r subnet!	subnet mask:255.255.255.0	
s gateway xxx.xxx.xxx.xxx!	Set network gateway	s gateway 192.168.0.1!	set gateway:192.168.0.1 (please use "s net reboot!" command or repower device to apply new config!) dhcp on, device can't config gateway, set dhcp off first.	
r gateway!	Get network gateway	r gateway!	gateway:192.168.0.1	
s tcp/ip port x!	Set network tcp/ip port (x=1~65535)	s tcp/ip port 8000!	set tcp/ip port:8000	
r tcp/ip port!	Get network tcp/ip port	r tcp/ip port!	tcp/ip port:8000	
s telnet port x!	Set network telnet port (x=1~65535)	s telnet port 23!	set telnet port:23	
r telnet port!	Get network telnet port	r telnet port!	telnet port:23	
s net reboot!	Reboot network modules	s net reboot!	network reboot ... ip mode: static ip: 192.168.0.100 subnet mask: 255.255.255.0 gateway: 192.168.0.1 tcp/ip port=8000 telnet port=23 mac address: 00:1c:91:03:80:01	

11. Application Example

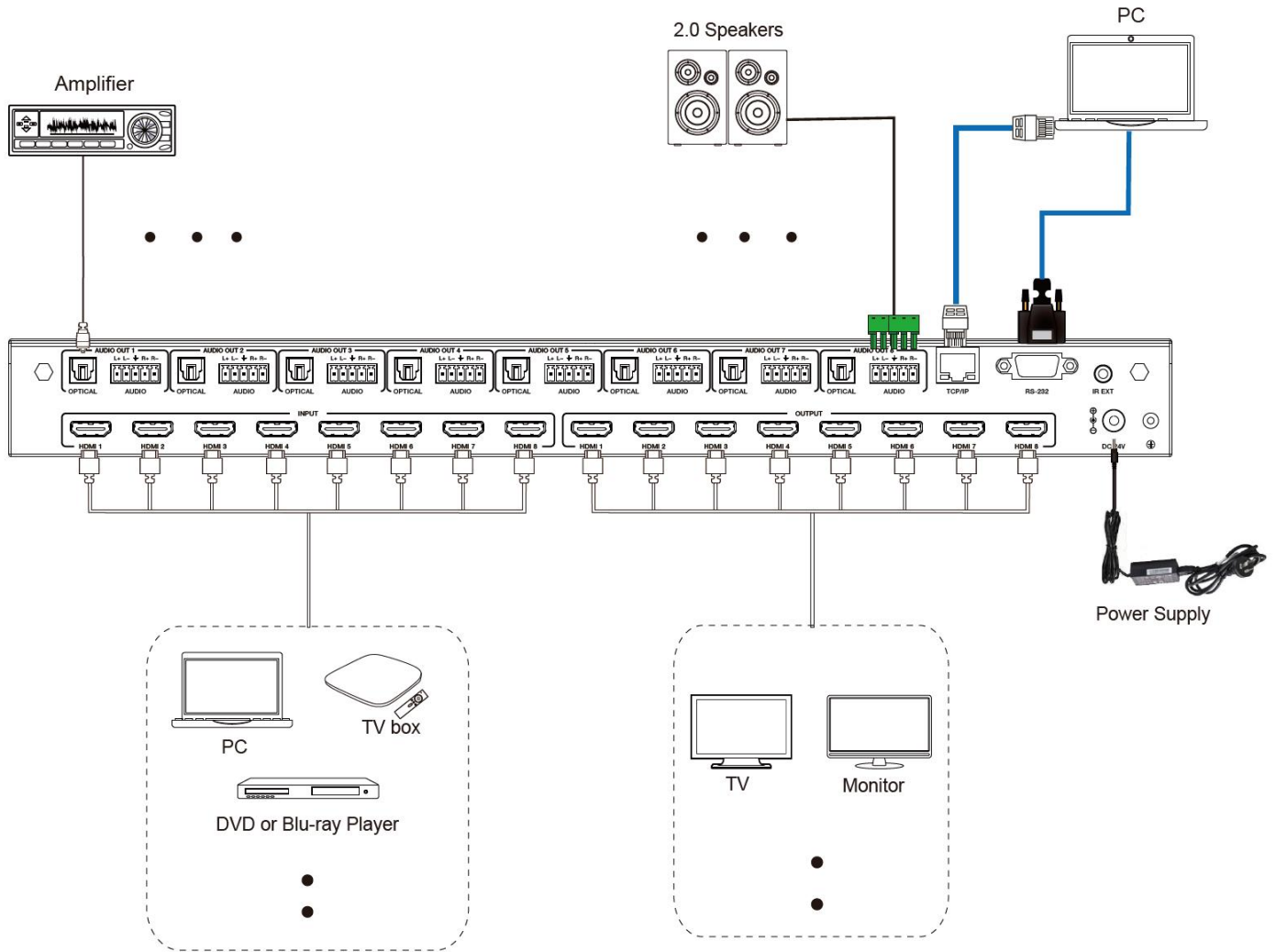

The terms HDMI and HDMI High-Definition Multimedia interface, and the HDMI Logo are trademarks or registered trademarks of HDMI Licensing LLC in the United States and other countries.