

KORG

SOUNDLINK

MW-1608

HYBRID ANALOG/DIGITAL MIXERS

MW-2408

**USER
MANUAL**



Important Safety Instructions

This product complies with IEC62368-1 safety standards. Safety indication label is located on the bottom panel of the unit.

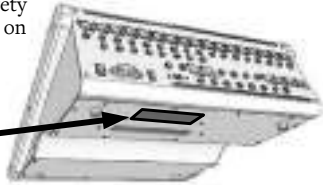

prong. The wide blade or the third prong are provided for your safety. If the provided plug does not fit into your outlet, consult

an electrician for replacement of the obsolete outlet.



The lightning flash with arrowhead symbol, within an equilateral triangle, is intended to alert the user to the presence of uninsulated "dangerous voltage" within the product's enclosure that may be of sufficient magnitude to constitute a risk of electric shock to persons. The exclamation point within an equilateral triangle is intended to alert the user to the presence of important operating and maintenance instructions in the literature accompanying the device.

1. Read and keep these instructions.
2. **Heed all warnings.**
3. **Follow all instructions.**
4. **WARNING:** To reduce the risk of fire or electric shock, do not expose this apparatus to rain or moisture.
5. Do not use this apparatus near water.
6. Do not block any ventilation openings. Install in accordance with the manufacturer's instructions.
7. Do not install near any heat sources such as radiators, heat registers, stoves, or other apparatus.
8. Do not defeat the safety purpose of the polarized or grounding type plug. A polarized plug has two blades with one wider than the other. A grounding type plug has two blades and a third grounding

9. Protect the power cord from being walked on or pinched particularly at plugs, convenience receptacles, and the point where they exit from the apparatus.

10.  Use only with the cart, stand, tripod, bracket, or table specified by the manufacturer, or sold with the apparatus. When a cart is used, use caution when moving the cart/apparatus combination to avoid injury from tip-over.

11. Unplug this apparatus during lightning storms or when the apparatus has been damaged in any way, such as power-supply cord or plug is damaged, liquid has been spilled or objects have fallen into the apparatus, the apparatus has been exposed to rain or moisture, does not operate normally, or has been dropped.
12. **WARNING:** The apparatus must be connected to an AC power output (MAINS) with a protective grounding (earthing) connection.
13. Where a main AC connection (MAINS) or appliance coupler, such as power strip is used as the disconnect device, the disconnect device shall remain readily operable.
14. Only use attachments/accessories specified by the manufacturer.
15. Clean only with dry cloth.

16. This product must be disposed of correctly.



This symbol indicates that this product must not be disposed of with household waste, according to the WEEE Directive (2012/19/EU) and/or your national or regional law. This product

should be taken to a collection center licensed for the recycling of electronic waste and electronic equipment (EEE). The mishandling of this type of waste could have a possible negative impact on the environment and human health due to potentially hazardous substances that are generally associated with EEE. At the same time, your cooperation in the correct disposal of this product will contribute to the efficient use of natural resources. For more information concerning EEE recycling, contact your local city office or your household waste collection service.

FCC Compliance

Supplier's Declaration of Conformity (for USA)

Responsible Party:

KORG USA INC

Address:

316 S. SERVICE RD. MELVILLE, NY

Telephone:

1+ 631-390-6500

Equipment Type:

HYBRID ANALOG/DIGITAL MIXER

Model:

MW-2408 / MW-1608

This device complies with part 15 of the FCC Rules. Operation is subject to the fol-

lowing two conditions: 1) This device may not cause harmful interference; 2) This device must accept any interference received, including interference that may cause undesired operation.

Note: This equipment has been tested and found to comply with the limits for a Class B digital device, pursuant to part 15 of the FCC Rules. These limits are designed to provide reasonable protection against harmful interference in both a commercial and residential installation.

This equipment generates, uses and can radiate radio frequency energy and, if not installed and used in accordance with the instructions, may cause harmful interference to radio communications.

However, there is no guarantee that interference will not occur in a particular installation. If this equipment does cause harmful interference to radio or television reception, which can be determined by turning the equipment off and on, the user is encouraged to try to correct the interference by one or more of the following measures:

1. Reorient or relocate the receiving antenna.
2. Increase the separation between the equipment and receiver.
3. Connect the equipment into an outlet on a circuit different from that to which the receiver is connected.
4. When connecting this mixer to another product use only quality shielded cables.
5. Use AC power outlets (MAINS) that are on a different branch circuit (circuit breaker or fuse), or employ a power filter/conditioner.
6. Consult the dealer or an experienced radio/TV technician for help.
7. Unauthorized changes or modification to this system can void the user's authority to operate this equipment.

Welcome...and thank you!



Greg Mackie founded TAPCO in the 70's to make the first practical band mixers. Then in 1990, he formed the eponymous company truly revolutionized both live and studio recording for cash-strapped musicians and seasoned pros alike. After retiring from that company in 2002, he's been busy designing for others and himself.

A few words from Greg Mackie.

I've been designing mixers for over 40 years. A few years ago, I helped create a compact all-digital mixer. For a while, I used it in my own live mixing, which includes talent shows, open mic nights and three-bands-in-one-night at a club. Here, I had to deal with feedback, groups I'd never mixed before, more feedback, microphone mishandling and timid vocalists, three mics on one act and sixteen on the next...oh, did I mention feedback?

I discovered that the all-digital interface simply could not let me make changes and corrections fast enough — too many menus and scrolling! On the other hand, I loved the equalization, effects, and presets of digital.

SoundLink is my and Peter Watts' hybrid solution superbly interpreted and executed by KORG. It gives you analog's instant control for the emergencies that inevitably happen in live mixing, but with the power of high-quality digital where it counts.



Born in London, UK, Peter worked at Trident Audio for 18 years (10 years as Head of R&D) assembling, testing and designing now-legendary high-end analog studio and mixers. He moved to the USA to join Mackie Designs, staying for 7 years as VP of Engineering and Chief Designer for Digital Mixers and related products. In 2003 Peter founded Stonepower Ltd as an independent professional audio design house, working on projects for numerous brands.

You have made a good choice.

We are glad that you have chosen a KORG SoundLink MS mixer. Here are some of the highlights:

- True hybrid design developed with mixer design legends Greg Mackie and Peter Watts
- 24 x 8 x 2 or 16 x 8 x 2 models
- Peter Watts-designed HiVolt mic preamps, with more headroom than any comparably-priced mixer (+/-16.5V internal voltage on mono and stereo channels)
- Velvet Sound™ A/D & D/A converters with 0.004% THD,
- L/R Monitor, 1/4" and XLR main outs, eight 1/4" Group Outs, four XLR Aux Outs, two 1/4" Musician's Phones outputs linked to Aux 3 & 4, front panel Headphone output, stereo USB output
- Eight mono/four stereo individual output buses (true 8-bus design)
- Unique Musician's Phones Monitor Section gives two musicians individual control of how much of "me" versus the total mix they hear
- Only mixer in its class with Mute Groups to quickly create and recall various input combinations of on-stage musicians
- Mono channels have Peter Watts-derived HI (12k), MID (250 hz - 5k sweepable) and LO (100 Hz) EQ; Stereo channels feature HI, HI MID (2.5k), LO MID (250 hz) and LO EQ
- Digital section includes three each of Peter Watts-designed Compressors, Limiters and Noise Gates, each with editable, recallable parameters
- Three ingenious 9/31-band ParaGraphic equalizer that each address nine bands out of a possible 31
- Twenty of KORG's renowned 32-bit digital effects – 10 at once, with save and recall user settings
- Foot switch control for FX
- Talkback to L/R or to Aux 1-4
- Peter Watts-inspired rack-mount-processor-grade, one-knob Compressor on all mic channels
- Best Automatic Feedback Control of any compact mixer
- USB stereo output/input Input for recording out and backing tracks in
- Optional foot switch
- Super-useful touches such as all-XLR speaker outputs and enhanced Break Switch with 1/8" input
- Silky-smooth, long-life ALPS® faders and rotary controls
- MW-2408 fits in a 19" rack

IMPORTANT! First set correct input levels

Level Setting Procedure... ten simple steps.

This procedure is *so important* that we put it on the pages *before* the Table of Contents, diagrams of various mixer parts or anything else. It's that critical!

Set a channel's **GAIN** (volume) too low and there will be noise (hiss) in that channel, even when no voice or instrument is present.

If **GAIN** (volume) is set too high, the signal will distort and sound scratchy when the singer or instrument gets very loud.

Correctly setting each channel's **GAIN** control achieves the maximum amount of signal "headroom" before distortion and the least possible amount of noise.

You will need:

- Your new mixer
- Sound sources such as a microphone, guitar, drum kit, keyboards, music player, etc. — whatever gear you will be using during a sound mixing session;
- The right cables to hook your sound sources to the mixer. (We go into more detail about connectors later on);
- Monitor speakers or headphones.

Let's begin.

- 1 Plug your SoundLink mixer into a wall socket.

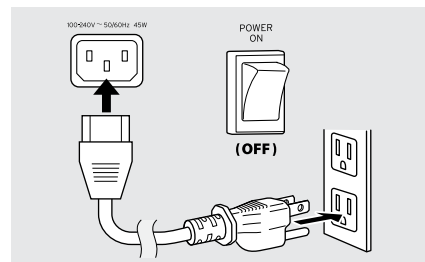

- 2 Connect monitor speakers to the SoundLink mixer rear panel **MAIN OUT (1a)** or **MONITOR OUT (1b)** jacks, or plug headphones into the **PHONES** jack (**1c**).
- 3 Let's start with Channel 1.
- 4 Make sure that Channel 1's **PAN**, **COMP**, and all four **EQ** knobs are set to the center (12 o'clock) position.

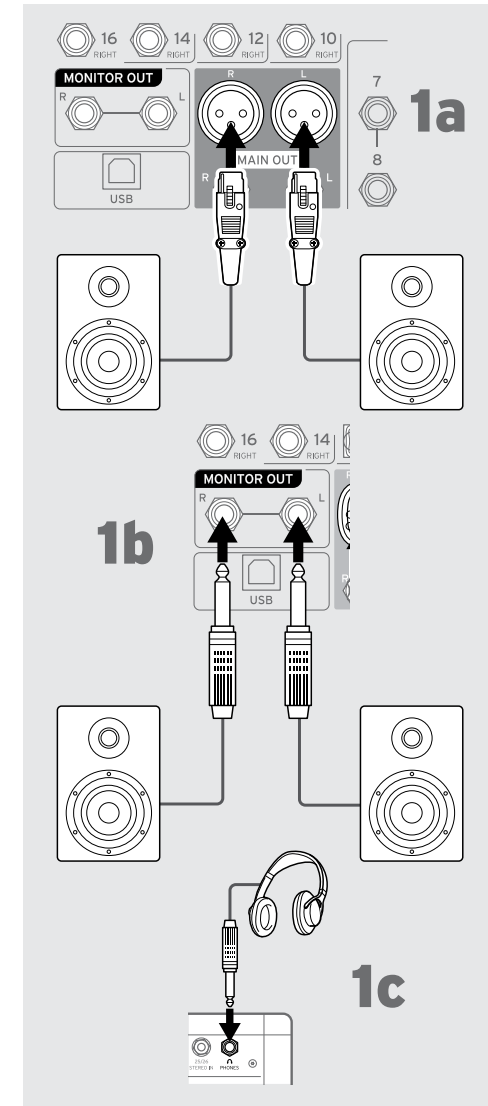
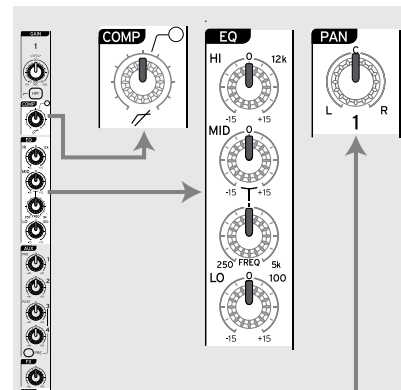

Ten Steps to Level Setting

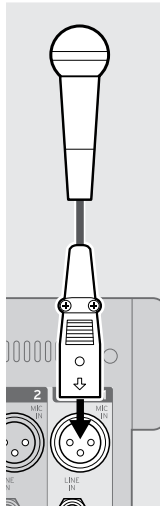

5 Plug a microphone or other audio source into the first channel's rear panel **MIC IN** socket.

6 Turn **ON** the mixer's rear panel **POWER** switch. Then turn on your monitors or their amp.

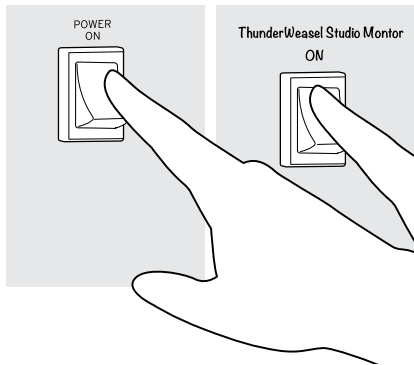

You can check levels at any time by pressing a channel's PFL (PreFader Listen) button. Then make channel level changes as necessary.

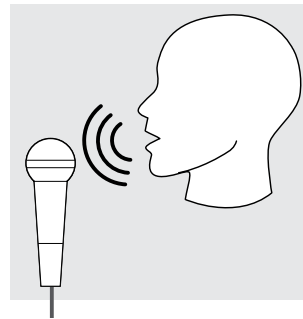

7 Sing into the mic or play an instrument at the volume the musician or presenter will be using during a performance.

8 Press Channel 1's **PFL (Pre Fader Listen)** button. The orange LED just above the button should light up.

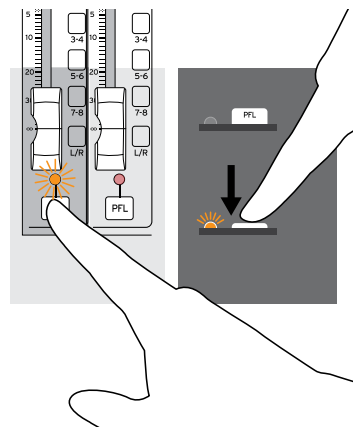

9 While watching the Main Level Display at the right of the mixer, turn Channel 1's **GAIN** knob clockwise until the LED above "0" flickers occasionally... but not very often.

This is the desired range

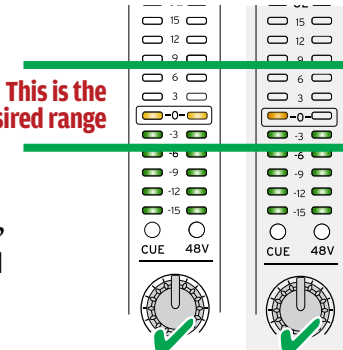

10 Okay. Here's the less than-fun news: *you need to do this procedure for every channel* that you are using for your musical or A/V performance.

As you probably know, this is called a **Sound Check**. Come early to a major concert and you'll witness the same instrument-by-instrument, mic-by-mic procedure being performed.

The good news is, your MW-1608 or MW-2408 is now ready to mix at its best settings with maximum headroom and lowest noise.

Take our word for it: These steps are worth it!

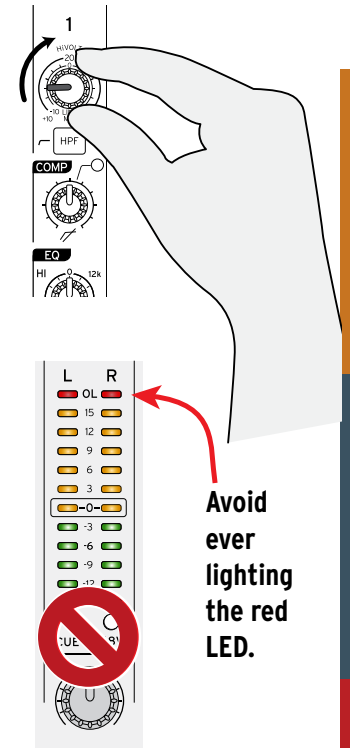
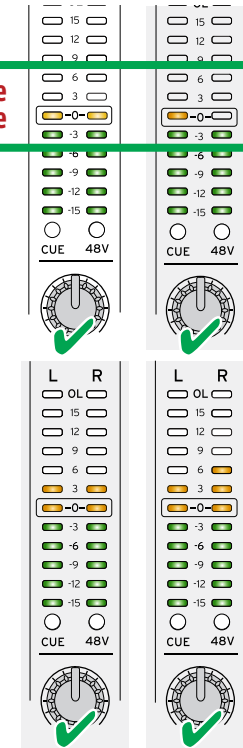

Trying to set levels by saying "Test-ing 1, 2, 3" into the mic doesn't really work. Instead, sing some vocals or play an instrument at a **realistic** level.

Hit a cymbal, tom or kick drum as hard as the drummer will during the performance; jam on that guitar; honk that sax; make sure keyboard output level is set at normal output. You get the idea.

Table of Contents

The nav bars
are clickable.



Hook-up/Back panel

Analog Controls

Digital Controls

If you're a beginner...

...it's a good idea to read through this whole manual. We've tried to use non-techy language, and explain stuff most other manuals don't.

The biggest mistake beginners make is to *not* take advantage of all the time-saving, problem-solving, make-you-sound-better features on their mixer.

Well, the second biggest mistake; the first is not doing proper level setting.

We hope that this manual can help you get the best performance possible. Read on!

If you're experienced...

...SoundLink has some features and twists you don't usually find in mixers at this price point. For the "*Been there, done that*" crowd, we've marked these in the Table of Contents **like this...**

A few words from Greg Mackie.....	3
Why do we start with the back of the mixer?.....	8
Power supply section	9
POWER switch.....	9
Power input connector.....	9
Mono input channels.....	9
Stereo input channels.....	9
USB input / output.....	11
USB In	11
USB Out	11
Foot Switch input.....	11
Talkback input.....	11
Main Out	12
Monitor Out.....	12
Group Out (sub buses).....	12
Aux Out.....	13
Musician Phones	13
Channel 25-26 (or Channels 17-18) and Phones	13
Mono Channel Strips.....	19
Gain Control.....	19
Comp (Compressor) and indicator.....	19
EQ (Equalization), Mono Channels.....	20
Aux Sends.....	22
Aux PRE Switch.....	22
FX Send.....	22
Pan.....	23
Mute button/indicator.....	23
OL (Overload) LED.....	23
-20 (Signal present) LED.....	23
Bus Assign switches.....	23
Channel fader.....	23

Different than Mono Channels	24
Same as Mono Channels.....	24
PFL switch / indicator.....	24
Source Mic / Line (stereo channels).....	24
MID EQ (stereo channels).....	25
A few more tips on equalization.....	25
Further reading about mixing.....	25
Master Control Section	26
Aux Master.....	26
Aux Master AFL buttons and indicator.....	26
Musician's Phones.....	26
A traditional Monitor Mix vs. a better way.....	27
Talkback.....	27
FX Master Section.....	28
Meter section.....	28
STEREO IN knob	28
MONITOR section.....	28
BREAK button/indicator	29
Group Master Section.....	29
MAIN MIX (L/R) fader.....	29
Selecting channels for a Mute Group.....	30
How the band is set up on the mixer.....	30
The "pusha-bunch-'O' buttons" approach to creating a mute group.....	30
MUTE GROUPS TO THE RESCUE.....	31
Un-doing the "pusha-bunch-'O' buttons" approach to creating a mute group.....	31
Program a Mute Group.....	32
"Hard muting".....	33
Creating a Mute Group.....	33
Adding to or subtracting channels from a Mute Group.....	34
Combining Hard Mutes and Mute Groups.....	35
Saving and Recalling Mute Groups.....	36

Digital Effects (DFX).....	37
Selecting the DFX type	37
Applying a Digital Effect.....	38
Editing an effect.....	38
Using the TAP button to set the delay time....	39
Saving a Digital Effects setting.....	39
Recalling a DFX preset.....	40
Gee, they don't sound like effects!.....	40
SoundLink Signal Processing*.....	41
Equalization.....	41
Feedback Suppressor	41
Saving a Dynamics setting.....	44
Recalling a Dynamics preset.....	44
Selecting Narrow or Wide 9-band equalization.....	46
Adjusting 9-band EQ (Wide Mode).....	47
Adjusting EQ Narrow Mode EQ (31 /9-band)..	48
Adjusting (Narrow Mode) Continued	49
Saving Equalizer settings.....	50
Recalling an Equalizer Setting.....	50
Recalling an Equalizer Setting (continued) ...	51
Feedback Suppressor: Routing options.....	52
Locking feedback suppressor state.....	53
Global menu.....	54
Saving a Global Scene	54
Recalling a Global Scene	55
Other GLOBAL options.....	55
More on Factory Reset (restoring the factory default settings).....	57
Reference	
Specification.....	58s
Block Diagram.....	60
Settings that can be saved.....	60
Rack mounting (MW-2408 only).....	64



Hook-up/Back panel

Analog Controls

Digital Controls

Hooking up your SoundLink mixer.

First things first.

The only difference between the SoundLink MW-2408 and the MW-1608 is the number of channels.

The controls, functions and

connections are identical. All the drawings and photos in this manual are of the MW-1608 because this PDF fits small screens better

Why do we start with the back of the mixer?

Because hooking stuff up is the first thing you're going to want to do. And most all of the connections are on the back

We'll start with a guided tour of the SoundLink back panel; then some sample hook-ups for various applications.

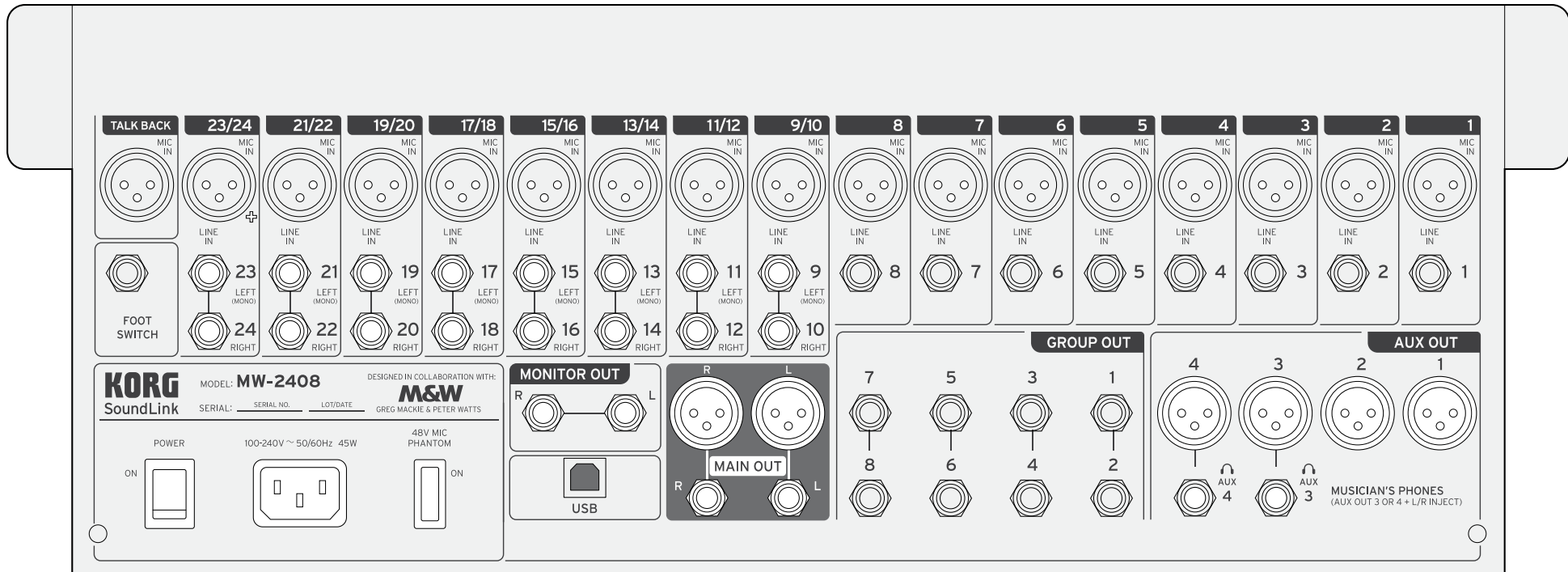

Hooking up your SoundLink

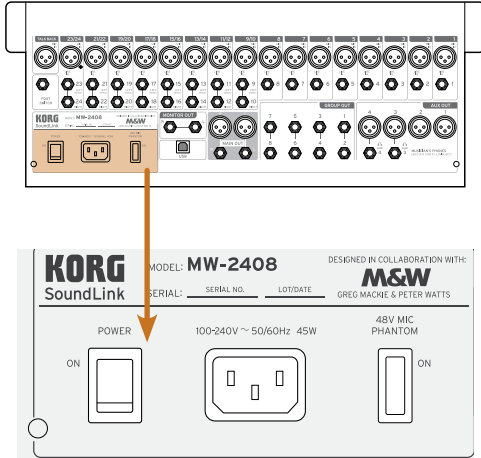

Power supply section

POWER switch

Turns this unit's power on (ON) or off.



Turning the power off and then immediately on might cause malfunctions.



Wait at least five seconds between operations of the power switch.

Power input connector

Connect the included power cord here. First connect the power cord to your SoundLink, and then plug the power cord into an AC outlet.

48V MIC PHANTOM switch

Turns the PHANTOM power on/off. Turn this on if you're using a device that operates using phantom power, such as a condenser mic or a direct box.

If this is on, the 48V indicator just below the L/R meter is lit, and DC+48V is supplied to the MIC IN (XLR jack) of each input channel.

Before turning phantom power on/off, reduce the GAIN knob or fader of each channel to 0 (-∞). The noise that occurs when phantom power is turned on/off might be amplified to output a high-volume noise that could damage your hearing or make a device malfunction.



When turning phantom power on, make sure that no electronic external device is connected to a mic input jack. Failing to observe this precaution might cause an external device to malfunction.



Do not connect or disconnect a channel's MIC jack immediately after turning phantom power off. Doing so may cause a malfunction.

Mono input channels.

The balanced mono XLR MIC IN jacks (round ones with three pins in them) are for hooking up either condenser or dynamic microphones. Behind those input sockets are our HiVolt microphone preamplifiers with exceptional headroom and clarity.

The balanced 1/4" LINE IN inputs are for mono (1-channel) components such as guitar direct boxes.

Stereo input channels.

Only the 1/4" LINE IN jacks are actually stereo. They can be used for keyboards, drum machines, and audio/video

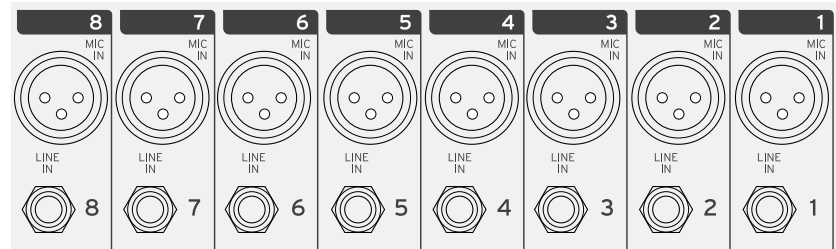
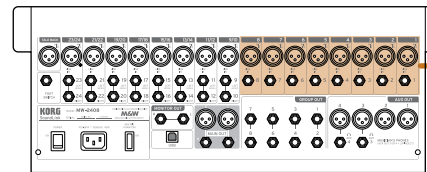

Hooking up your SoundLink

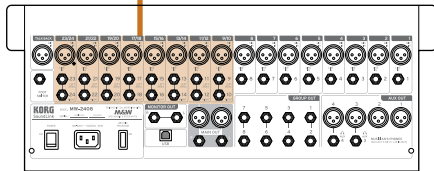
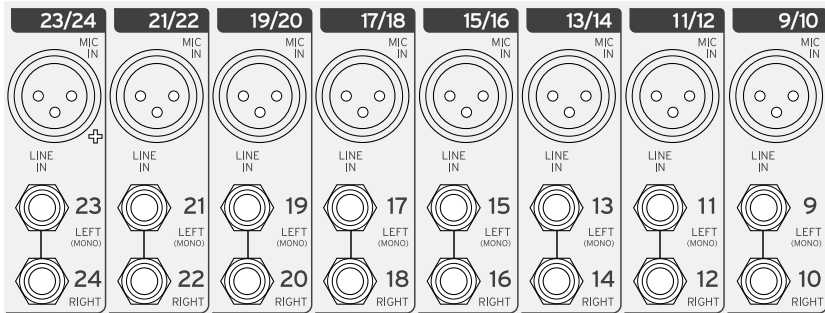

devices such as DVD players or feeds from a laptop (the balanced mono XLR **MIC IN** jack on each stereo channel is for connecting a mono microphone only).

The stereo **LINE IN** jacks are marked **LEFT (MONO)** and **RIGHT**. If you are only connecting a mono input, use the **LEFT (MONO)**.



Mic In and Line In jacks on these channels **CANNOT** be used at the same time.

How do stereo input channels know if they're being sent a mono or stereo input? You "tell them" via the **SOURCE MIC/LINE LINE** button on each stereo channel.

In the **LINE** button **up** position, the channel defaults to mono microphone input; press **LINE** and the channel is ready to receive left and right components of a balanced stereo input.

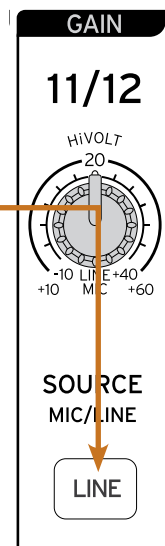

Balanced versus unbalanced: what's the deal here?

When you're just getting into pro sound, you hear these phrases batted around a lot. They represent the two kinds of audio connectors and cables you're going to encounter. There's a big difference.

An unbalanced cable has two conductors – a signal wire and a ground wire. You can easily

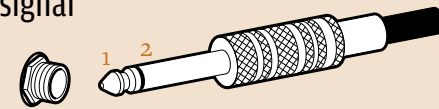

identify an unbalanced cable by its connectors because each wire requires only two conductors at the connector. A standard **TS** (or "tip-sleeve") guitar cable an unbalanced cable: so is a

standard RCA cable used for many audio/video components such as DVD players.

An unbalanced cable does a decent job of rejecting noise over short, but unfortunately, the wire itself also acts like an antenna and picks up noise in

long runs. Unbalanced cables

should not be more than about-20 feet (4-6 meters) in length, especially when used in noisy environments and with signals that are medium level to begin with, such as those from keyboards or MP3 devices, etc. The connector on the end of an unbalanced 1/4" TS (Tip-Sleeve) jack has **two** sections.

A balanced cable has three conductors in the connector and three wires in the cable. Because



Hooking up your SoundLink

of this, balanced cables can support much longer cable runs. Even shorter runs will

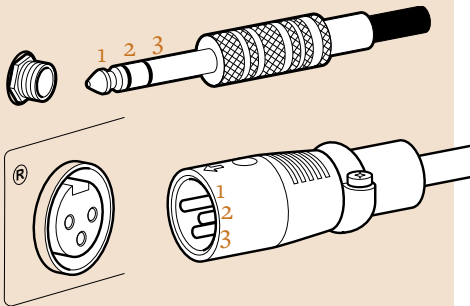

often use balanced wiring to protect against noise.

In a pro sound system, wiring for microphones, and the interconnect cables between active speakers, signal processors, and amps, etc., are typically balanced. Standard connectors designed for use with balanced signals are XLR and **TRS** (Tip-Ring-Sleeve).

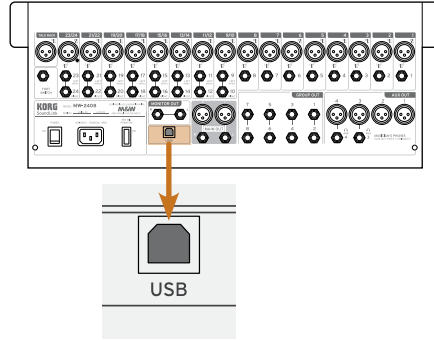

USB input / output.

This port is used to input and output USB audio. (44.1/48 kHz, 16/24-bit)

Connect it to a PC/MAC or an iOS device (e.g., iPhone/iPad) with a USB 2.0 connection.

- This operates with Windows®, Mac® OS, or iOS default drivers.
- If you are using an ASIO-compatible application on Windows, install the KORG Basic Audio Driver which is available from the KORG website.
- To connect to an iPhone/iPad that is equipped with a Lightning connector, you will need a Lightning to USB 3 camera adaptor. When connecting an iPhone/iPad, we recommend that you enable "airplane mode."

USB In

The signal that is input from the connected device is sent to the right-most stereo input channel: Channels 23 & 24 on the MW-2408; Channels 15 & 16 on the MW-1608.

The signal is input *before* the channel EQ. You can use the channel EQ to adjust the tone.

USB Out

This is sort of a digital duplicate of the **MAIN OUTPUT** output jacks. The left/right Main out is sent to a laptop, tablet or cell phone. is output to the connected device.

Use the **MAIN MIX (L/R)** fader to adjust the output level.

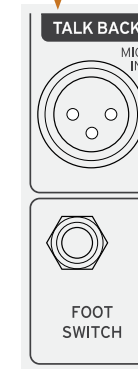
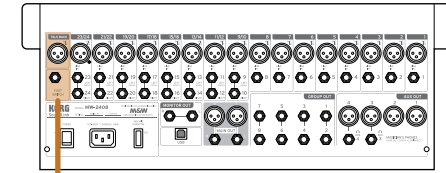

Foot Switch input.

When you plug a foot switch into this jack, you can make announcements to the audience, yell at the band members, tell bad jokes, etc.

We recommend a KORG PS-1 or PS-3 foot switch.

Talkback input.

Plug a dynamic mic into this jack for giving instructions to musicians or presenter on stage, or to make general announcements to your audience / congregation.

Hooking up your SoundLink

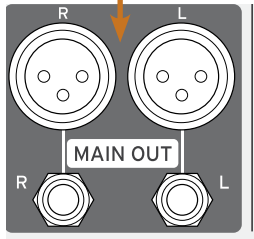
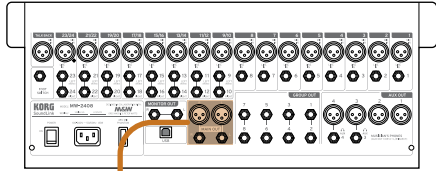

Main Out.

These are your SoundLink's main outputs

for connecting to main PA loudspeakers or power amplifiers. Use the main L/R fader to control the volume output.

 You can use both the XLR and 1/4" TRS outputs at the same time. In other words, four total outputs.

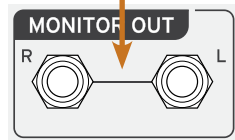
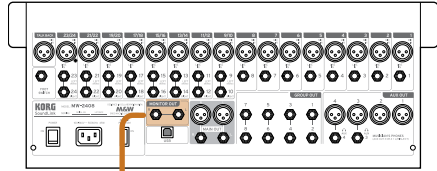

Monitor Out.

Connect these to your

studio monitor (or amps powering your passive monitors) if you are using the SoundLink in a studio situation. Use the **MONITOR** knob to adjust the level.

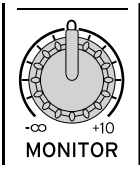

Normally, this output if fed by the **MAIN L/R** bus. When the AFL/PFL function is enabled, this outputs the signal of a specific channel or bus.

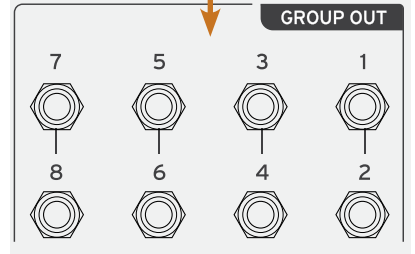
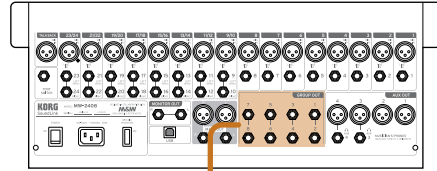

Group Out (sub buses).

Bus, sub group, or sub bus are all names for a path along which you can route one or more audio signals to a particular destination. They are "*mixers inside your mixer*" and are the reason SoundLink mixers are called "8 bus".

Sub Groups (sub buses) are extremely useful for organizing and controlling multiple channels from one fader. Let's say you have three back-up singers, each with their own mic input. To control the level, you would need

to simultaneously move three faders in unison.

Instead, you can route the singer channels to a sub group titled "*Back Up*" by selecting one of Bus Assign buttons next to each of the vocal faders (we picked 3-4).

Now all three vocal channels will be routed into Sub Group 3-4, and controlled by the Sub Group Mix 3-4 fader. Press the **SUB GRP ASSIGN TO L/R** button and control its level in the overall mix with one fader.

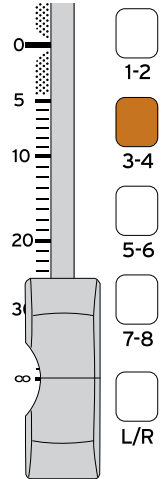

SUB GRP ASSIGN TO L/R



Hooking up your SoundLink

In review, to build a Sub Group:

- 1 Use the small buttons to the right of the channel faders to pick which channels you want in your Sub Group. Press the same button on each channel.

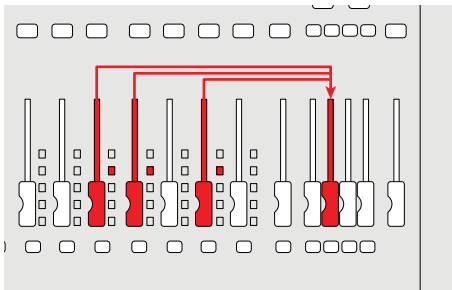

That routes the channels' signals to the Sub Group bus you've chosen.

- 2 If you have a special purpose for the Sub Group, use the **GROUP OUT** jack on the back to send it to a subwoofer, balcony fill, extra monitor, etc

- 3 If you want to add the Sub Group to your main L/R mix, press one of **Sub Group Assign to L/R** buttons.

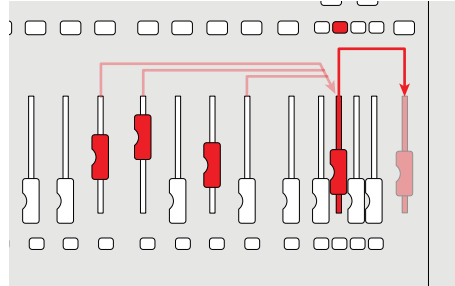

This is also especially useful for drums that are mic-ed with lots of microphones. Six mics; one fader. But we digress.

Among other tasks, the **GROUP OUT** jacks are useful for recording. You can distribute SoundLink's 16 or 24 inputs into 8 outputs fed to an audio/digital interface.

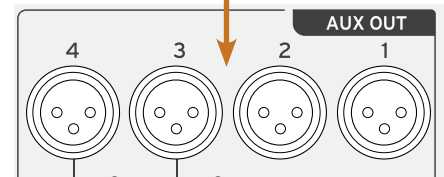
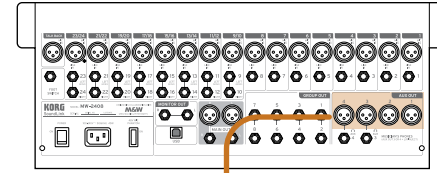

Aux Out.

These balanced XLR outputs are used to send signals to the performers' monitor speakers, in-ear monitors or to an external effect processor.

Create up to 4 **AUX** mixes using the **AUX** controls on each channel strip. There is more explanation further on in this manual.

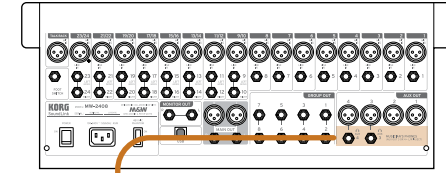
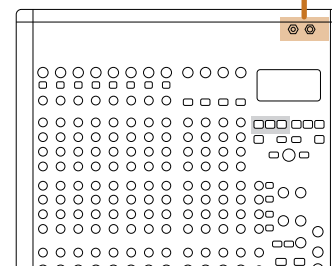

Musician Phones (AUX OUT 3 OR 4 + L/R INJECT)

This is a unique Greg Mackie feature that lets two musicians perfect their monitor mixes without having to upset the AUX setting of all the channels. Described in detail farther on.

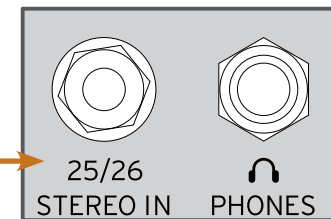

Channel 25-26 (or Channels 17-18) and Phones

1/8" input for MP3 players. 1/4" jack for headphones.

If the phrase “*Your results may vary*” ever fit somewhere, it’s here.

These four hook-up examples are just that: examples.

They are intended to show various options that are possible with Sound-Link Chances are you won’t use every input and output like we have shown. But you could.

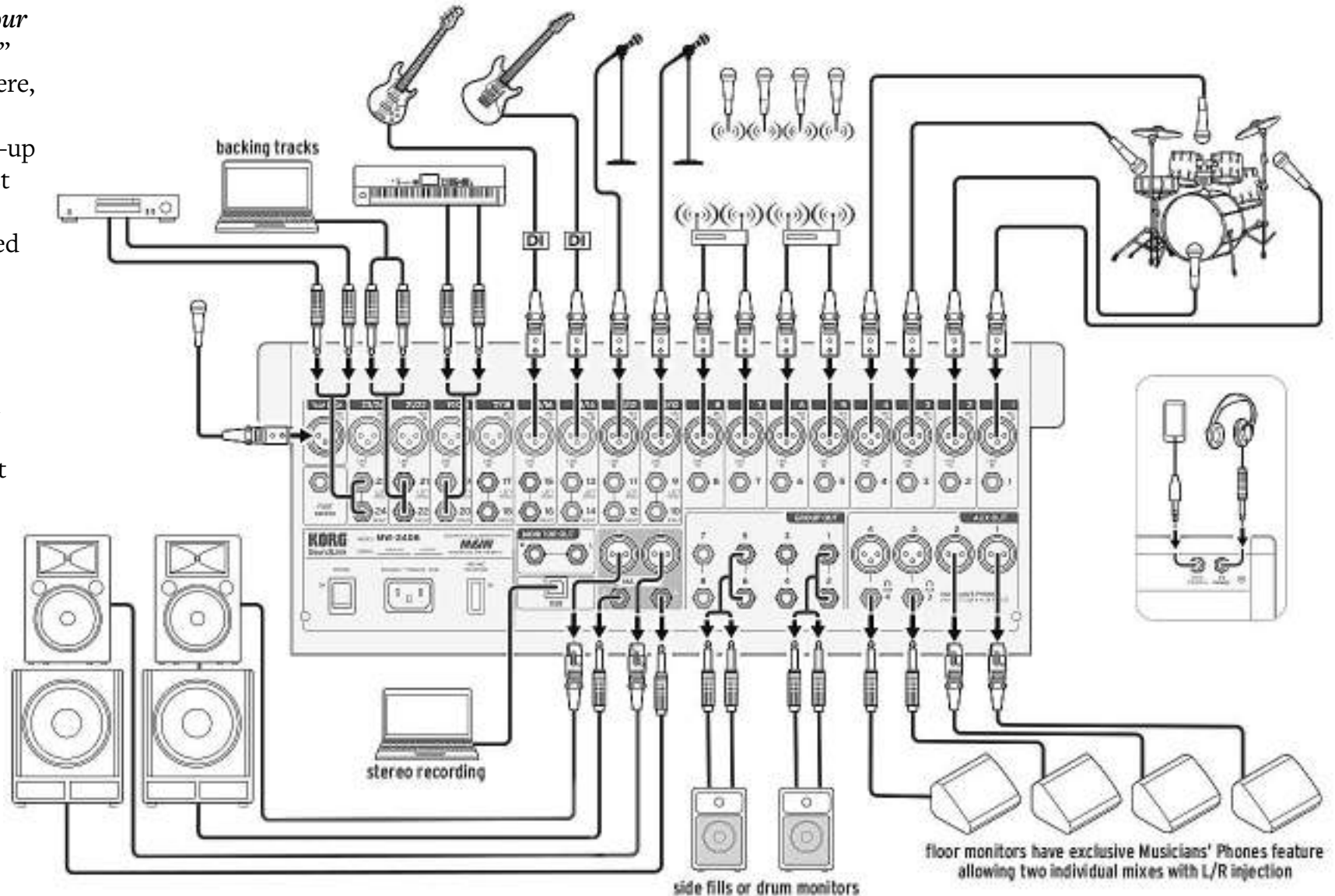

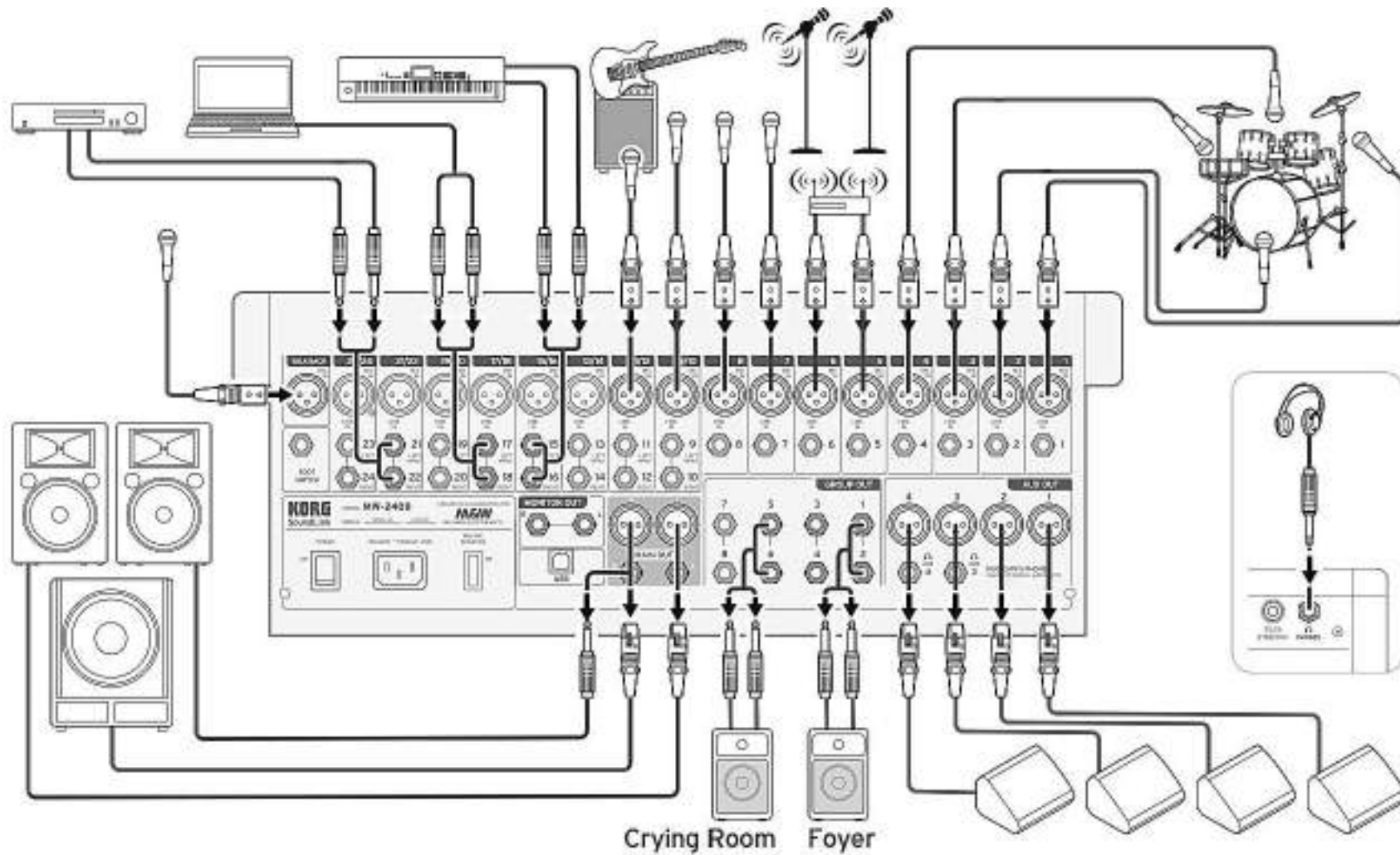

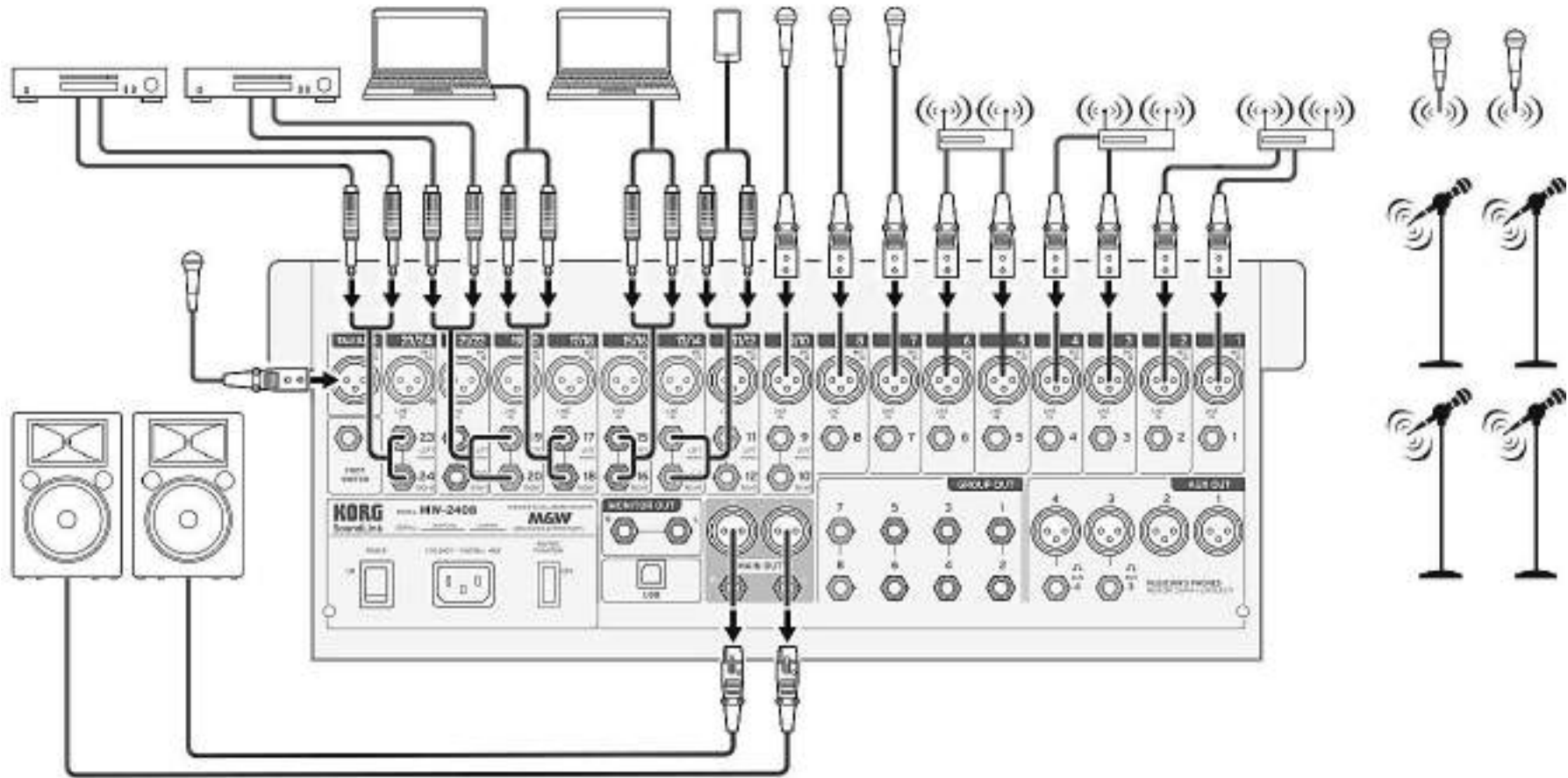

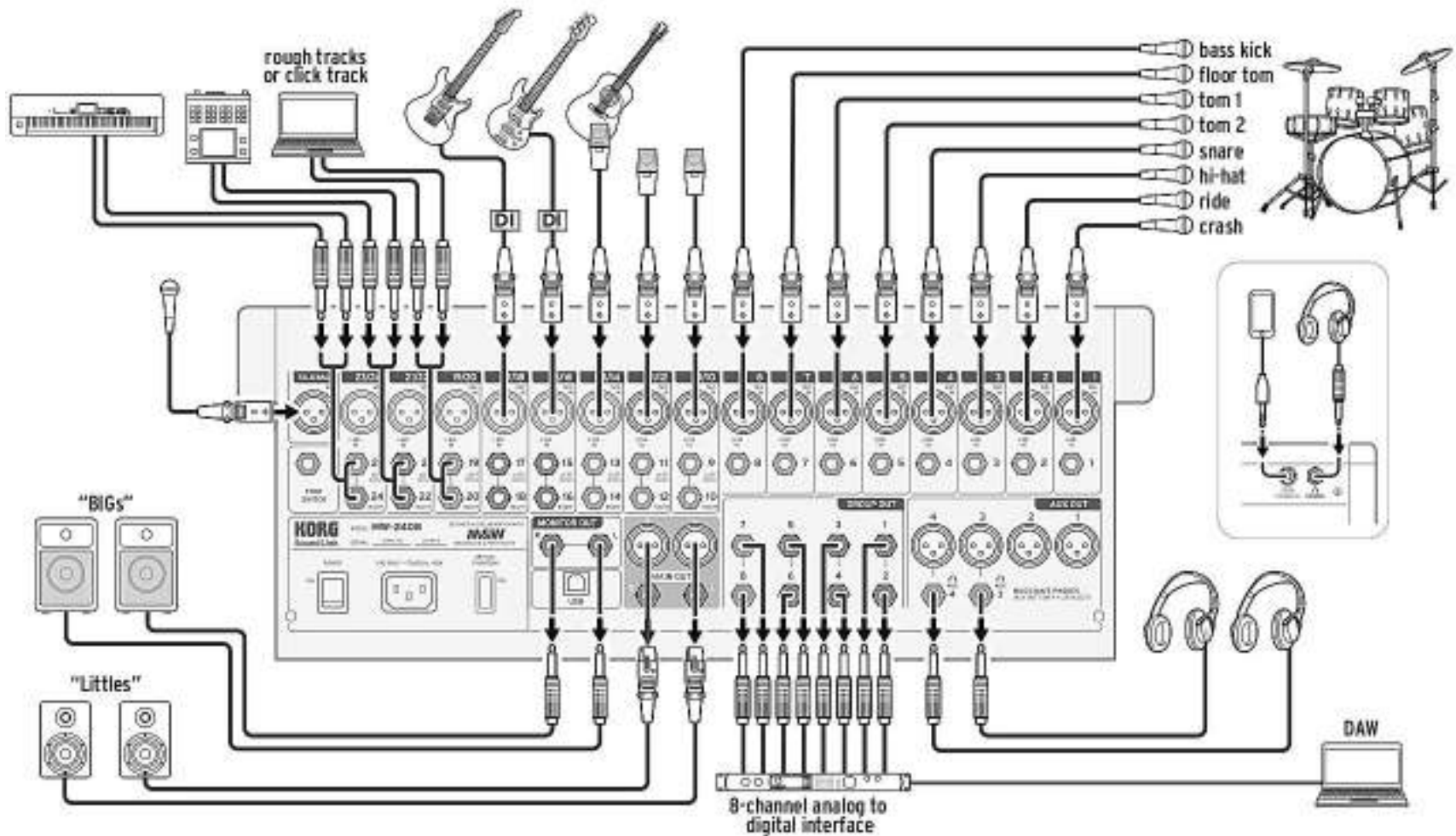

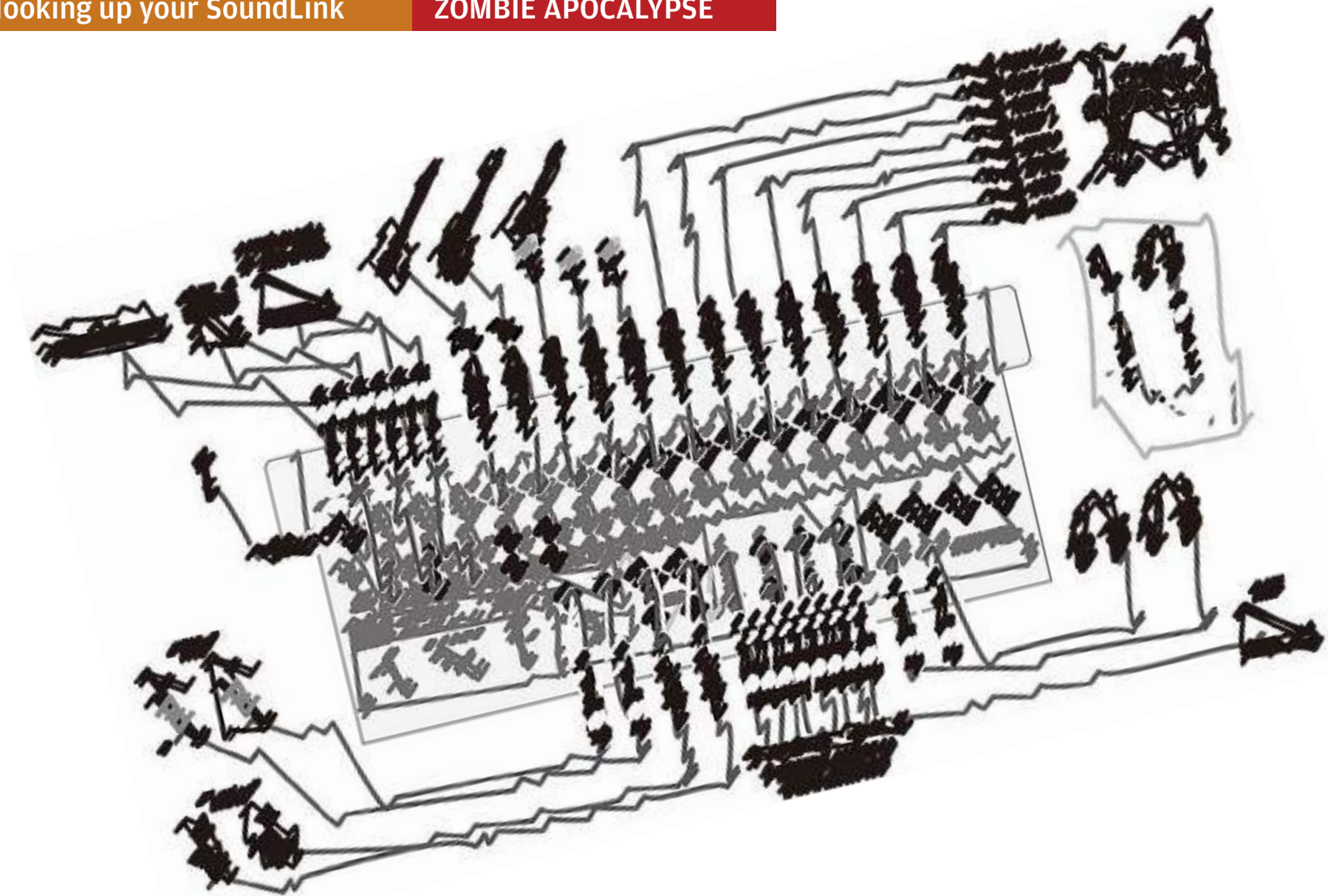

Analog Controls

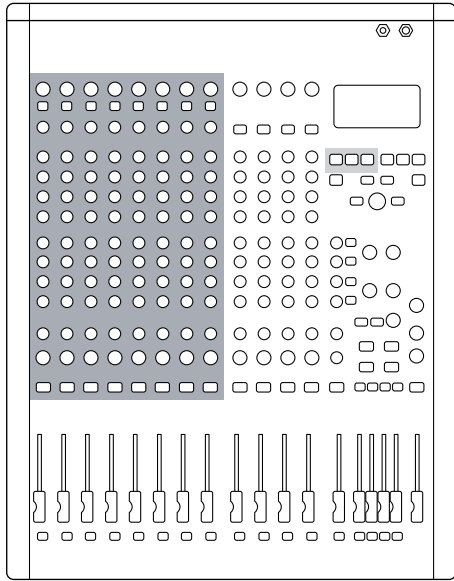

Mono Channel Strips.

All these massed knobs and buttons makes the top of a mixer look somewhat like a Boeing 747 airplane cockpit. But never fear. It's more simple than it looks. Each strip is the same controls repeated in long, tall rows.

With the exception of the fader, you will probably set the controls on each channel strip *just once* before your event (during

the sound check when you do the all-important Level Setting procedure.)

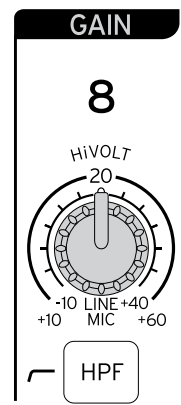

Gain Control.

We've already covered this control somewhat in the Level Setting Procedure, which is its primary use. The rotary control sets the level of the signal

entering the channel. For weak signals, you turn it clockwise; overly strong signals, counter-clockwise. You get your cues from the Main L/R meter levels. Stay around 0dB.

HPF (High Pass Filter)

The High Pass Filter, also called a Low Cut Filter, reduces frequencies under 100Hz (lowest bass). There are a lot of reasons to do this.

All have to do with cutting out “rumble”. Rumble happens through bad mic handling, resonance from a flimsy stage, trucks driving by, air conditioning rumble, wind noise if you're performing outside, herds of stampeding elephants, among other things.

Rumble can suck a lot of power from your PA system. Even if your system is capable reproducing under-100Hz sound, it's generally boomy, unpleasant and muddles your overall PA sound. If your system doesn't do well reproducing ultra-low frequencies, **HPF** lets the PA sound better above 100Hz.



While helping edit this manual Greg said we were being too gentle. According to him HPF should be used **ALL THE TIME on ALL CHANNELS** except low bass stuff such as kick drums, bass guitar, etc.

Comp (Compressor) and indicator.

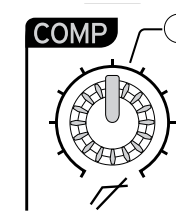

Think of the Compressor as an automatic volume control. Until recently this incredibly

useful tool was not available on analog mixers. We didn't invent “one-knob” compression, but we think we did a better job of it.

Compression is the process of lessening the dynamic range between the loudest and quietest parts of an audio signal. This is done by reducing the louder signals.

It is truly useful on vocal and bass guitar.

Consider the example of a timid lead vocal where some words and phrases are sung more quietly or mumbled. A “normal” fader setting will “lose” the vocalist when they get quiet.

But if you raise the level so that

Analog Controls

the mumbled syllables come though, the rest of the vocal will be overwhelming. No single fader setting gives a good balance because the difference between the highest and lowest signal levels (the "dynamic range") is too large.

Compressors remedy this by reducing a sound's dynamic range: compression reduces the level differences between the quieter mumbled and un-mum-

more closely – an automatic volume control.

A similar trick works for vocalists who have a *consistent* dynamic range. Compression can "raise" them in the mix without having to increase their actual volume.

Compression is also useful for presenters and pastors who speak in a normal voice most of the time **BUT SOMETIMES SHOUT!!!!**, and for mic-ing drums where compression can add "punch".

Note that there is also a *digital* Compressor function that works with AUX 1, AUX 2 and main L/R and has several variable parameters. We cover that further on.

Without compression, wide swings in dynamics.



Compression levels things out.



bled words, making it easier to find a single fader setting that works. The compressor does this by turning down (or compressing) the louder signals so that they match the quieter signals



Greg's mixes-almost-every-weekend advice on equalization: Find the problem areas and **CUT** as needed. Then consider boosting. Otherwise you "chase your tail".

EQ (Equalization), Mono Channels

Equalization is another name for "tone control". But EQ is a lot more sophisticated on Sound-Link mixers than tone control is on a car stereo or MP3 player.

Both mono and stereo Sound-Link channels split the frequency range into three parts: Hi, Mid (midrange) and Lo.

Every instrument covers a broad range of frequencies.

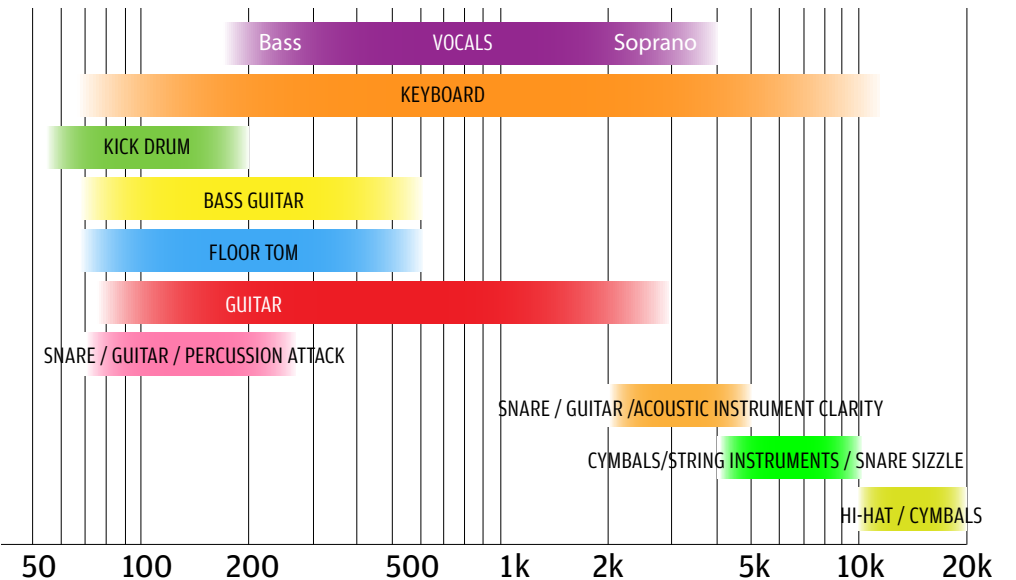
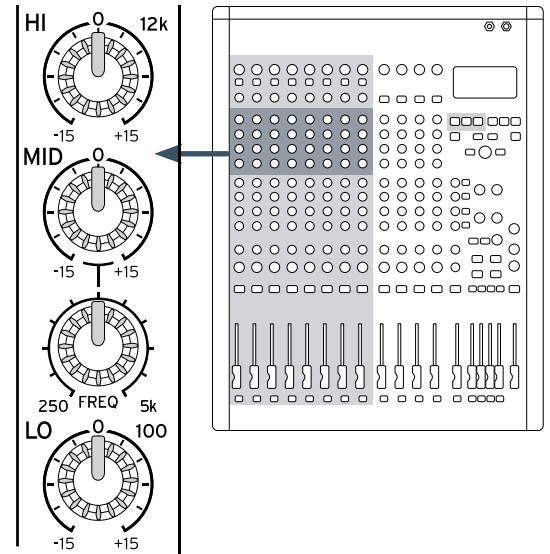

Analog Controls

Bass guitar, kick drums, etc. cover the low end. Vocals sit in the midrange. The cymbals of a drum kit will carry the high-end sizzle. Other instruments like piano and acoustic guitar provide low-mid warmth.

Since most instruments cover a wide range of frequencies, it's nearly impossible to settle on a single EQ control to represent an instrument, but rather a range. Another way to approach EQ is by the effect that various frequency ranges affect instruments' tone, shown in the chart below.

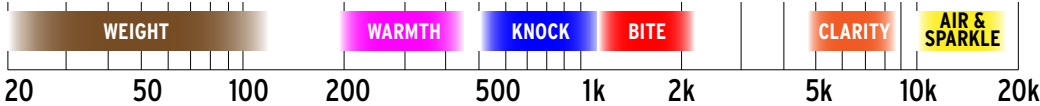

To quote Izotope, a company we really trust (<https://www.izotope.com/en/learn/principles-of-equalization.html>) "Remember that equalization is a problem-solving procedure. A good

approach to equalization is to listen carefully to the soloed track and come up with a list of things you might want to improve or correct. "Always keep your equalization boost/cut at a reasonable level. As a general rule, avoid cutting or boosting by more than 6 dB unless absolutely necessary. If for some reason you see that some of your EQ settings go over this limit try to question why and see if there is a better solution to the problem such as mic placement. "Also keep in mind that you will have to make more small adjust-

ments every time you add tracks to the mix since the frequencies and respective ranges of the other instruments affect the way an instrument sounds. "As a general rule, it is always

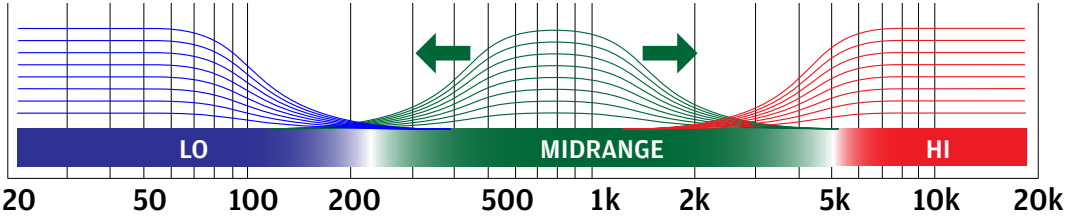

better to cut than to boost, mainly because the human ear is more used to a reduction than to an augmentation in intensity of frequencies."

Above is the frequency distribution of SoundLink mono channel EQ.

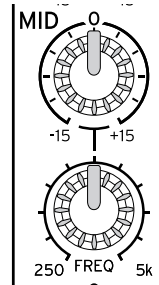

There two controls for MID? Because they adjust different things: One knob for amount ($\pm 15\text{dB}$), and one knob for FREQ (frequency). Its center frequency can be moved anywhere from 250Hz to 5,000Hz which makes it much more useful. At 250Hz, it can work on the tone of guitar,

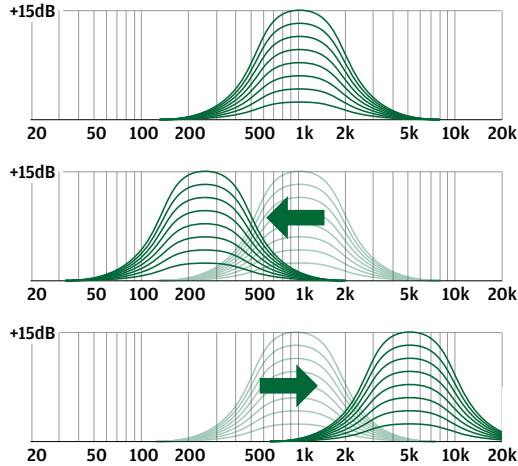

upped bass guitar, percussion, low men's voice, etc.

At 1,000Hz, it's right in the middle of the vocal range

At 5K, you can enhance or reduce acoustic guitar, women's vocals, and percussion such as snare, high-hat etc.

Analog Controls

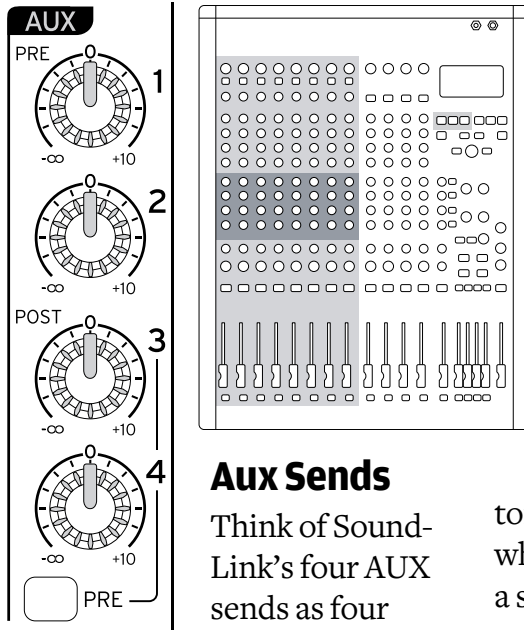

Aux Sends

Think of SoundLink's four AUX sends as four extra mixers. You

can add a portion the channel strip's signal into one of four separate buses and then route those "mixes" to various places. The most common use is to create monitor mixes for the musicians. You can add whatever combination and amount of various channels and then route this mix through an **AUX MASTER** level control and through one of

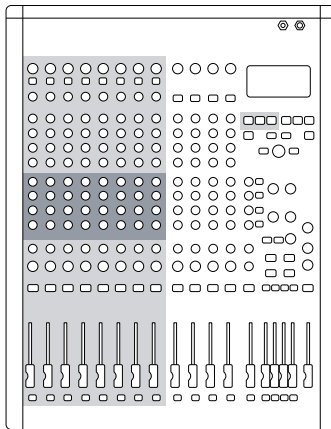

the **AUX OUT** sockets to floor monitors or in-ears.

AUX 1 and 2 are "*pre-fader*". A pre-fader AUX send routes the signal out of the mixer **BEFORE** it passes through the channel fader. You can move the volume fader to your heart's content but it's not going to affect the outbound volume.

Pre-fader is best for monitor mixes. If music is faded down when a presenter is speaking or a singer is reading scripture or speaking, the monitor volumes for the musicians don't change — they still hear everything they need. Plus level does not change for fader moves, avoiding feedback in the monitor system.

A **post-fader AUX** send routes the signal out of the mixer **AFTER** it's gone through the fader. If you move the volume fader up and down, that **AUX** send volume goes up and down, too. Use

post-fader **AUX** for on-air broadcasts, assisted listening, church crying rooms and foyers, club and restaurant lobbies and restrooms, and stereo recording devices via SoundLink's USB out. In the case of stereo input, the left and right signals are mixed and sent to the AUX bus.

You can also use AUX 3 as Left and AUX 4 as right to create an analog mix output.

AUX 1 and 2 are always **PRE**-fader. For **AUX 3 and 4**, you can use the **PRE** switch to select either **PRE** or **POST**

Aux PRE Switch.

See above.

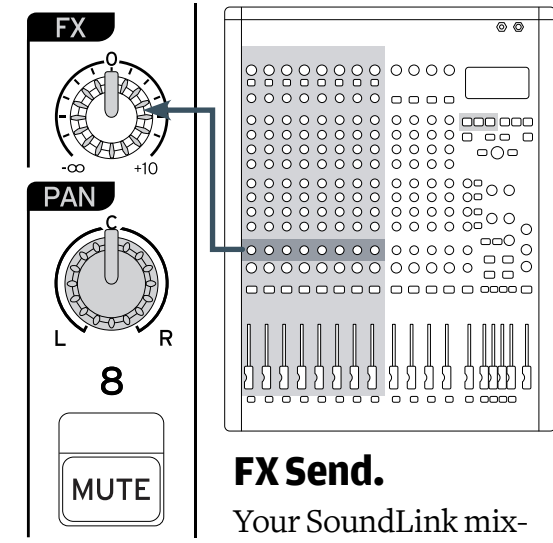

FX Send.

Your SoundLink mixer has 20 extremely

realistic effects, each savable and recallable; each with adjustable parameters.

The **FX** control determines the amount of the channel signal that is sent to the **FX** bus. The **FX** Send is always post-fader

Analog Controls

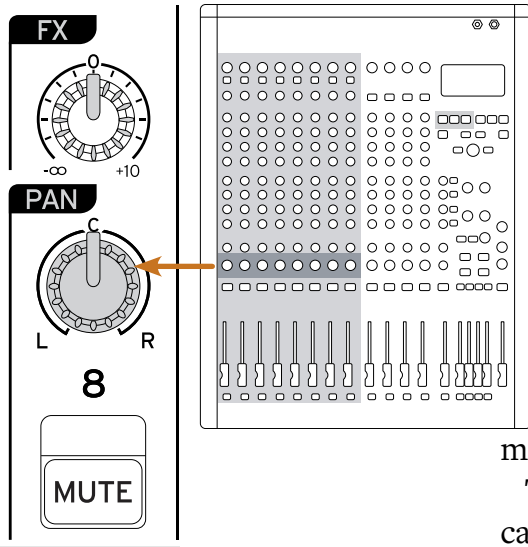

Pan.

On a car stereo, this would be referred to as the BALANCE control. **PAN** adjusts the left/right balance of the channel's sound in the main mix.

Mute button/indicator.

Enables/disables the channel's mute function. In other words, it excludes the channel from the mix.

If **MUTE** is enabled, all signals being sent to **AUX**, **FX**, and the buses specified by the assign switches are all muted.

The **PFL** function can always be used, regardless of the mute setting.

When the mute function is enabled, the indicators are lit as follows.

- Red: Muted by the channel's MUTE button
- Orange: Muted by the MUTE GROUP function or the BREAK function

While the **MUTE** button is a standard feature on small mixers, we have seriously enhanced it with *Mute Groups*. See page 30 (*Mute Groups*) for a complete

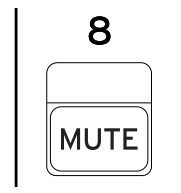

explanation of this extremely useful function

OL (Overload) LED.

This indicator lights when the channel's input signal gets within 3dB of clipping level. *Clipping* is a term for a signal that exceeds that capability of the internal circuitry, resulting in audible distortion — just what you try to avoid by Level Setting during sound check.

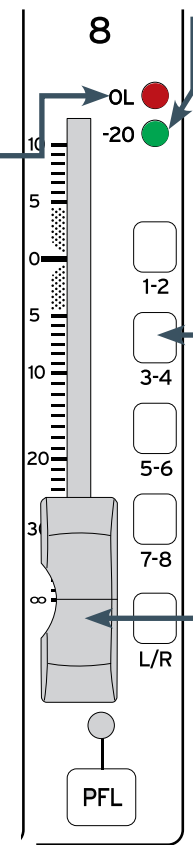

-20 (Signal present) LED.

When this LED flashes or lights continuously, the channel is receiving a signal of at least -20 dB. It's a good way to see if whatever is connected to the channel input is actually making sound.

Bus Assign switches

If you want to create a submix, you press one of more of these buttons. That sends the channel's signal to a **SUB GROUP MIX BUS** as covered on page 12.

Channel fader

Adjusts the output level of the signal that is input to the channel. If a channel is not being used reduce the fader to ∞ (off) to avoid adding unwanted signals to your mix.



The mic preamp input level could be set at the edge of clipping but not actually clipping. BUT, if you boost EQ — particularly low EQ — it adds more gain...and the channel will distort- The OL indicator reads the output of the mic preamp AND the output of the EQ section.

Analog Controls

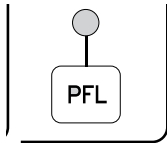

PFL switch / indicator

Enables (—) or disables (■) the

PFL (pre-fader listen) function.

If this button is enabled, the signal before adjustment by the channel fader (“pre-fader”) is output sent to the **PHONES** jack and the **MONITOR OUT** output jacks.

When in the Enable position, the indicator is lit.

Stereo Channels • Same and Different

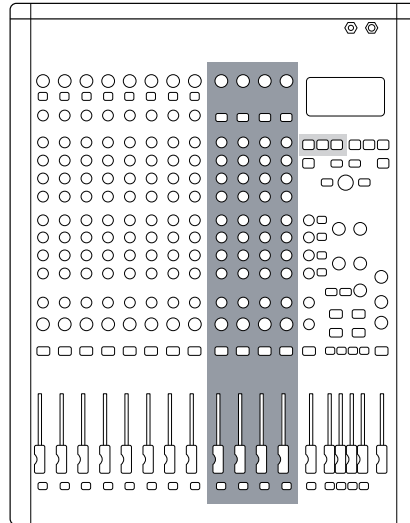

Stereo channels have a few different controls and many identical ones.

Different than Mono Channels

- TRS stereo Line inputs
- Mic/Line switch
- No Compressor function
- 2-band **fixed** MID EQ
- Shared channel controls (9/10, 11/12 combined etc.)

Same as Mono Channels

- Input Gain
- Hi Eq
- Lo Eq
- Aux Sends
- FX
- Pan
- Mute
- OL & -20 LEDs
- Bus Assign switches
- 60mm fader
- PFL switch

13/14

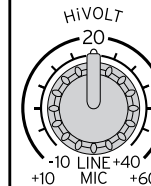

SOURCE
MIC/LINE

LINE

Source Mic / Line (stereo channels).

Switches the channel setting according to the input jack(s) used.

Set this to **MIC** (■) if using the rear panel **MIC IN** jack.

Set it to **LINE**

(—) if using the **LINE IN** jack(s).



The MIC IN jack and LINE IN jack cannot be used at the same time.

Analog Controls

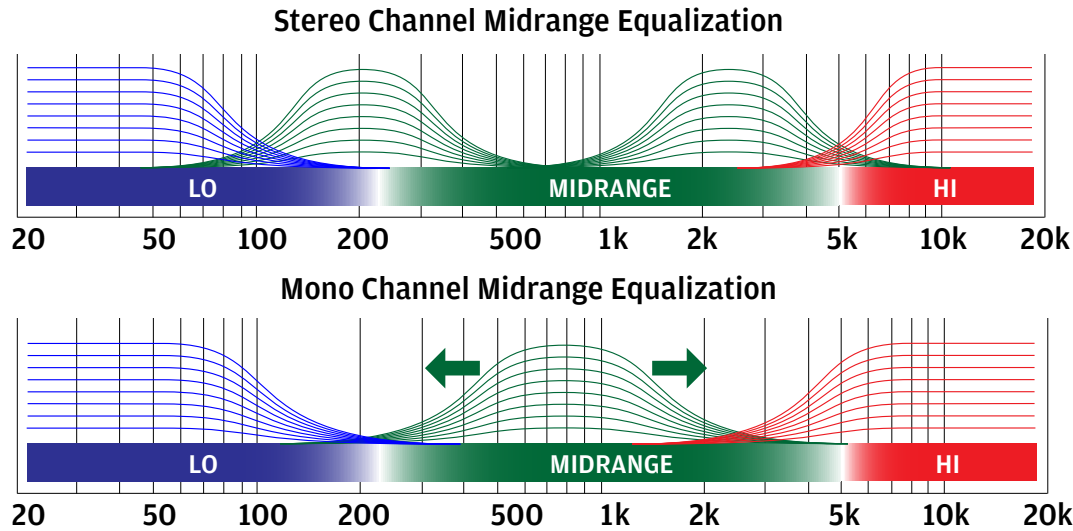
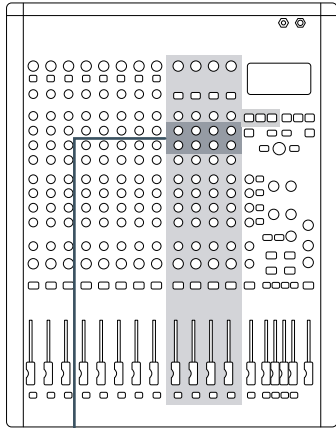

MID EQ (stereo channels)

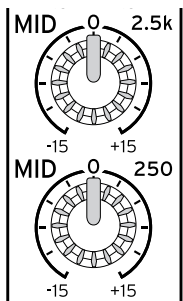

Stereo channel **MID** equalization consists of two controls with fixed band centers: 2.5kHz high Mid and 250 Hz low Mid.

That makes it different than mono channel **MID** EQ.

Whereas mono MID is one

band that can be "slid" around, stereo EQ is just two separate fixed bands, one at the high and one at the low end of the mid-range band.

Further reading about mixing.

<https://www.liveabout.com/the-basics-of-live-sound-1817739>

<https://www.behindthemixer.com/eighteen-live-audio-mixing-tips-tricks/>

<https://ledgernote.com/columns/mixing-mastering/audio-mixing-for-dummies/>

A few more tips on equalization.

- Almost everything can be improved with equalization. At least TRY various settings.
- Equalize with your ears. Don't stare at the EQ knob: close your eyes and *listen*.
- Focus on the overall mix. You're far better off EQ-ing your channels so that every instrument has its own place in the mix, rather than trying to make each instrument sound good in isolation.
- Cut first; boost second.
- In a live setting, very few people will be hearing both left and right speakers equally so it's best not to pan things dead left or right.

Analog Controls

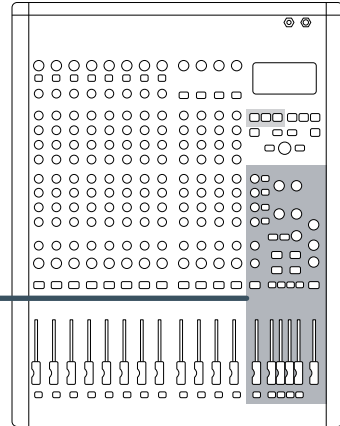
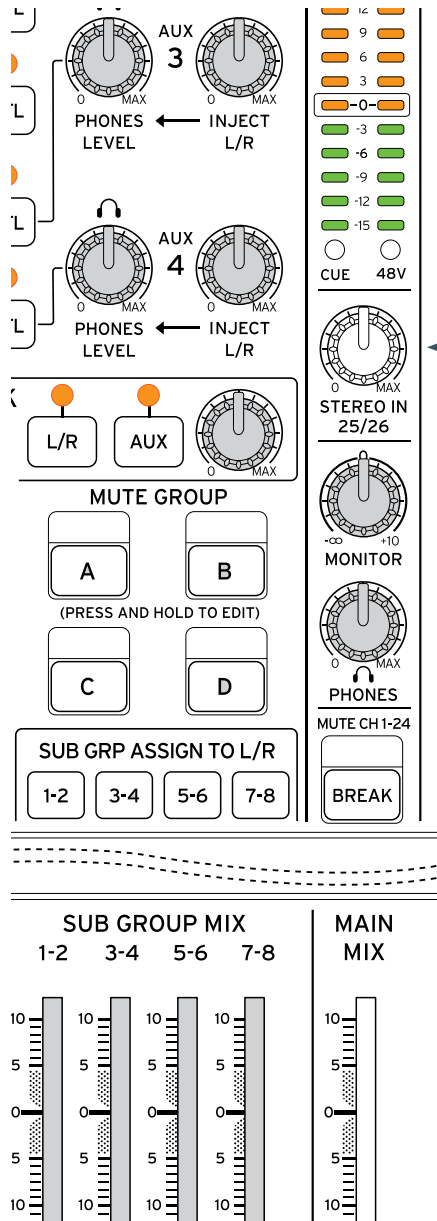

Master Control Section

This seemingly complicated checkerboard of controls is actually a dozen smaller, easier-to-understand sections, each with a unique purpose.

Some you will hardly ever use. Some play important and regular parts in key functions such as Mute Groups and Sub Groups.

AUX MASTER

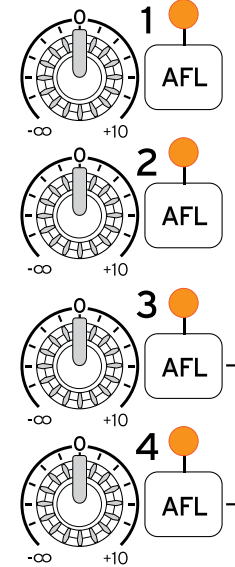

Aux Master.

As we noted earlier, the AUX buses are like four separate additional mixers.

The AUX sends on each channel strip determine how much of that channel

goes into an AUX bus.

The AUX MASTER controls determine the levels that are output to the AUX OUT jacks on the mixer back.

Aux Master AFL buttons and indicator.

Enables (—) or disables (■) the AFL function.

When this is enabled, the signals that have been adjusted by

the AUX MASTER (1–4) knobs can be monitored via MONITOR or PHONES.

When AFL is enabled, the orange LED lights up.

MUSICIAN'S PHONES

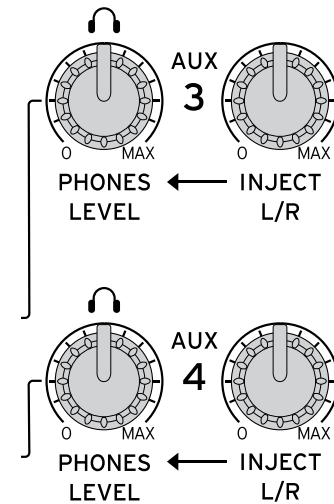

Musician's Phones.

This is a Greg Mackie innovation that takes the complication out of creating the monitor or stereo in-ear mixes that your performers want.

MUSICIAN'S PHONES

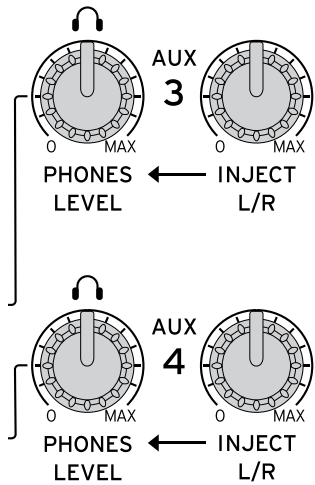

A traditional Monitor Mix.

You choose channels the performer wants to hear (usually lots of their own instrument or voice) and route those signals to an **AUX** bus. Then through of the **AUX OUT** jacks on the mixer back, and on to their floor wedge or in-ears.

That's the way it's always been done.

A better way.

But what happens if the performer wants more of the main mix in their monitor mix? That used to require tweaking every channel's **AUX** send.

- 1 Plug the musician's phones into AUX 3 or AUX 4's 1/4" output.
- 2 Turn up the **PHONES LEVEL** and into the **MUSICIAN'S PHONES** output.
- 3 Create a mono mix for that musician using channel aux sends.

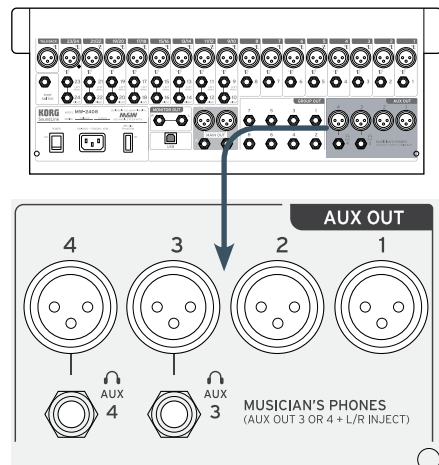

- 4 Inject a little bit of L/R signal to create L/R ambience using the **INJECT L/R** controls.

INJECT L/R knobs adjust the level at which the **MAIN L/R** bus signal is mixed into the **AUX** 3 & 4 output and into the **MUSICIAN'S PHONES** output.

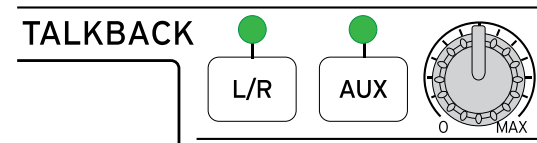

Remember that **AUX 3** and **AUX 4** are separate so you can create a "stereo" mixer.

Talkback.

This knob adjusts the volume and selects the destination of the microphone plugged into the **TALKBACK** jack on the back of the SoundLink.

You can send Talkback to all of your **AUXs** at once (for yelling at the band)... or the **MAIN L/R** for announcements to

your audience.

Pressing the L/R button sends the **TALKBACK** audio to the **MAIN OUT** output jacks. The **TALKBACK** volume is not affected by the **MAIN MIX** fader. When this is enabled, the indicator blinks.

Pressing **AUX** Sends the **TALKBACK** audio to the **AUX OUT 1-4** output jacks.

The **TALKBACK** volume is not affected by the **AUX MASTER** knob. When this is enabled, the indicator blinks.

Analog Controls

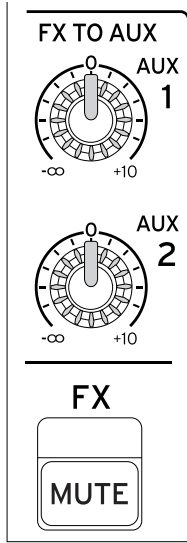

FX Master Section.

Adjusts the effect volume and muting of digital effects.

FX TO AUX (1/2) knobs adjust the volume of the effect sent to the **AUX 1/2** buses.

FX MUTE button and indicator enables/disables the **mute** function.

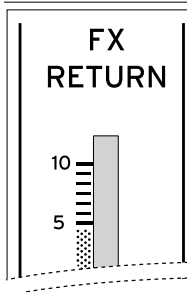

FX RETURN fader adjusts the volume of the effect sent to the **MAIN L/R** bus.

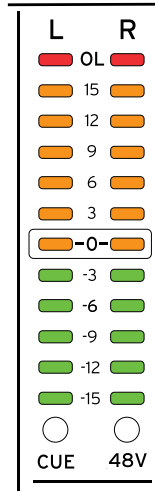
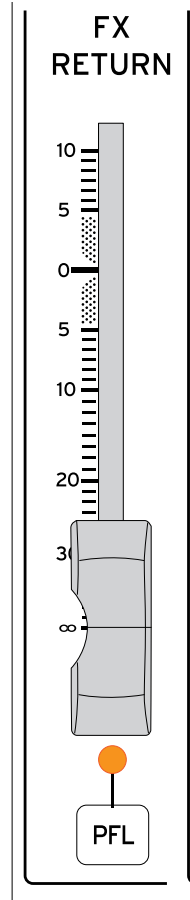

Meter section.

Level meter indicates the signal level of the monitor bus. Be careful that L/R output only momentarily goes into the orange indicators. The average signal should bounce over and under "0" db.

The **ANALYZER** screen (page 58) analyzes the same signal as shown in the level meter, and indicates the level of each frequency region.

CUE indicator indicates the signal source of the monitor bus that is shown in the level meter.

Lit: The signal of the channel or bus for which **PFL** or **AFL** is enabled

Unlit: The signal of the **MAIN MIX** bus

48V indicator lights when the **MIC** phantom power supply is on.

STEREO IN knob

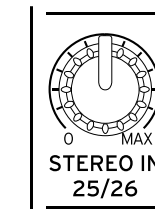

Adjusts the volume of the front panel **STEREO IN** jack.

The signal adjusted by this knob

is sent directly to the **MAIN OUT** output jacks. It is not muted by **BREAK**, etc., since that is when it's often used for music between sets or before a service.

MONITOR section

Adjusts the output level of each monitor source.

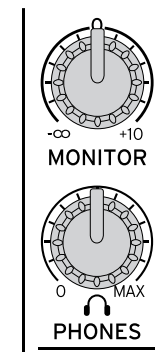

M The monitor output will output either the **MAIN L/R** bus or the monitor bus. The signal source is indicated by the **CUE** indicator.



If you connect a foot switch (sold separately), you can control **FX MUTE** remotely. If mute is enabled using a foot switch, the indicator blinks.

Analog Controls

BREAK button/indicator

MUTE CH 1-24
BREAK
MUTE for all input channels (Channel 1–24 on the MW-2408; Channel 1–16 on the MW-1608) in a single action.

Press the button again to return to the previous state.

When this is enabled, the indicator blinks.



The following inputs and buses are not muted by the BREAK function.

- STEREO IN input
- TALKBACK input
- PFL bus of each channel

Group Master Section.

Here is where you blend your Sub Group mixes into the Main L/R mix or determine their level if you're routing them out of the rear panel **GROUP OUT** jacks.

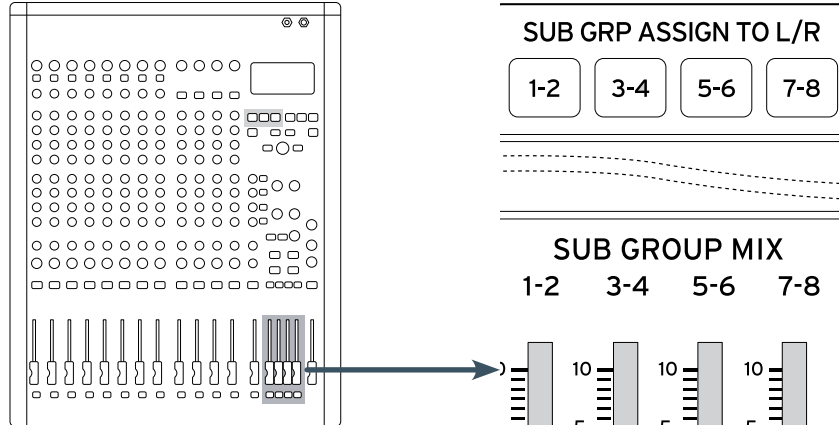

SUB GROUP ASSIGN TO L/R switches

These switches send the signal of each group to the **MAIN L/R** bus.

SUB GROUP MASTER faders

Adjusts the output level sent to the Main L/R (if assigned) and to the Sub Master Outputs.

PFL switches/indicators.

These switches let you audition each group's signal in the monitor.

When they are enabled, the signal that has been adjusted by each **SUB GROUP MIX** fader is sent

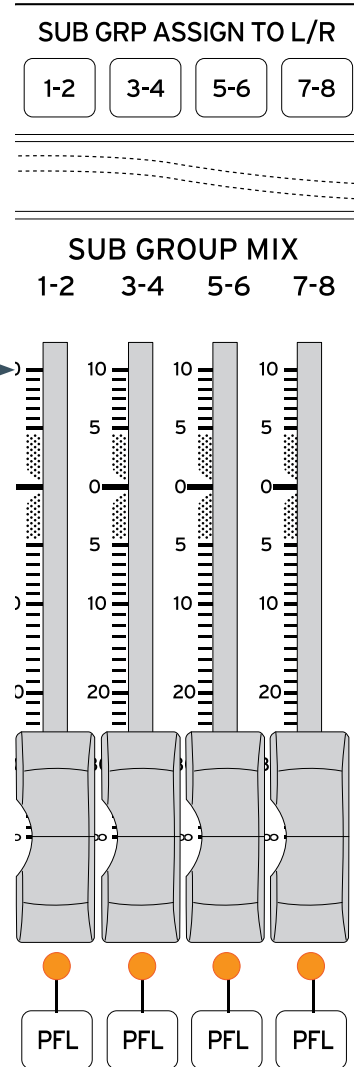

to the **PHONES** jack and to the **MONITOR OUT** output jacks. If this is enabled, the indicator is lit.

MAIN MIX (L/R) fader.

Adjusts the level of the **MAIN MIX**.

The signal adjusted by the **MAIN MIX** fader is also sent to the USB port output.

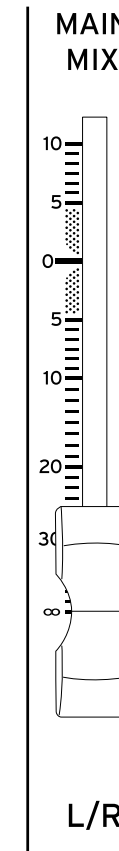

MUTE GROUPS

Channel mutes are found on most every analog and digital mixer. Press the Mute button and the channel becomes silent. Easy peasey.

But SoundLink mixers make it *easier*.

Selecting channels for a Mute Group.

On SoundLink mixers, the **MUTE** button glows red to show that the channel is muted.

Here's an example application where you're mixing a whole band most of the time, but for a couple of slow songs, there's just a vocalist, an acoustic guitar through a direct box and a snare drum.

The last thing you want to do is reduce each fader volume to ∞ (0,) because you lose your carefully-set levels.

Instead, you press **NINE** mute buttons. Nine mute buttons turn red. Nine channels are removed from the mix.

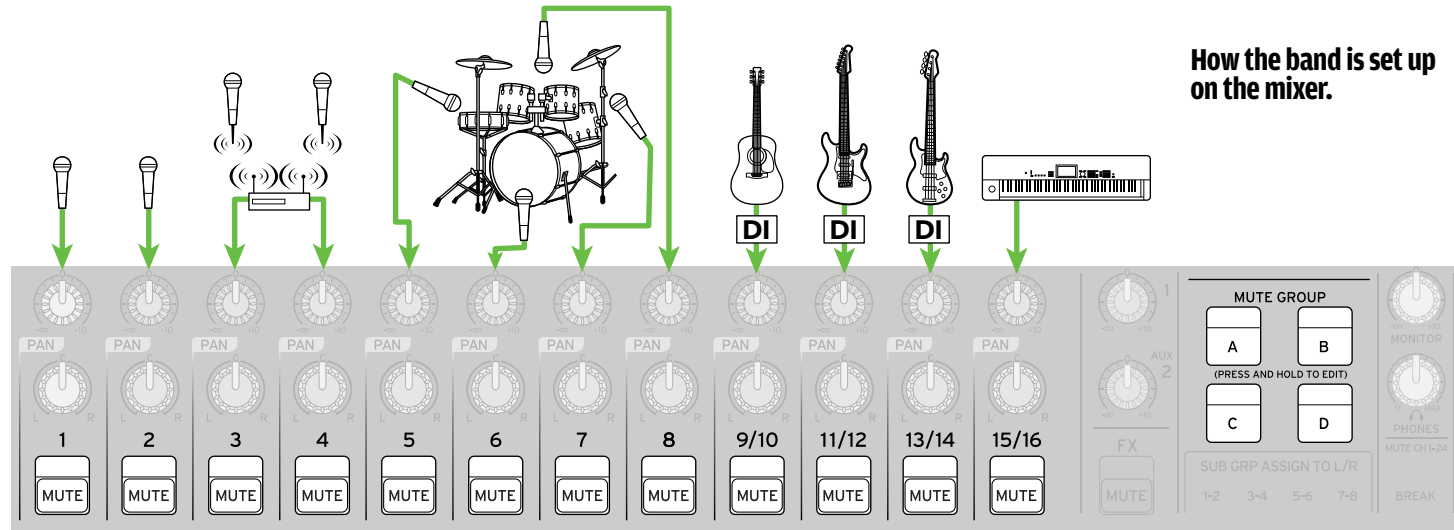

How the band is set up on the mixer.

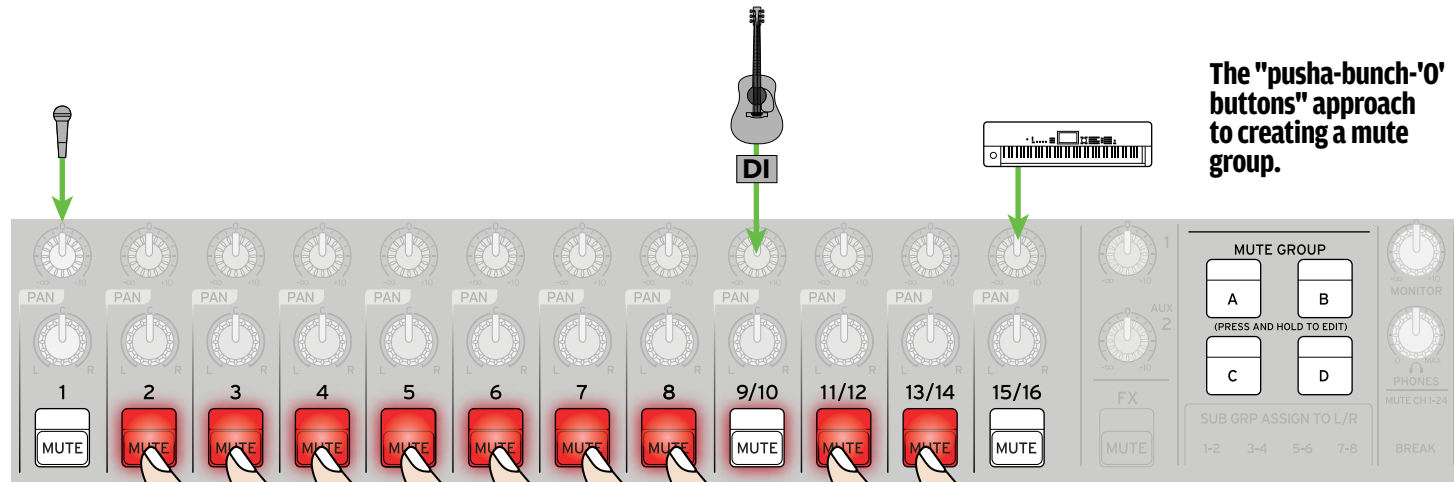

The "pusha-bunch-'O' buttons" approach to creating a mute group.

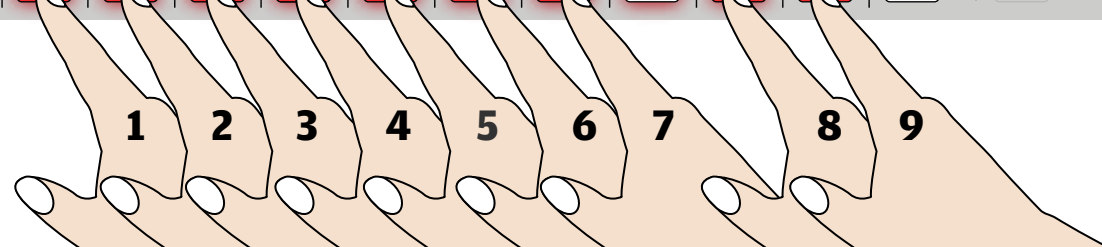

The vocalist, acoustic guitar and brushes on the snare makes for a pleasant, slower interlude in the band's otherwise intense set. It ends.

You quickly press **NINE MUTE** buttons again, **UN**-muting the channels so you're ready for the whole band to play the next song

Eighteen button pushes in rapid succession.

You could get calluses pushing all those buttons (or more likely, delay the next song while you punch lots of **MUTE** buttons)!

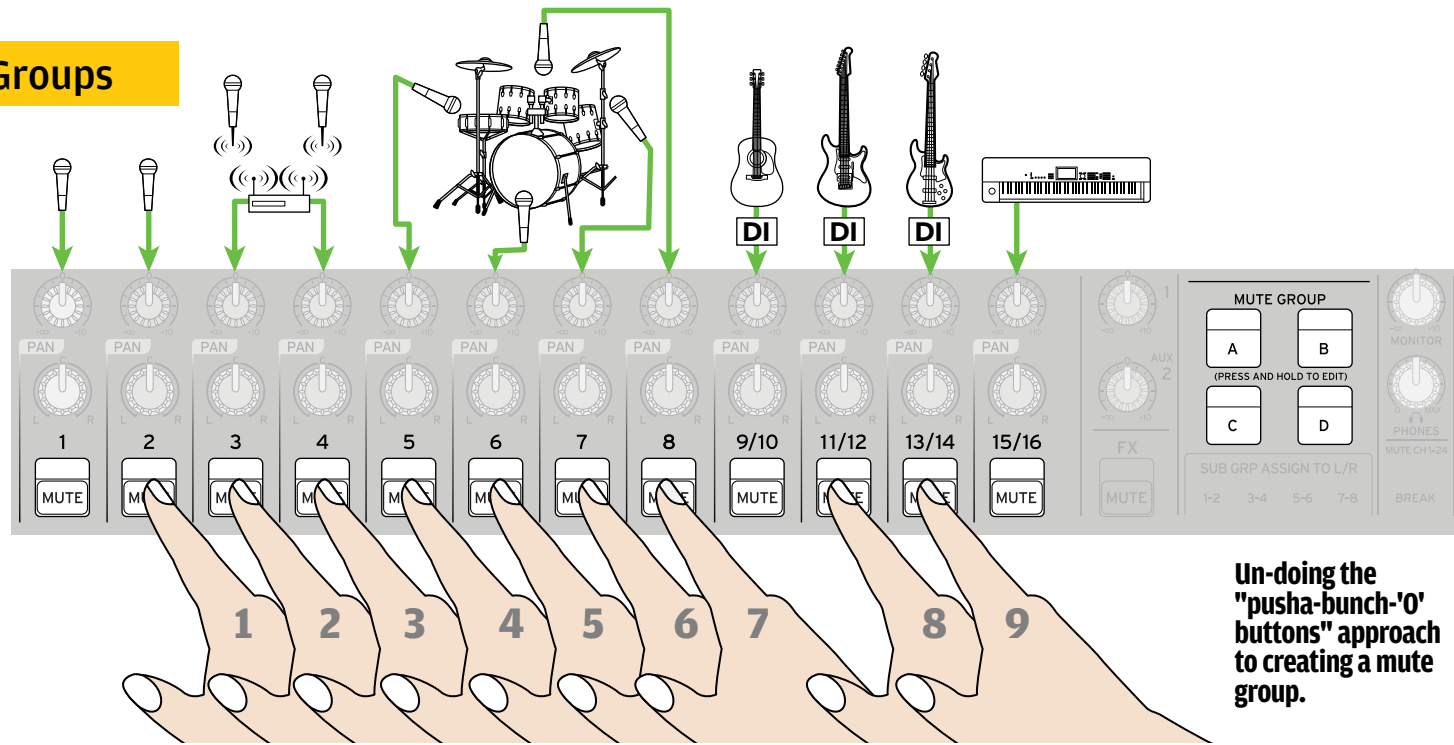

MUTE GROUPS TO THE RESCUE.

- 1 Press and momentarily hold down **MUTE GROUP** button A. It will blink orange, which means it's ready to be "programmed".
- 2 Now press the nine **MUTE** buttons.

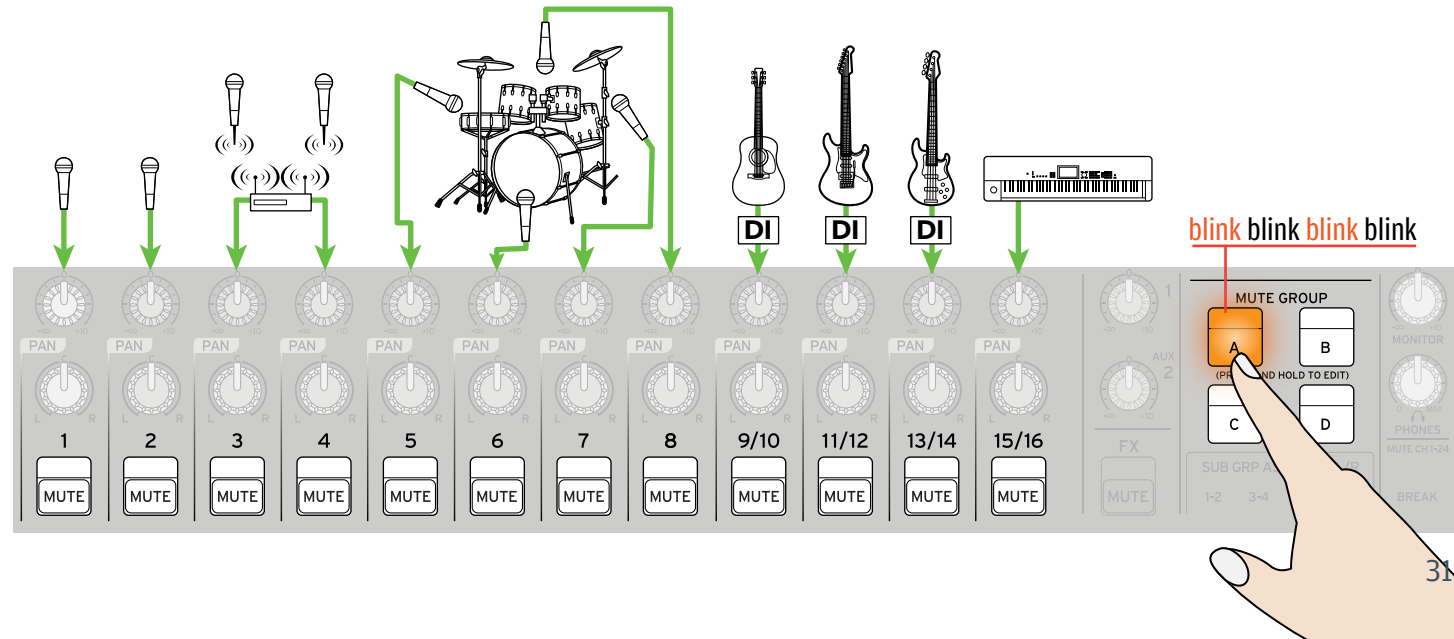

Each muted channel button/indicator will turn orange.

You're "telling" **Mute Group A** which channels to include.

- 3 Press the blinking **MUTE GROUP A** button. You have just created a genuine Certified Mute Group.

Mute Group A is now stored for the duration of the session. Press **MUTE GROUP A** and nine channels are instantly muted.

You've pressed one button, instead of nine buttons.

Mute Groups have a lot of uses because in many mixing situations, some of the channels are not being used. And when a channel isn't being used, it should be off.

For example... muting parts of the band when they're not playing. Or selecting just a few channels like in our mic/guitar/

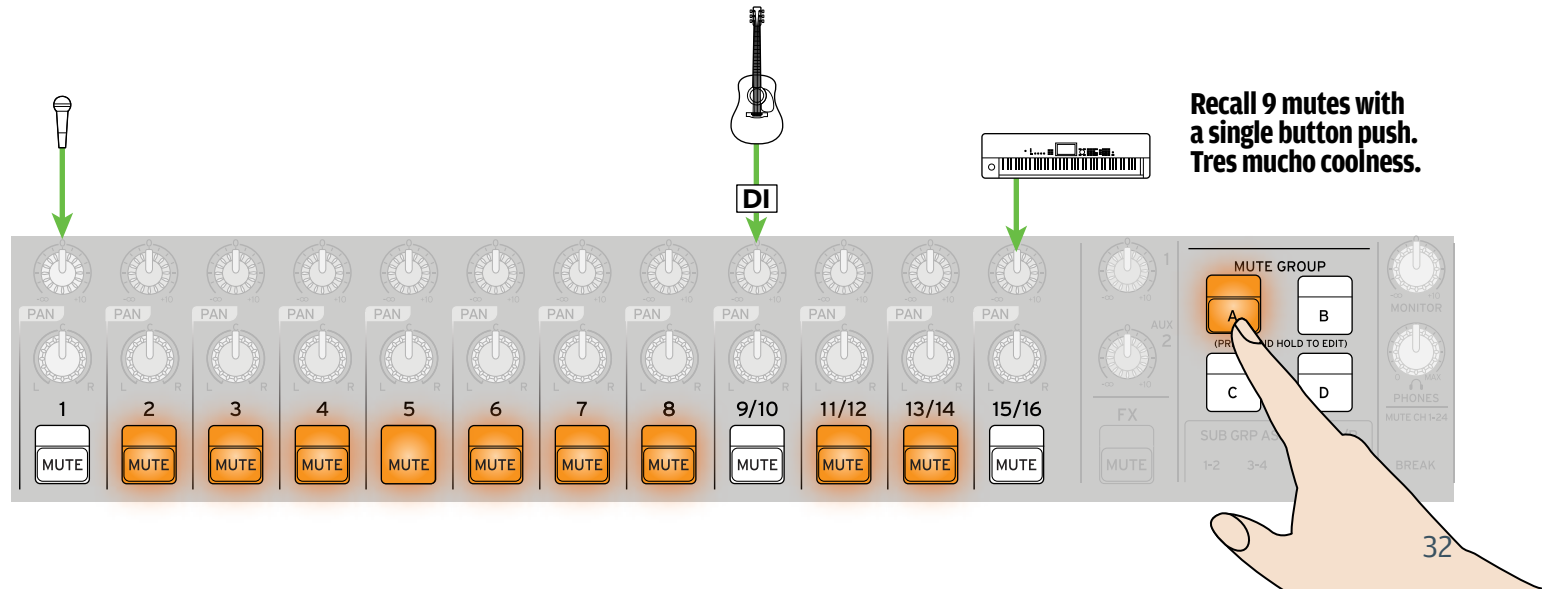
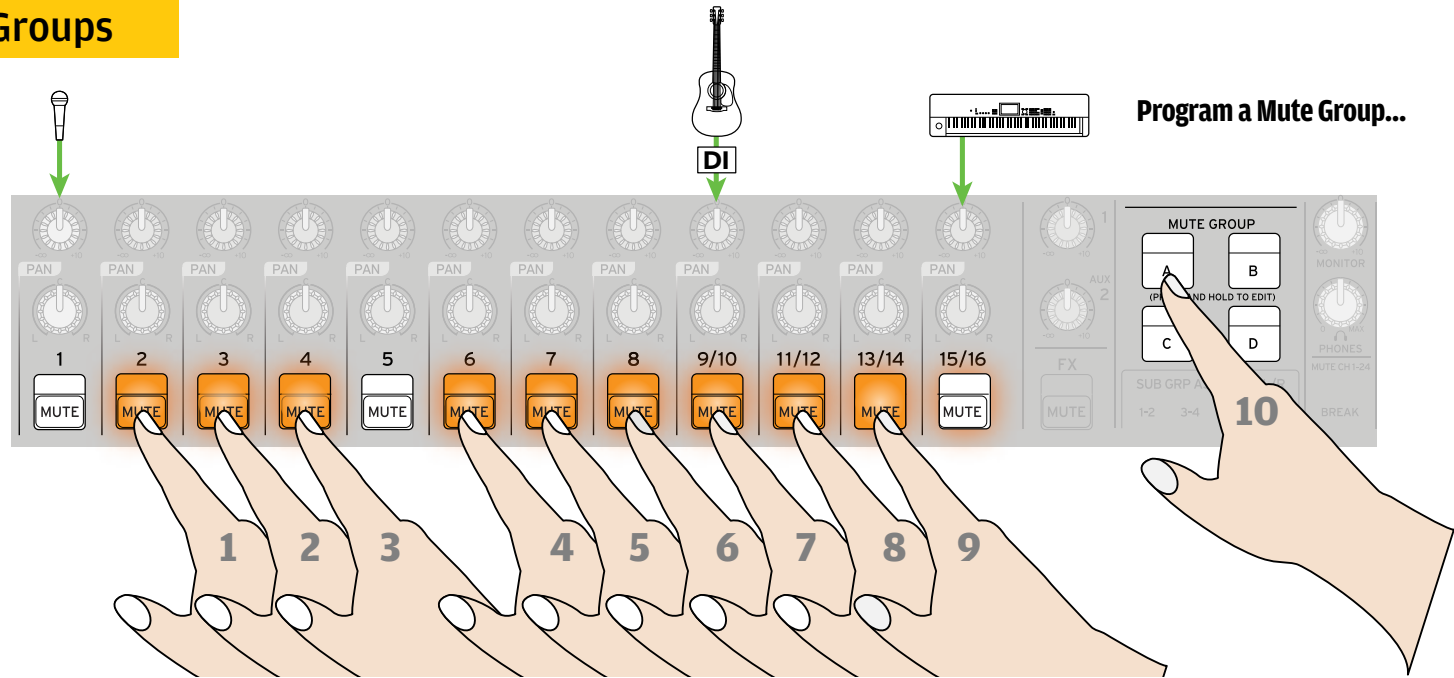

snare example.

In a business presentation, you might have one person giving a speech, and then three microphones being passed around in the audience for questions.

And in a church service, mute groups are invaluable. Set up one for Pastor Sermon, one for Praise Band, another for Choir and Soloist, and one for Pastor+Choir+Praise Band for hymns.

Pushing just one **MUTE GROUP** button is far easier for a volunteer than sorting out which channels to un-mute.

Since you can store up to 10 unique Mute Groups as part of Global Settings, you can have "Mute Groups for any occasion".

"Hard muting".

This is a name for when you just directly mute a channel. The Mute indicator for that channel turns red.

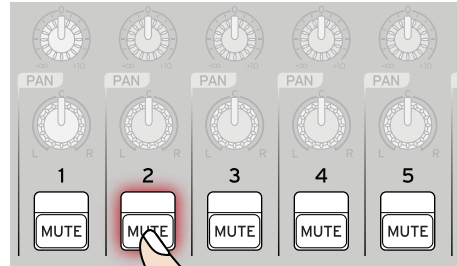

Hard muting:
pick a channel;
press the MUTE button.

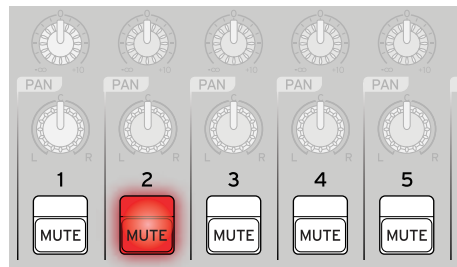

Bask in the warm red glow.

Creating a Mute Group.

- 1 Press and hold a **MUTE GROUP** button (**A** through **D**) until it starts blinking.
- 2 Mute the channels you want in the Mute Group. Each channel indicator will blink orange after you press it.
- 3 Press the designated **MUTE GROUP** button. It will turn off.
- 4 The Mute Group is now programmed. At any time, just press the **MUTE GROUP** button and all of those channels will be muted – with orange indicator lights.

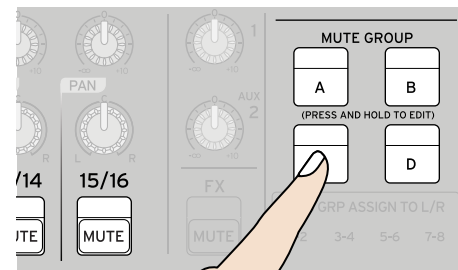

The Mute Group is now ready.

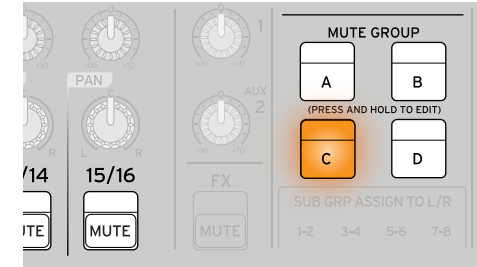

Pick the channels you want to have in the Mute Group.

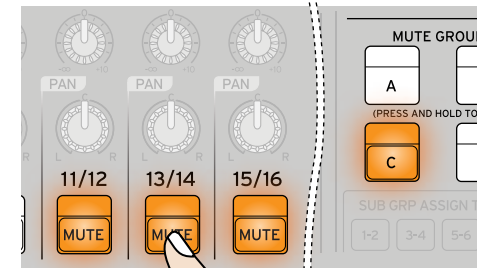

Adding to or subtracting channels from a Mute Group.

- 1 Press and hold the pre-programmed **MUTE GROUP** button (**C** in our example below) until it starts blinking.

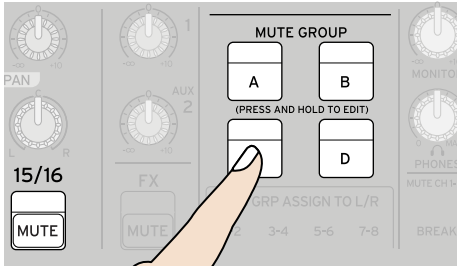

Pick the Mute Group that you want to edit.

- 2 The channels in the Mute Group will all blink orange.

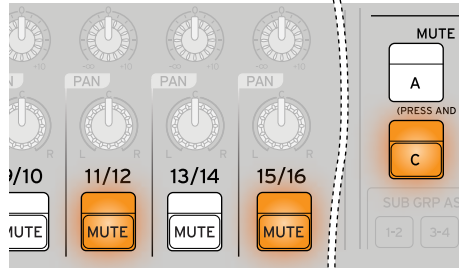

- 3 Either press a blinking channel to turn it off, or press a new channel **MUTE** button to add it to the Mute Group.

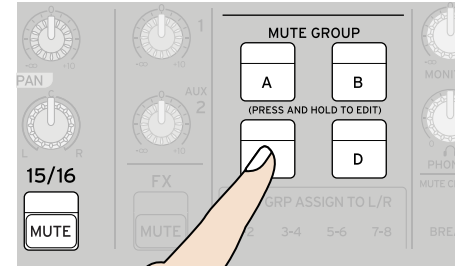
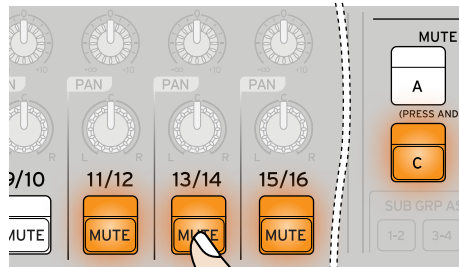

- 4 Press the designated blinking **MUTE GROUP** button. It will turn off. The Mute Group is now edited.



You can turn on more than one Mute Group at the same time, in effect temporarily adding to the Group.



Press and HOLD is only needed to program or modify (re-program) a Mute Group

Combining Hard Mutes and Mute Groups.

In our example below, we have “hard”muted some channels. Their indicators glow red.

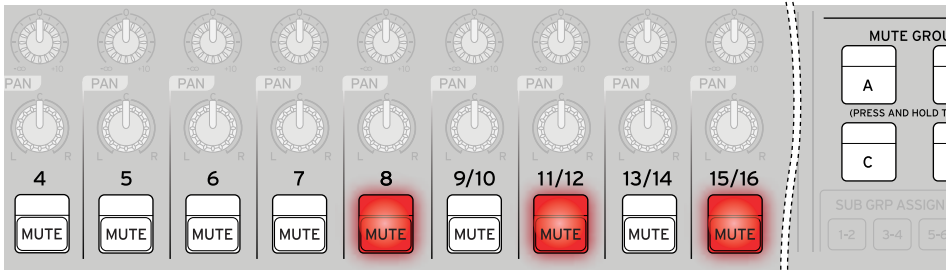

Now we’re simply going to create a Mute Group:

- 1 Press and hold a **MUTE GROUP** button until it starts blinking orange. *The red Hard Muted indicators will turn off.*

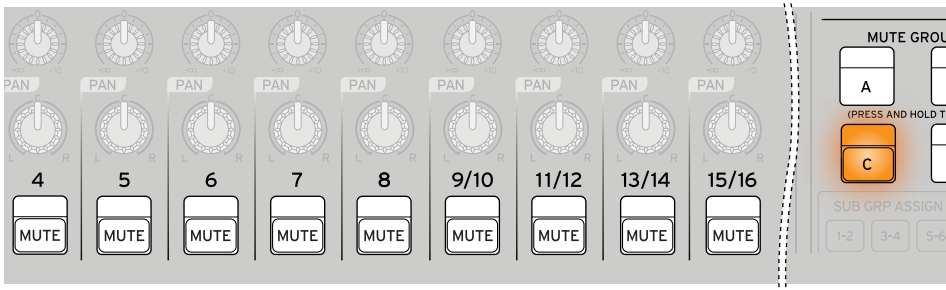

- 2 Select channels for your Mute Group. They will blink orange.

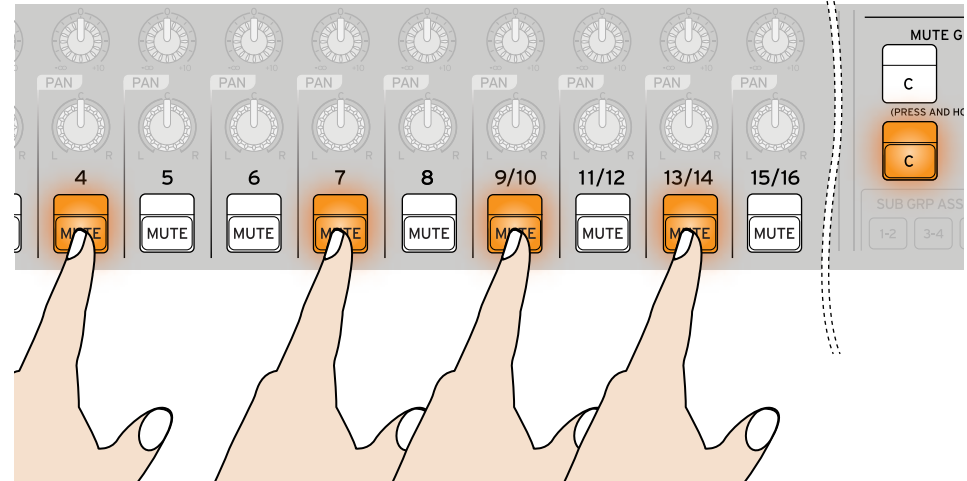

- 3 Press the **MUTE GROUP** button.

The red Hard Mute indicators come back on. The Mute Group has been created.

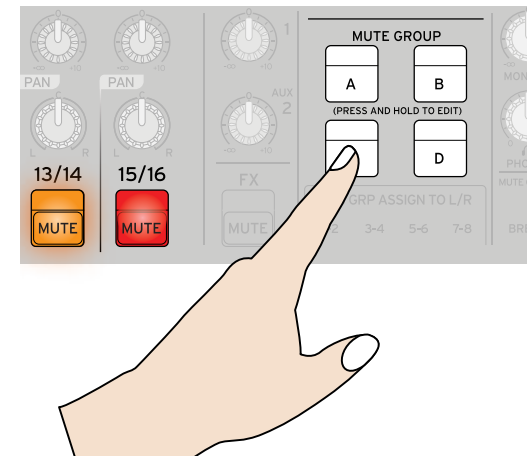

Analog Controls

Now the Mute Group mutes (orange) can be added to any hard mutes (red) that you have on.

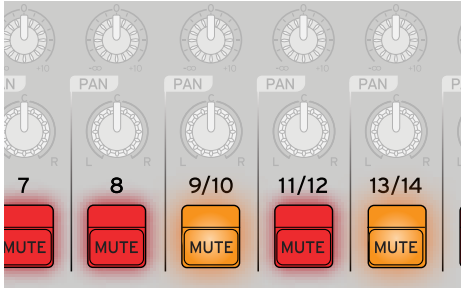

Saving and Recalling Mute Groups.

Mute Groups are really a part of hybrid SoundLink’s digital section. You can store and recall ten Mute Groups as part of Global Settings.

For instructions on saving and recalling Mute Groups via Global Settings, click to [page 54](#).

Digital Controls

SoundLink mixer’s digital section packs a lot into a modest space. It has more direct, hands-on buttons and controls than most mixers so that you can quickly assign and adjust more things.

For example, just below the LCD screen are 9 buttons that let you select various options from the screen instead of having to

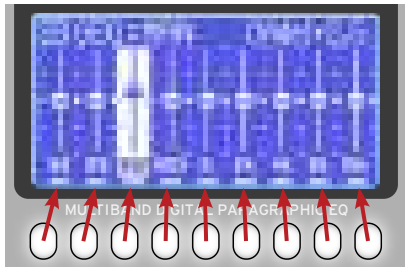

Each equalizer frequency band has its own SELECT button for fast access.

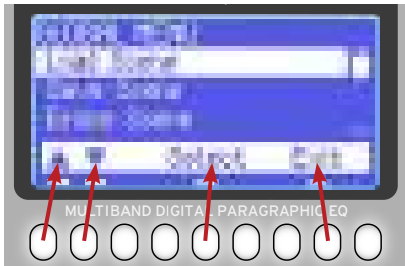

The buttons can also select and scroll during various procedures.



drill through more menus.

An encoder knob is rotated to set values, or pushed down to enter a command.

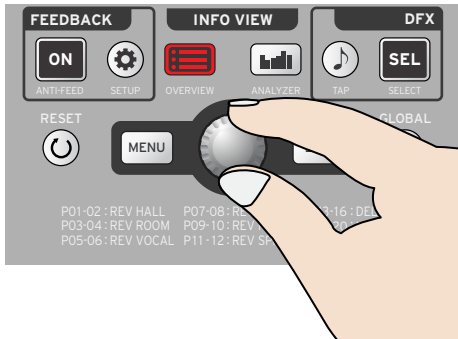

GETTING STARTED

When you turn on your SoundLink mixer you get a KORGE logo, splash screen and then this “home” screen:

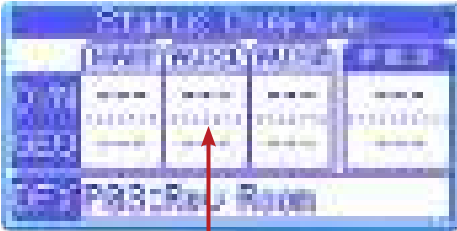

The three columns show where you have assigned *DYNAMics*, *Graphic EQ*ualizer and *Digital Effects*.

As you begin to add signal processing, the *Status Overview* screen will look something like



this.

SoundLink's has a lot of powerful digital features.

In order to help you navigate, we have created a sub-Table of Contents showing on which page various functions are explained. Click on one of these red rectangle links.



Click to navigate to that Digital Section.

Effects

Dynamics

Equalization

Feedback

Global Scenes

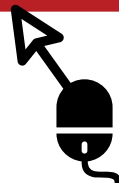

Click to navigate to that Digital Section.

Digital Effects (DFX).

DFX provides 16 types of effects and tone generator function that can output reference tones useful for PA work.

You can edit an effect and save it as a user type (maximum 30).

Selecting the DFX type

- 1 Press the DFX section's **SELECT** button. This screen appears.

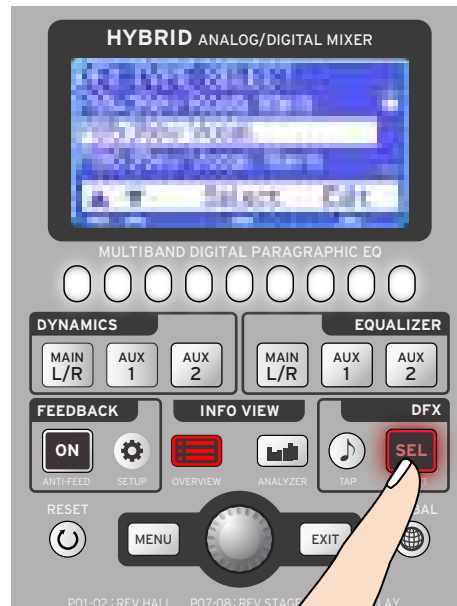

Type	Details	Parameter / effect
P01: Rev Hall P02: Rev Hall Warm	Provides the reverberation of a hall. "Rev Hall Warm" provides a warm tone.	Time (Time that the reverberation continues) HiDamp (High frequency attenuation of the reverberant sound over time)
P03: Rev Room P04: Rev Room Warm	Provides the reverberation of a small room. "Rev Room Warm" provides a warm tone.	
P05: Rev Vocal P06: Rev Vocal Warm	Provides reverberation suitable for vocals. "Rev Vocal Warm" provides a warm tone.	
P07: Rev Stage P08: Rev Stage Warm	Provides the reverberation of a mid-sized stage. "Rev Stage Warm" provides a warm tone.	
P09: Rev Plate P10: Rev Plate Warm	Provides the reverberation of a plate reverb unit. "Rev Plate Warm" provides a warm tone.	Time (Time that the reverberation continues) Sway (Amount of modulation for the spring)s
P11: Rev Spring P12: Rev Spring Warm	Provides the distinctive reverberation of a spring reverb unit of the type often built into a guitar amp. "Rev Spring Warm" provides a warm tone.	
P13: Delay Analog	Adds a delayed sound. This models a warm-toned analog delay.	Time (Delay time) Feedback (Amount of repeated delay sounds)
P14: Tape Echo	Adds a delayed sound. This models a tape echo that balances warmth and clarity.	
P15: Delay Standard	Adds a delayed sound.	
P16: Delay SDD3000	Adds a delayed sound. This produces a clear delay sound modeled on the Korg SDD3000 digital delay.	



Use the dial or the function buttons to select a type.

Dial: Turn the dial to move the cursor to the desired effect type, and then press the dial to confirm.

Function buttons: Use "▲"/"▼" to change the effect type. When you press a button, the effect changes immediately, so you can listen to the effects as you switch through them.

Applying a Digital Effect

- 1 Make sure that the FX MUTE indicator is off (dark).
- 2 Raise the FX RETURN fader to the "0" position.
- 3 Use each channel's FX SEND knob to adjust the level sent to FX.
- 4 Use the FX RETURN fader to adjust the overall level of the effect sent to the Main L/R or Auxes.

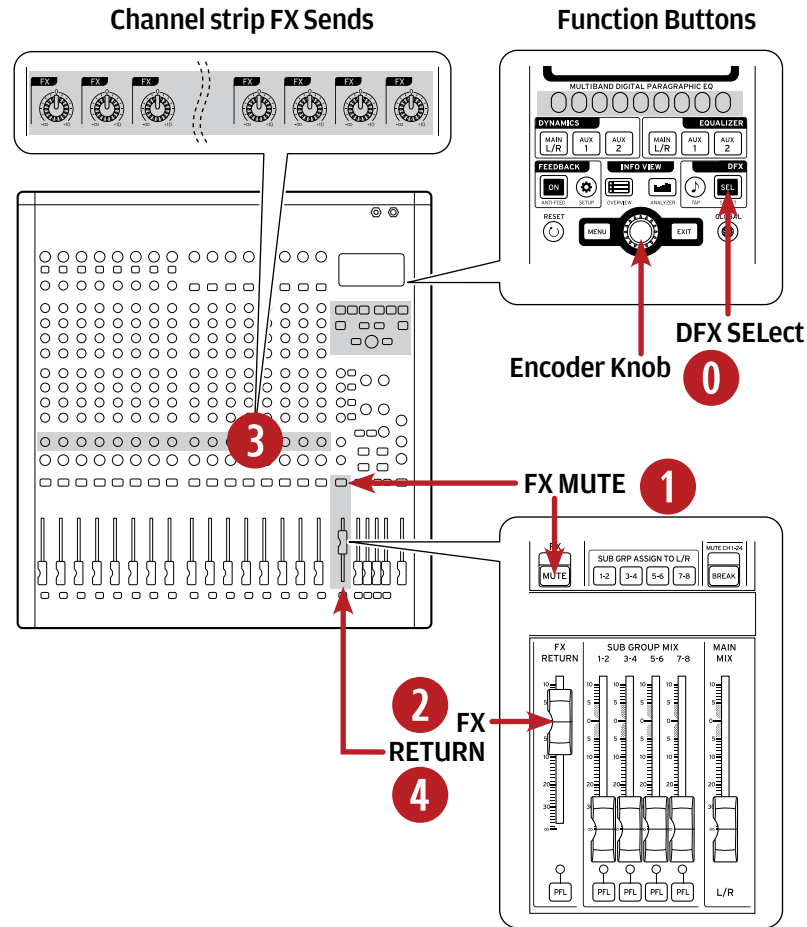

Editing an effect

You can edit the effect parameters to adjust the effect. The result of editing the parameters will differ depending on the effect type. For details, refer to the chart on the previous page.



- 1 Select an effect type.



- 2 Press the function button indicated as "Edit."
- 3 Use the function buttons to select a parameter.
- 4 Turn the encoder knob to make adjustments.
- 5 To return to the previous screen, press the EXIT button or the function button indicated as "TYPE."



If you press the **RESET** button, the currently-edited parameter returns to its default value.



If you long-press the **RESET** button, the currently-edited effect is initialized.



Depending on the settings, the sound might be distorted or produce oscillation.

Using the TAP button to set the delay time.

For delay effects, you can set the delay time by pressing the **TAP** button at the desired interval. You can use the **TAP** button for the following effects.

- - Delay Analog
- - Tape Echo
- - Delay Standard
- - Delay SDD3000

- 1 Select a delay effect type.
- 2 The **TAP** button blinks at intervals of the time parameter setting.
- 3 Repeatedly press the **TAP** button at the interval that you want to specify. The time is specified according to the average value of the intervals between button presses.

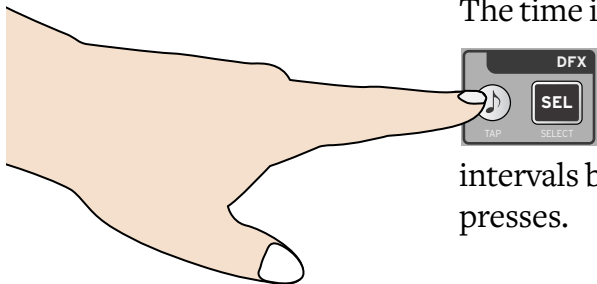

Saving a Digital Effects setting.

You can edit an effect and save it as a user type (maximum 30), and then recall it at any time.



- 1 After you have made adjustment to an effect, press the **MENU** button, which will light up green.



- 2 On-screen you will see *Save User Type* and *Erase User Type* options.

Use the button under *Select* to pick *Save as User Type*.



- 3 Scroll up or down with ▼ and ▲, or the encoder knob, pick an *Empty* location and press *Select*.



The screen will query you as to whether you want to save the setting. Hit **Save** to finish.

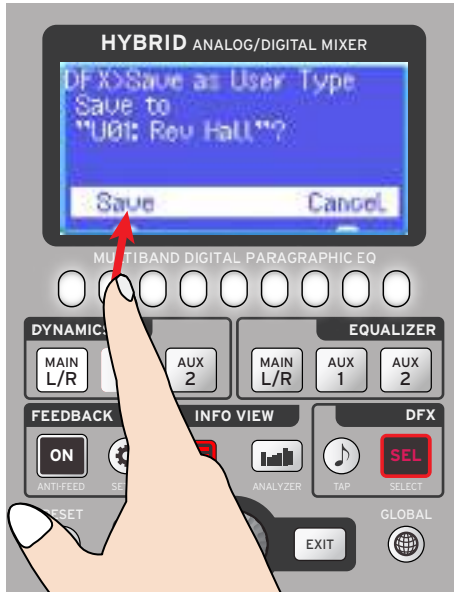

Note that you can also save a DFX setting in the **GLOBAL** menu's "Save Scene" and "Memorize Mode" (page 54.)

Recalling a DFX preset.

Here's how to recall DFX settings that you saved.

- 1 In the **DFX** section, press the **DFX SELECT** button.

A list of thirty user spaces, numbered U01 to U30, will appear.

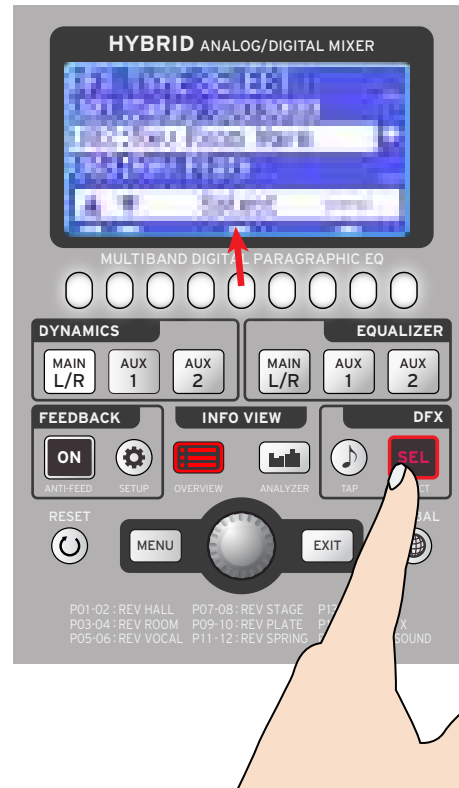

- 2 Scroll through them with the arrow buttons or encoder knob and pick an existing preset.
- 3 Press straight down on the encoder knob or the button under "Select" to choose a preset.

The recalled Digital Effects settings are applied.



To return to the previous screen without recalling DFX settings, press the **EXIT** button or the function button indicated as "Exit."

Gee, they don't *sound* like effects!

There are four more "effects" at the bottom of the scrolling menu.

They are test tones that are designed to be used with the SoundLink Spectrum Analyzer.

- **1Khz Sine Wave**
- **Slow Sweep (through the whole frequency spectrum)**
- **Sweep Fast (through the whole frequency spectrum)**
- **White or Pink Noise**

How they are best used is beyond the scope of this manual.

To blatantly borrow from Wikipedia, "A spectrum analyzer measures the magnitude of an input signal versus frequency within the full frequency range of the instrument. By analyzing the spectra of electrical signals, dominant frequency, power, distortion, harmonics, bandwidth, and other spectral components of a signal can be observed."

SoundLink Signal Processing*

Here are your options:

DYNAMICS

● Hard Compression

- Main L/R
- AUX 1
- AUX 2

● Soft Compression

- Main L/R
- AUX 1
- AUX 2

● Noise Gate – Hard

- Main L/R
- AUX 1
- AUX 2

■ Noise Gate – Soft

- Main L/R
- AUX 1
- AUX 2

■ Limiter

- Main L/R
- AUX 1
- AUX 2

Each of these dynamics types is simultaneously available on L/R, Aux 1 and Aux 2. That's more processing power than any comparably priced mixer!

The *Limiter* is especially useful on wedge monitors or in-ear-systems fed by Aux 1 or 2. It abruptly "limits" output to protect musician's eardrums.

A *Noise Gate* allows a signal above a certain selected threshold to pass through. If the input signal falls below the threshold, the signal gets cut off and no sound is heard.

It can also eliminate footsteps during quiet services and ceremonies.

EQUALIZATION

● 9-band EQ Wide

- Main L/R
- AUX 1
- AUX 2

● 9 / 31-band EQ Narrow

- Main L/R
- AUX 1
- AUX 2

By "9 / 31-band EQ" we mean that you can single out and boost/cut nine specific bands out of 31. They can be close together or sprinkled through out the whole 63 to 16k range. This perfect for "notching out" persistent feedback.

FEEDBACK SUPPRESSOR

- Main L/R
- AUX 1
- AUX 2

There are no specific adjustments for the Feedback Suppressor. It just works – and surprisingly well at that.

You have three Feedback

Suppressors at your service, assignable to Main L/R, Aux 1 and Aux 2, and that's a good thing. As noted about the Limiter, sudden feedback in floor wedges or in-ear monitors can be very harmful to the ears. The Suppressors assignable to Aux 1 and Aux 2 can prevent problems.

*We differentiate between signal processing and effects. Effects are the highly realistic digital effects such as reverbs and echos that SoundLink is capable of. Signal processing are ways to change a sound's character.

Dynamics

Our example task is to put a Limiter on Aux 1.

- 1 Press the **DYNAMICS AUX 1** button. It will blink red.

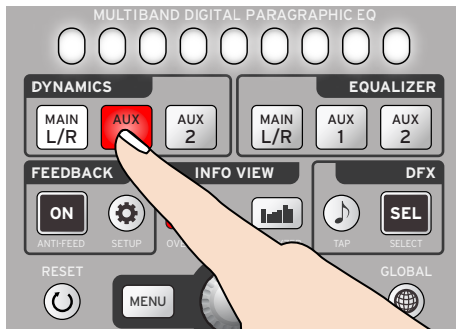

The screen will change to a dynamics screen.

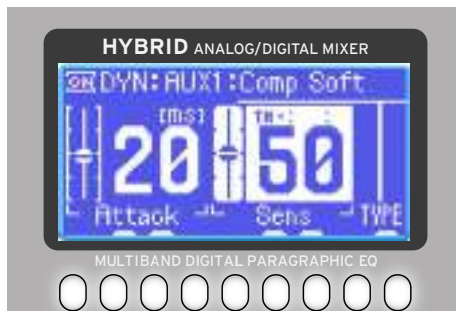

- 2 Press the white button under the word **TYPE** on the LCD screen.

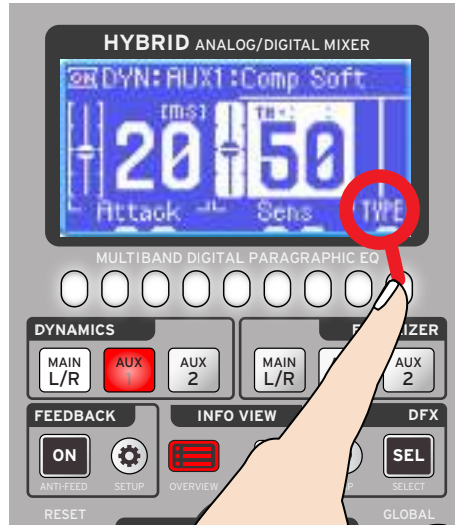

The types of dynamics will be shown in a scrolling list.

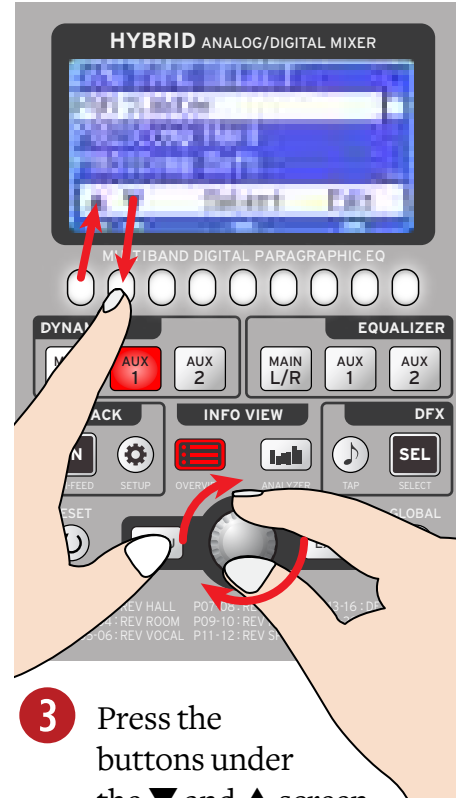

- 3 Press the buttons under the ▼ and ▲ screen triangles
OR
rotate the jog wheel to arrive at the dynamics effect you desire.

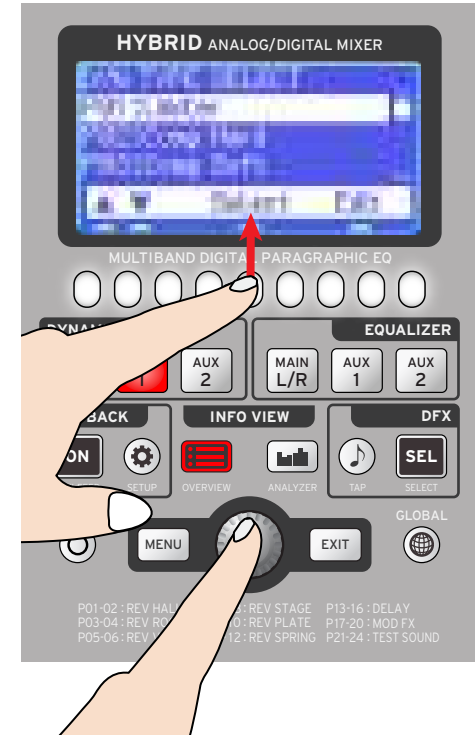

- 4 To select a dynamic effect (in our example, Limiter), press and hold the button under *Select*
OR
push down on the encoder wheel until you feel a click.

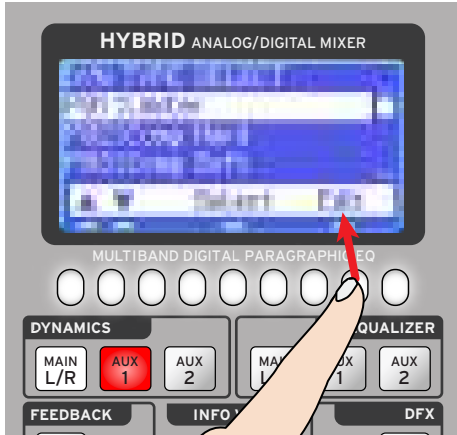

5 Push the button under *Edit*.
Now the Limiter's adjustable parameters are revealed.



A limiter is basically a very fast compressor with a very short attack and a moderately short release. *Attack* controls how fast the limiter takes to react; *Sens* (sensitivity) determines how intense a signal it reacts to.

- 5** To change a parameter, press one of the two buttons under either *Attack* or *Sens*. One of the parameters will illuminate.
- 6** Rotate the encoder wheel to set the parameter value.
- 7** Press down on the encoder wheel to enter and confirm the parameter value.



If you press the red **INFOVIEW** button, the display will return to Status Overview and you will see that **LIM**iter on Aux 1 is now active.

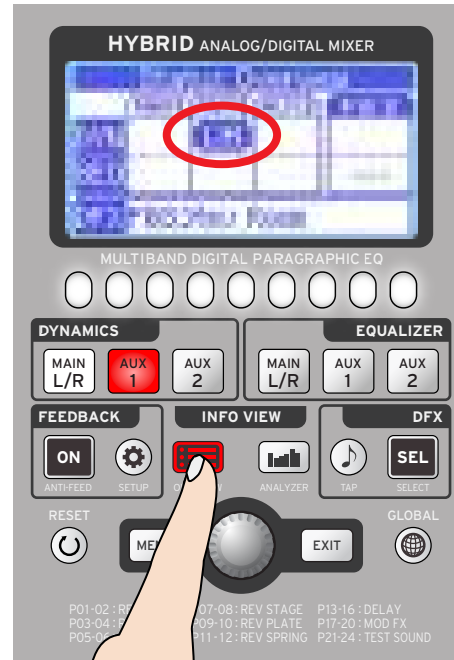

- 8** How do you cancel a dynamic processor? Press the active (designated blinking) **DYNAMICS** button. The effect with stop, the



button will change to intermittent blinking and a great big OFF will appear.

 Don't forget, you can have three different dynamic processors running at the same time

 Monitor mixes created with Aux 1 and Aux 2 can particularly benefit from compression and limiting..

Saving a Dynamics setting.

- 1 After you have made your adjustment to dynamics parameters, press the **MENU** button, which will light up green.

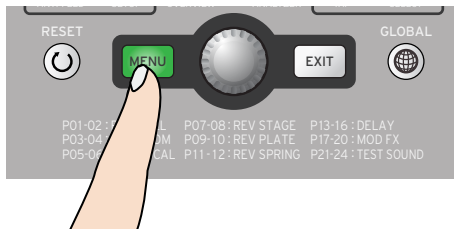

- 2 On-screen you will see *Save User Type* and *Erase User Type* options.

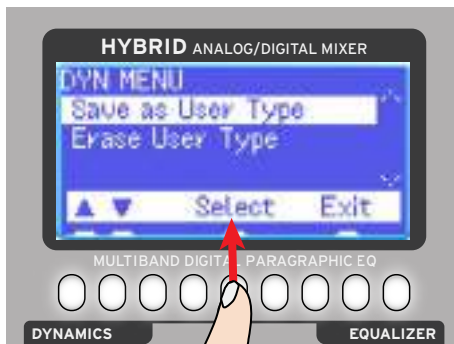

Use the button under *Select* to pick *Save as User Type*.

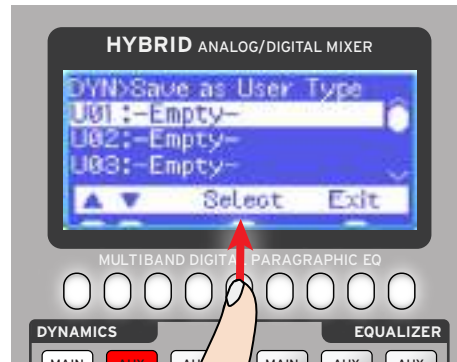

- 3 Scroll up or down with ▼ and ▲, or the encoder knob, pick an *Empty* location and press *Select*.



- 4 Press *Save* and you have now captured a Dynamics preset.

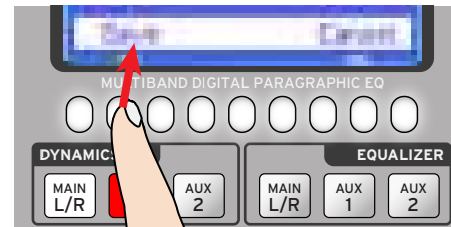

Note that you can also save a dynamics setting in the **GLOBAL** menu's "*Save Scene*" and "*Memorize Mode*."

Recalling a Dynamics preset.

To recall saved dynamics settings, select the number of the *save-destination* in Step 3 at left.

Digital Equalization

Main L/R, Aux 1 and Aux 2 can have your choice of two different types of digital equalization.

9-band Graphic – Wide. The bandwidth approximately two octaves.

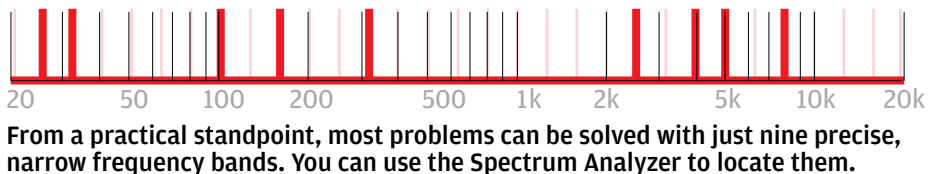
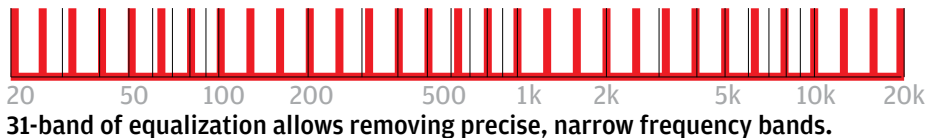
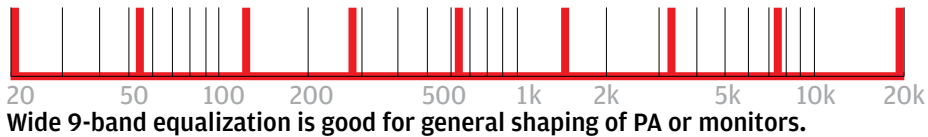

31 / 9-band Graphic – Narrow. This unique SoundLink feature lets you choose nine 1/3-octave bands.

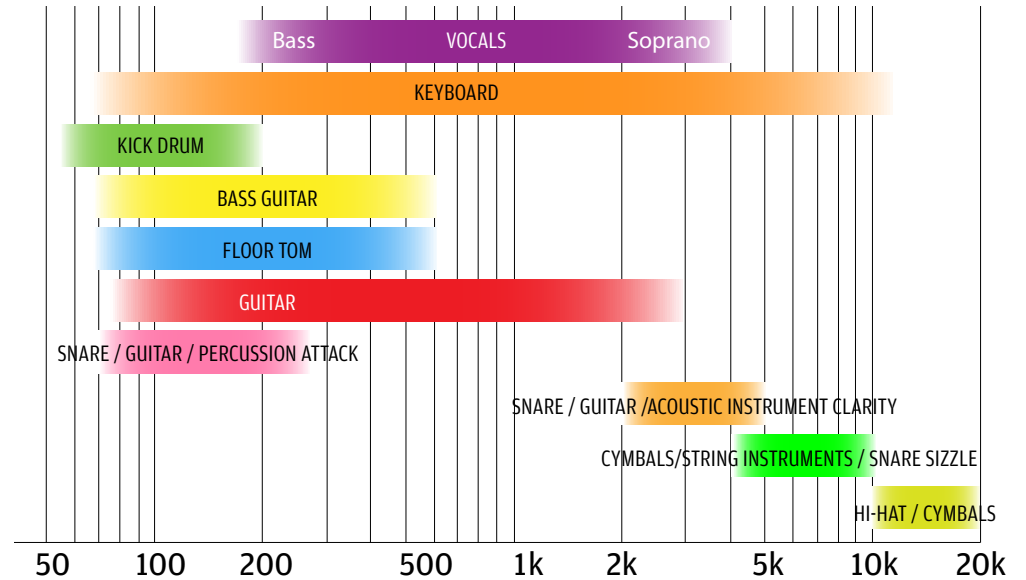
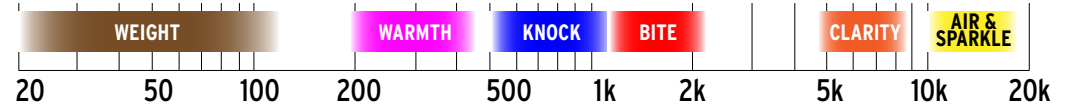

Selecting Narrow or Wide 9-band equalization.

The 9-band equalization mode has two different bandwidths (wide forvoicing and tonality and narrow for pobleem solving), which increases its usefulness in contouring monitor feeds and your main PA.



You can use the Equalization section in Narrow or Wide modes, but not both at the same time. In other words, you can not use one band of the EQ as Wide band and another as Narrow simultaneously.

If necessary, re-orient yourself by returning to the *Status Overview* Screen.



- 1 Select one of the EQ destinations: **Main L/R**, **Aux 1** or **Aux 2**.
The 9-band equalizer display will appear.



- 2 Press the **MENU** button. The display will show your options.
- 3 Choose **Select EQ Mode** by pressing the button below **Select**, or by pressing down the encoder knob.



- 4 The Wide / Narrow options appear. Use **▶** and **◀** to move between them, or turn the encoder knob.
After you have made your choice, press the button under **Select**, or push the encoder knob down.



- 5 After selecting Wide or Narrow options, the screen will revert to EQ Menu. Press **Exit** to end the operation.

Adjusting 9-band EQ (Wide Mode).

- 1 Select one of the EQ destinations: **Main L/R**, **Aux 1** or **Aux 2**.

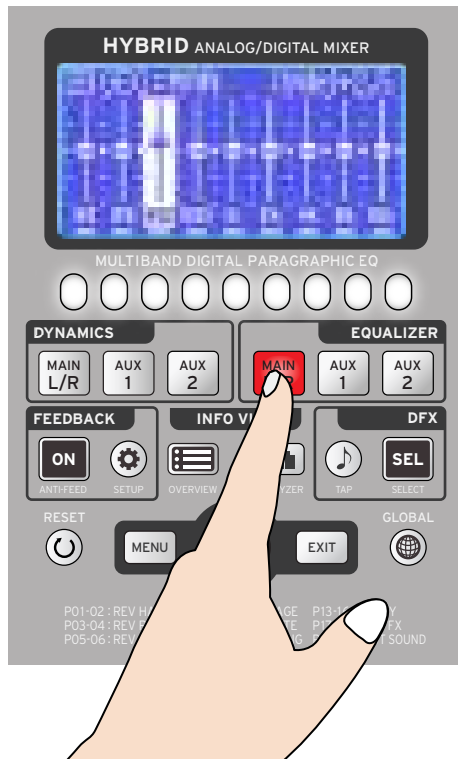

The 9-band equalizer display will appear.

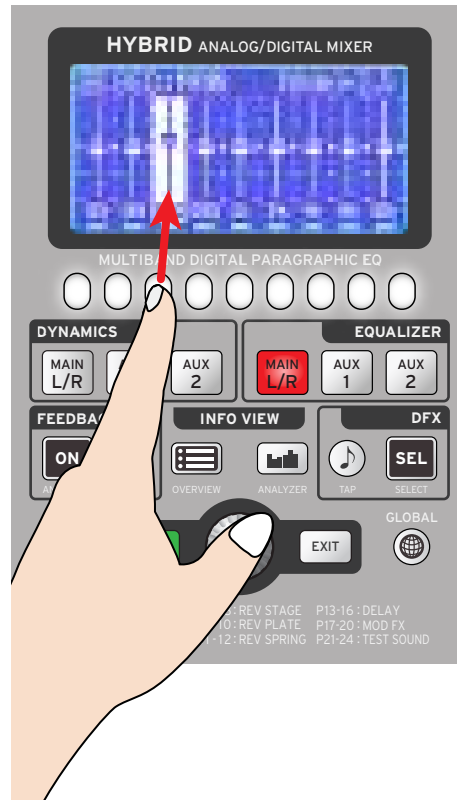

- 2 Press one of the 9 buttons to select a frequency. The corresponding frequency band will change color from blue to white.

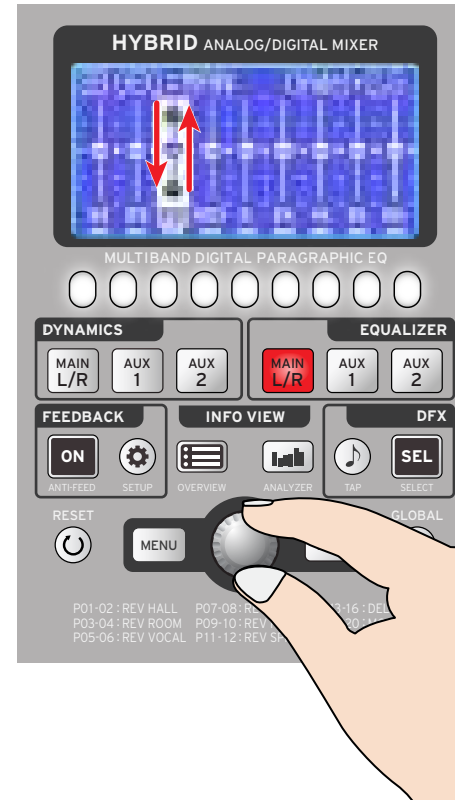

- 3 Rotate the encoder knob to boost or cut the frequency band.
If you wish to *reset* the band, press the **RESET** button.

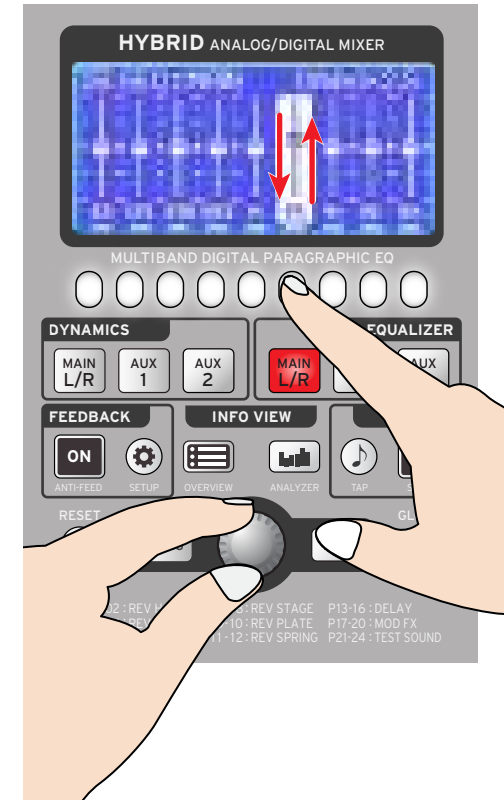

- 4 Select another band to edit if desired **OR** select another EQ destination (Aux 1 or Aux 2) to EQ **OR** exit by pressing **EXIT**.

Adjusting EQ Narrow Mode EQ (31 / 9-band).

1 Follow the steps for selecting Narrow or Wide band EQ. Make sure that Narrow has been highlighted.



2 Press *Select* to choose *Narrow*. That will return you to this screen:



3 Press *Exit*.

That will return you to the screen shown below: The 9-band equalizer display appears, except that in the upper right hand corner it now reads *Narrow*.



Each of the 9 bands now represents a "gateway" to a narrower set of frequency bands.

4 Press a selection button to pick a "gateway".

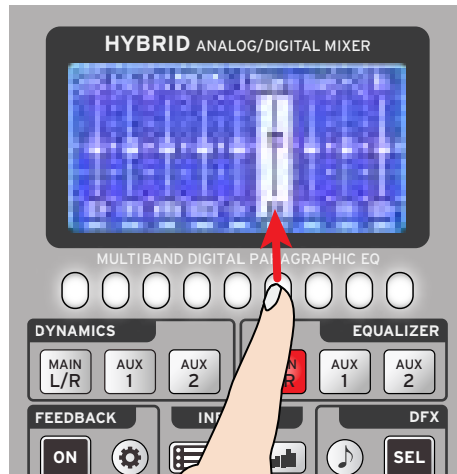

5 **Push down** on the encoder knob to change the screen to 31 / 9 (Narrow) EQ mode.



6 Twist the encoder knob to select a 1/3-octave frequency band within the selected "gateway" frequency range (80Hz to 200Hz in our example).



Adjusting (Narrow Mode) Continued

- 7 **Push down** on the encoder knob to select that 1/3-octave frequency. The screen will "revert" to the 9-band display
- 8 Rotate the encoder knob to boost or cut the frequency.

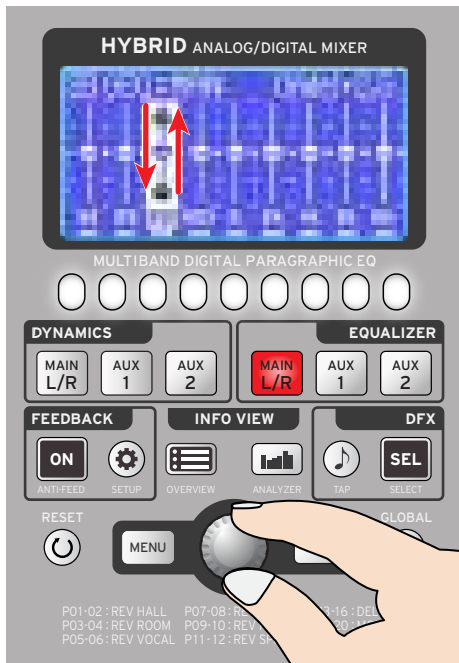

- 9 Press down on the encoder knob to return to the 31 / 9 (Narrow) EQ mode and view the results of your adjustment.

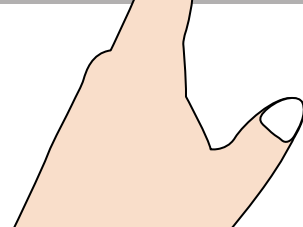

Shows there the EQ is assigned (Main L/R, Aux 1 or Aux 2)

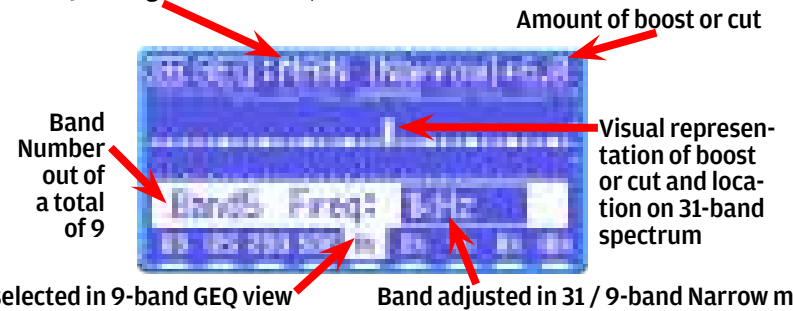

Shows there the EQ is assigned (Main L/R, Aux 1 or Aux 2)

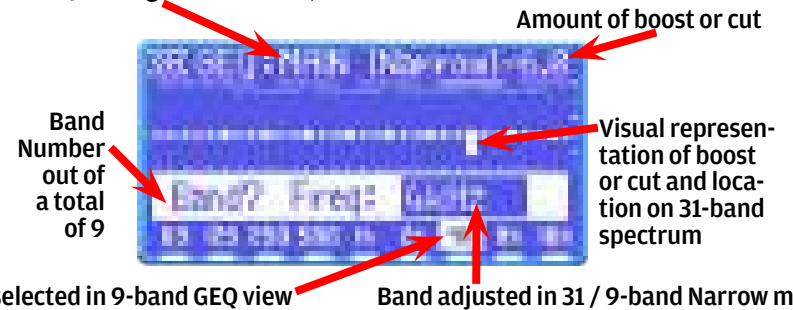

Shows there the EQ is assigned (Main L/R, Aux 1 or Aux 2)

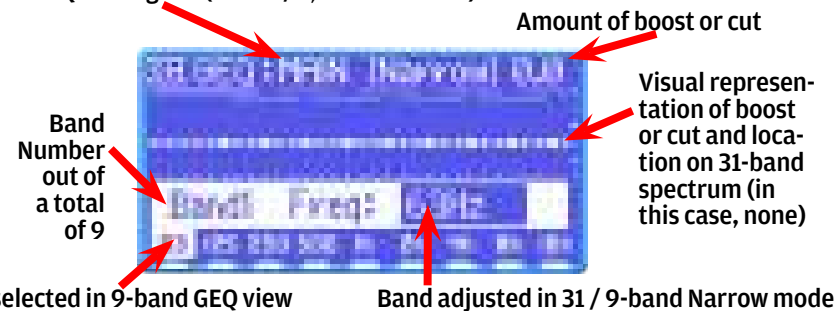

Saving Equalizer settings.

You can save and recall up to 6 EQ settings as *User Types*

- 1 Press the **MENU** button. The settings menu appears.
- 2 Turn the encoder knob to select "*Save as User Setting*", and then press down on the encoder.

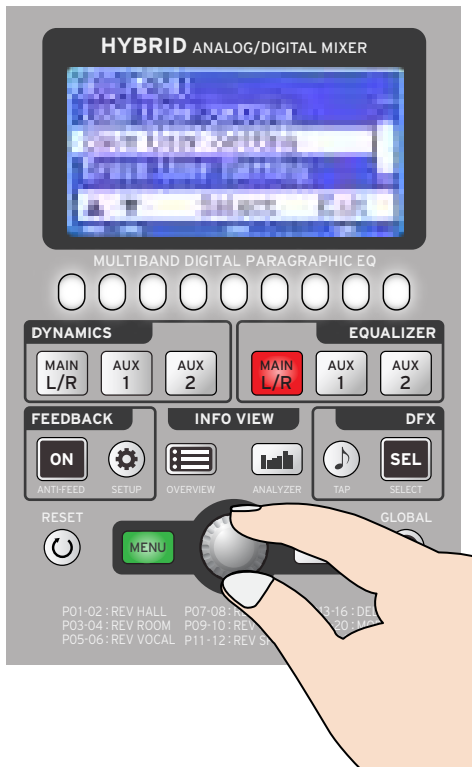

 You can also select and confirm menu items by using "▲", "▼," and the function button indicated as "Select."

If nothing is saved in the number, the display indicates "*Empty*".



Press the function button indicated as "*Save*".

The current content is saved in the specified number.



If you select a number that is already used...



...the new content is overwritten. Pick another *Empty User Setting*.



 To return to the previous screen without saving, press the EXIT button or the function button indicated as "Exit".

Recalling an Equalizer Setting.

If you've gone to the trouble of carefully adjusting all nine 1/3-octave EQ bands (Narrow) to improve room acoustics in a club or sanctuary, you definitely don't want to have to re-set them before every use. That also goes for Aux 1 or Aux 2 EQ settings being fed to floor wedges or in-ears — *recall* instead of resetting!

On the following page is how to recall equalizer settings that you saved.

Recalling an Equalizer Setting (continued)

- 1 In the **EQUALIZER** section, press the **MAIN L/R** button, **AUX1** button, or **AUX2** button to select the bus for which you want to recall equalizer settings.

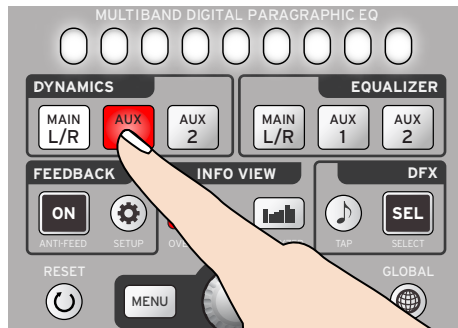

- 2 Press the **MENU** button. The *Settings* menu appears.

- 3 Turn the encoder knob to select "*Load User Setting*," and then press down on the knob.



M You can also select and confirm menu items by using "**▲**," "**▼**," and the function button indicated as "**Select**".

- 4 Turn the encoder knob to select the save destination. Then press the the knob down.

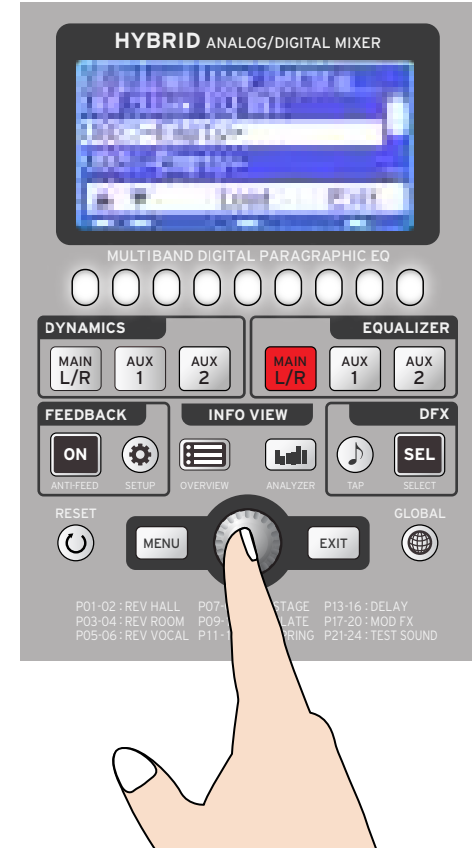

M To return to the previous screen without recalling equalizer settings, press the **EXIT** button or the function button indicated as "**Exit**."

The recalled equalizer settings are applied to the currently selected bus.



Feedback Suppressor: Setting routing options.

The Feedback Suppressor is an automatic notch filter that self-analyzed for feedback and then places a very narrow notch filter in the offending band to reduce feedback. parameter settings. It just works.

Some "feedback suppressors", create digital noise as they operate, ruining the whole concept of natural feedback suppression, KORG has gone far beyond our competitors to create an actual feedback natural suppressor.

What you CAN control is what the Feedback Suppressor acts upon: Main L/R, AUX 1 or AUX 2 (or all three at once).

Applying the Feedback Suppressor on the Main L/R makes perfect sense to reduce unexpected feedback from mic position, or not-so-exact initial level setting.

If you are using Aux 1 and Aux 2 for monitor feeds, we recommend that Feedback Suppression should be always left on. Focused into a floor wedge or in-ear system, intense feedback can contribute to deafness.



Depending on the acoustic environment, the response might be slower, or suppression might not be complete. In this case, you can use the **NARROW BAND** equalizer in conjunction with this to effectively suppress feedback.

- 1 In the **FEEDBACK** section, press the **ANTI-FEED** button. Each time you press the button, the feedback suppressor alternately turns "ON" (enabled) or "OFF" (disabled).



When you turn it "OFF" (disabled), the suppression filter is reset.

- Next, specify the bus that uses the feedback suppressor by pressing the **FEEDBACK** section's **button**. The feedback suppressor's setting screen appears.

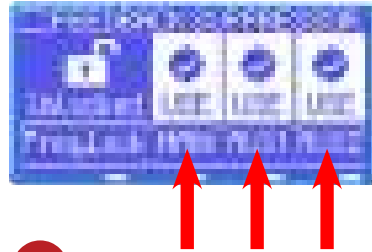
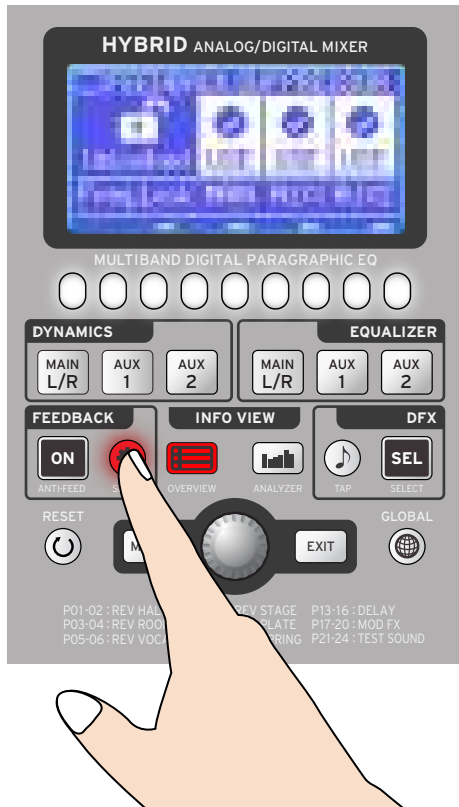

- Press the function buttons indicated as "MAIN," "AUX1," or "AUX2" to switch the setting between "USE" (use) and "OFF" (don't use).

M You can't set all buses to "OFF." Use the **ANTI-FEED** button to turn the feedback suppressor "OFF" (disabled).

Locking the state of the feedback suppressor

Although the feedback suppressor is constantly monitoring the sound and dealing with new feedback, you can stop the monitoring operation and lock the state of the filter frequency settings.

If the locations of the microphones and instruments is fixed, so that new feedback is unlikely to occur, you can lock this after the rehearsal/soundcheck to prevent unintended changes in the sound.

- Press the **FEEDBACK** section's **SETUP** button. The feedback suppressor's setting screen appears.

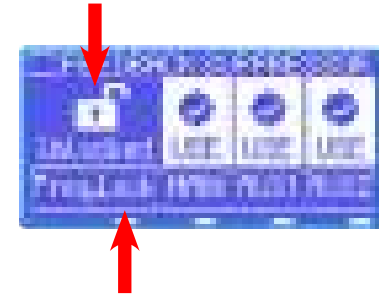

- Press the function button indicated as "Freq.Lock" to switch the setting between "Locked" (locked) and "Unlocked" (not locked).

M If the feedback suppressor is disabled, or if this unit's power is turned off, the setting automatically switches to "Unlocked."

Global menu (scene memory, settings, initialization).

You've set up Mute Groups, added dynamics to Aux 1 and 2, fine-tuned the graphic equalizer, assigned the Feedback Suppressor and customized Hall Warm digital effects.

Do you really want to have to do all of these adjustments *again* for the next gig or service or presentation? Nope.

That's where Global Scene Memory comes in handy. In the **GLOBAL** menu's "Save Scene" and "Memorize Mode," the following settings are saved.

- **MUTE enable/disable**
 - Each channel's MUTE
 - FX MUTE
 - MUTE GROUP
 - BREAK
 - MUTE GROUP content
- **Dynamics**

- **GEQ and DFX settings**
 - ON/OFF
 - Type
 - Parameters
- **FEEDBACK applicable bus(s)**
- **Current screen display**

Saving a Global Scene

- 1 Press the **GLOBAL** button.

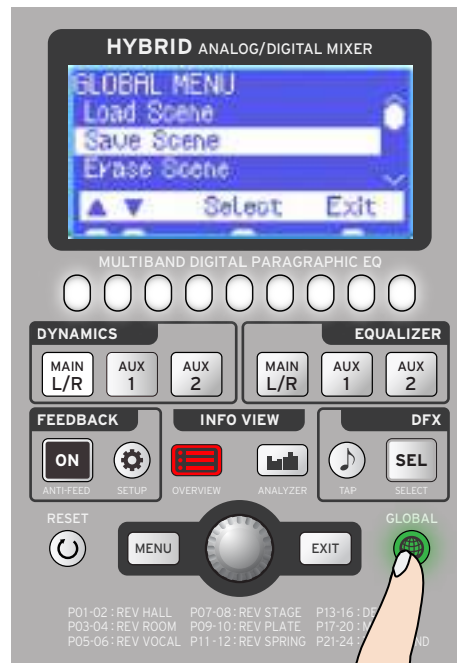

Items in the GLOBAL menu

Load Scene	Recalls settings that were saved in "Save Scene."
Save Scene	Saves settings of the digital section (such as dynamics and equalizer) (maximum 10 types).
Erase Scene	Erases settings that were saved in "Save Scene."
Memorize Mode	Specifies whether the previous settings of the digital section (dynamics and equalizer, etc.) are maintained or reset when this unit is powered-on. Memorize: The previous settings are maintained. Reset: Resets the settings.. <i>If the power is turned off immediately after this operation (approximately 10 seconds), the settings might not be saved.</i>
LCD Contrast	Adjusts the display contrast (brightness) in a range of 1-26.
Level Meter Mode	Specifies the display speed of the level meter. Normal Slow: The meter moves slowly. Normal Fast: The meter moves quickly. Peak Slow: The meter shows peak hold, and moves slowly. Peak Fast: The meter shows peak hold, and moves quickly.
Analyzer Mode	Specifies the display speed of the spectrum analyzer. Normal Slow: The meter moves slowly. Normal Fast: The meter moves quickly. Peak Slow: The meter shows peak hold, and moves slowly. Peak Fast: The meter shows peak hold, and moves quickly.
Reset to Default	Resets the panel settings of the digital section to their default state. (The user memories and scene memories of each effect are not erased.)
Clear User Memory	Clears all user memories and scene memories of each effect.
Factory Reset	Returns this unit to its factory default condition. All memory is erased.
System Update	Executes a system update for this unit. The update can be downloaded from the KORG website. For details on the update procedure, refer to the documents that are included with the update.

- 2 A scrolling menu of **GLOBAL** options will appear.
- 3 Select "*Save Scene*" by scrolling with ▲ and ▼ or the encoder knob.



Press then *Select*.

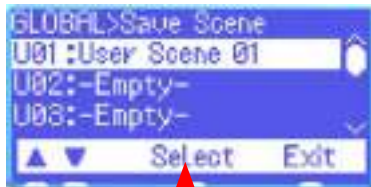

You will be presented with a choice of User "slots".

- 4 Select an un-used slot

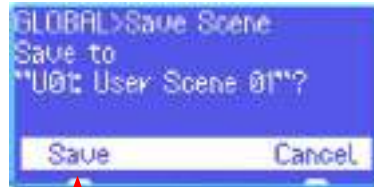

- 5 Save your **GLOBAL** Scene.

Recalling a Global Scene

- 1 Press the **GLOBAL** button.
- 2 Select "*Load Scene*" by scrolling with ▲ and ▼ or the encoder knob.



Press then *Select*.



- 3 Scroll through your saved scenes with ▲ and ▼ or the encoder knob. Select an existing User Scene.

Other GLOBAL options.

While you'll probably use "*Save Scene*", "*Load Scene*" and "*Erase Scene*" the most, the scrolling **GLOBAL** menu gives you access to many other options.



Memorize Mode specifies whether the previous settings of the digital section (dynamics and equalizer, etc.) are maintained or reset when this unit is powered-on.

Memorize: The previous settings are maintained.

Reset: Resets the settings.



LCD Contrast is more useful than you might think — especially if you do gigs in daylight hours...or VERY dark clubs.



Level Meter Mode determines how the main LED ladder displays signals.



- L R
 - OL
 - 15
 - 12
 - 9
 - 6
 - 3
 - 0
 - 3
 - 6
 - 9
 - 12
 - 15
- Normal shows all of the LEDs from -15 to the maximum signal. This is the conventional display mode.
- Slow** and **Fast** are how quickly the display reacts to musical peaks.

Peak just shows the highest level at any moment. This can be handy when you have a lot of other things to look at.

It concentrates the display where it is most important — the highest musical impulses and how close they are to overload.



Analyzer Mode. Although “neither fish nor fowl”, the the Analyzer is definitely a key part of the SoundLink digital section. It gives you a visual display of how much energy there is in each of 24 bands of the audio spectrum.



Normally, it monitors Main L/R output, which can give you a picture of your outgoing signal to the PA. Connect a measurement microphone and the display can show you how the room is “reacting” to the PA. Feedback can be fixed. Bass response can be made less boomy.

Slow and **Fast** Normal and **Slow** and **Fast** Peak definitely behave differently. The Spectrum Analyzer in **Fast** mode reacts so quickly that it might not be

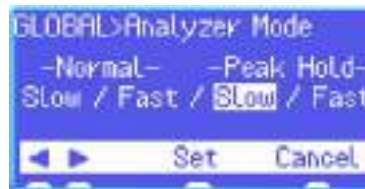

useful in locating “bumps” and “dips” in the overall response. If that is the case, switch to Slow.



Now we’re in the “**Danger! Danger! Warning! Warning!**” thermo-nuclear section. Use these options carefully.

Clear User Memory clears all user memories and scene memories of each effect.

Reset to Default resets the panel settings of the digital section to their default state.

The user memories and scene memories of each effect are not erased.

Factory Reset returns this unit to its factory default condition. **All memory is erased.** It’s like a Neuralizer in Men in Black.

System Update executes a system update for this unit. The update can be downloaded

from the KORG website. For details on the update procedure, refer to the documents that are included with the update.

More on Factory Reset (restoring the factory default settings).

You can also return this unit to its factory-set condition by turning the **POWER** switch on (ON) while holding down the farthest-left function button and the **EXIT** button simultaneously.

Notes

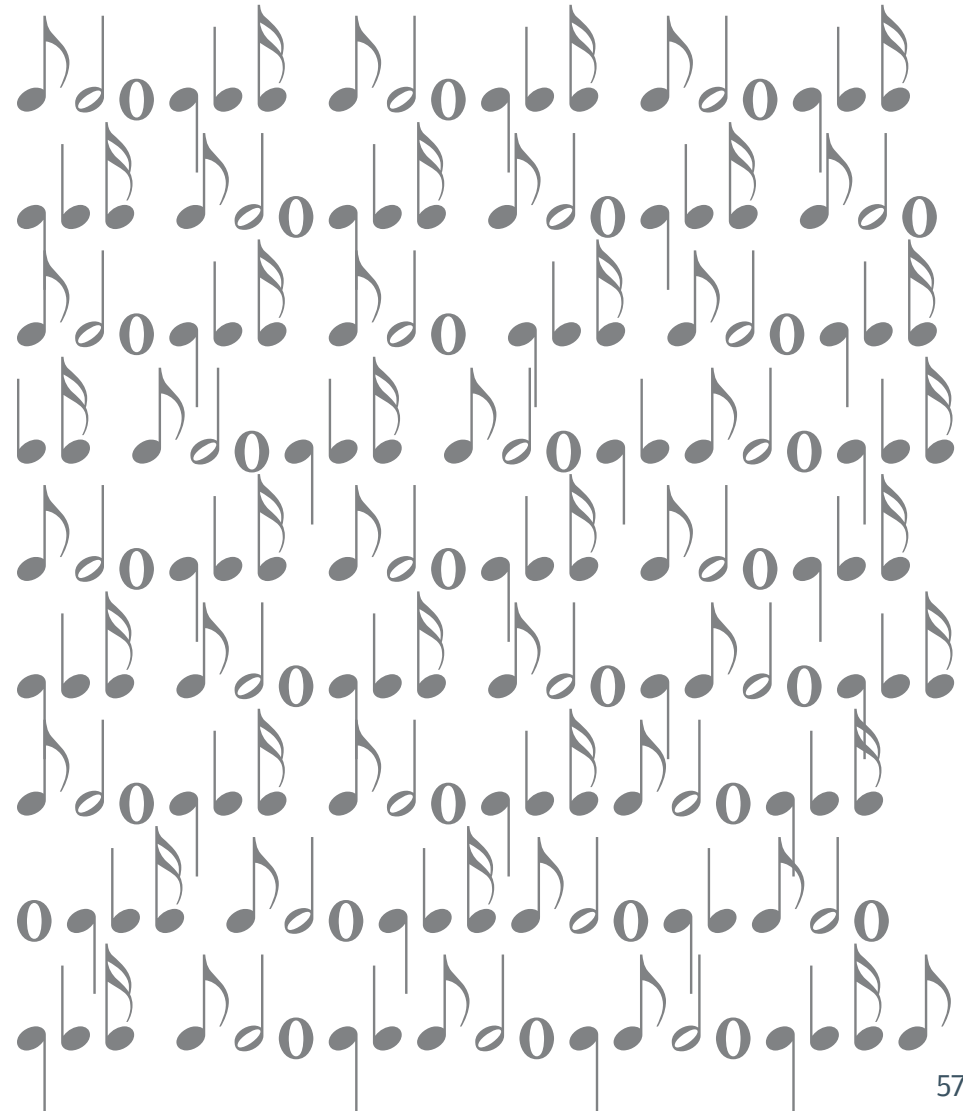

Trouble Shooting

If this unit stops operating normally, check the following items.
If taking the directed action does not correct the problem, or if there is a problem not listed here, disconnect the power cord from the electrical outlet and contact KORG customer service.

Problem	Cause	Action
The power won't turn on.	This unit is connected to a generator or to a switched power strip, and the power source is switched off.	Turn on the power of the generator or the switched power strip.
No sound is output.	External equipment (instrument, microphone, etc.) is not connected correctly.	Check the connections to the external equipment.
	The cable used for connection to external equipment (instrument, microphone, etc.) is shorted or broken.	Check the connections to the external equipment. Replace the cable as necessary.
	Gain or faders are not adjusted appropriately.	Use the appropriate channel's GAIN knob and channel fader, the SUB GROUP MASTER faders, or the MAIN MIX (L/R) fader to adjust the levels.
	Output is disabled for the corresponding channel.	Check the state of the corresponding channel's MUTE button and bus assign switches, the MUTE GROUP buttons, and the BREAK button.
No sound from the AUX OUT output jacks.	The signal levels of the AUX 1-4 buses are not adjusted appropriately.	Use the corresponding channel's AUX (1-4) SEND knobs to adjust the signal level.
No sound from the PHONES jack and MONITOR OUT jack.	The AFL function of the corresponding bus is disabled.	Use the AFL switch of the corresponding bus to enable the AFL function.
	The PFL function of an unused channel is enabled.	Use the PFL switch of the corresponding channel to disable the PFL function.

The sound is extremely quiet, or is distorted or noisy.	Gain or faders are not adjusted appropriately.	Use the appropriate channel's GAIN knob and channel fader, the SUB GROUP MASTER faders, or the MAIN MIX (L/R) fader to adjust the levels.
	The output level of an external device connected to this unit is not appropriate.	Adjust the output level of the external device.
	The compressor or effect is applied excessively.	Use the corresponding channel's COMP knob or FX SEND knob to adjust each effect.
	An external device is connected to both the XLR jack and phone jack of the same channel.	Do not connect an external device to both jacks. Use only one of the jacks.
The sound is unsteady.	A condenser mic is being used with phantom power turned off.	Turn the 48V MIC PHANTOM switch on.
	The compressor is applied excessively.	Use the corresponding channel's COMP knob to adjust the compression effect.
	There is volume inconsistency between the left and right of the stereo audio.	Volume balance (left/right) is not adjusted appropriately.
Different cables are being used for the left and right connections with the external device.		Use the same cables for left and right when connecting an external device.
Level meter does not work.	The PFL function of an unused channel is enabled.	Use the PFL switch of the corresponding channel to disable the PFL function.
Sound from an iPhone/iPad is not output.	The iPhone/iPad is insufficiently charged.	Charge the iPhone/iPad and then try again.
	The iPhone/iPad connected to the USB port is not supported by this unit.	Use an iPhone/iPad that is supported by this unit (page <OV>).

DYN (dynamics)

Type	Details	Parameter / effect
P01: Limiter	Limits excessive input.	
P02: Comp Hard P03: Comp Soft	Limits high levels to make the sound more consistent and improve the loudness. "Comp Hard" applies the effect more strongly, and "Comp Soft" applies the effect more gently.	Attack: Time until compression begins Sens: Sensitivity of operation
P04: NsGate Hard P05: NsGate Soft	Reduces noise by turning down the output when the input level is low. "NsGate Hard" applies the effect more strongly, and "NsGate Soft" applies the effect more gently.	Release: Time until the output is reduced Sens: Sensitivity (threshold that is considered to be noise)

GEQ (graphic equalizer)

Mode	Contents
Wide (default)	A basic wide-type graphic equalizer. Since each band is wide, nine bands cover the entire frequency range, making this suitable for adjusting the overall sound. The frequency of each band is fixed.
Narrow	A high-class 1/3rd octave graphic equalizer. Since each band is narrow, this allows you to make detailed adjustments as appropriate for the acoustics of the live venue, or to increase the feedback margin. The frequency of each of the nine bands can be adjusted, and you can select the frequencies from the standard steps of a typical 31-band rack-mounted EQ.

DFX (digital effect)

Type	Details	Parameter / effect
P01: Rev Hall P02: Rev Hall Warm	Provides the reverberation of a hall. "Rev Hall Warm" provides a warm tone.	
P03: Rev Room P04: Rev Room Warm	Provides the reverberation of a small room. "Rev Room Warm" provides a warm tone.	
P05: Rev Vocal P06: Rev Vocal Warm	Provides reverberation suitable for vocals. "Rev Vocal Warm" provides a warm tone.	Time: Time that the reverberation continues HiDamp: High frequency attenuation of the reverberant sound
P07: Rev Stage P08: Rev Stage Warm	Provides the reverberation of a mid-sized stage. "Rev Stage Warm" provides a warm tone.	
P09: Rev Plate P10: Rev Plate Warm	Provides the reverberation of a plate reverb unit. "Rev Plate Warm" provides a warm tone.	
P11: Rev Spring P12: Rev Spring Warm	Provides the distinctive reverberation of a spring reverb unit of the type often built into a guitar amp. "Rev Spring Warm" provides a warm tone.	Time: Time that the reverberation continues Sway: Amount of modulation for the springs
P13: Delay Analog	Adds a delayed sound. This models a warm-toned analog delay.	
P14: Tape Echo	Adds a delayed sound. This models a tape echo that balances warmth and clarity.	Time: Delay time Feedback: Amount of repeated delay sounds
P15: Delay Standard	Adds a delayed sound.	
P16: Delay SDD3000	Adds a delayed sound. This produces a clear delay sound modeled on the Korg SDD3000 digital delay.	

Digital Effects

Type	Details	Parameter / effect
P17: Chorus	Adds pitch-modulated sound to the original sound, creating greater depth. A slow "Speed" creates a unison (duet) effect, and a fast "Speed" creates a vibrato effect.	Speed: Speed of modulation Depth: Depth of modulation
P18: Flanger	Produces a twisting effect reminiscent of a jet airplane passing overhead.	Depth of modulation
P19: Exciter	Created more brilliance by enhancing upper harmonic content.	Tone: Frequency region to boost
P20: Sub Bass	Strengthens low-frequency sounds such as a bass drum by creating sub-harmonic content.	Sens: Sensitivity at which the input is followed Decay: Strength of decay for the sub-bass sound
P21: Sine 1kHz	This is a test tone (1 kHz sine wave).	Level: Signal level
P22: Sweep Slow	This is a test tone (swept sine wave).	To prevent sound from being produced unintentionally, a default value of "-INF" (silence) is specified when you select this type.
P23: Sweep Fast	"Sweep Slow" changes slowly, and "Sweep Fast" changes faster.	
P24: Noise	This is a test tone (white/pink noise).	Color: Type of noise Level: Signal level To prevent sound from being produced unintentionally, a default value of "-INF" (silence) is specified when you select this type.

Memory Settings

Section	Memory number	Type
DYN (DYNAMICS)	U01-U10	User type (common to MAIN, AUX1, and AUX2)
GEQ (Graphic EQ)	U01-U06	User settings (common to MAIN, AUX1, and AUX2)
DFX	U01-U30	User type
GLOBAL	U01-U10	Scene memory

Settings that can be saved

In the **GLOBAL** menu's "Save Scene" and "Memorize Mode," the following settings are saved.

- **MUTE** enable/disable: Each channel's **MUTE**, **FX MUTE**, **MUTE GROUP**, and **BREAK**
- **MUTE GROUP** program content
- **DYN**, **GEQ**, and **DFX** settings: **ON/OFF**, type, parameters
- **FEEDBACK** settings: Applicable bus
- Current screen display

Block Diagram

MW-1608 / MW-2408

MONO CH IN MW-1608/2408 : 1-8ch

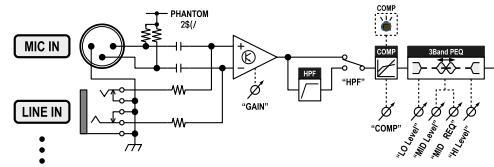

STEREO CH IN MW-1608 : 9/10 - 15/16ch MW-2408 : 9/10 - 23/24ch

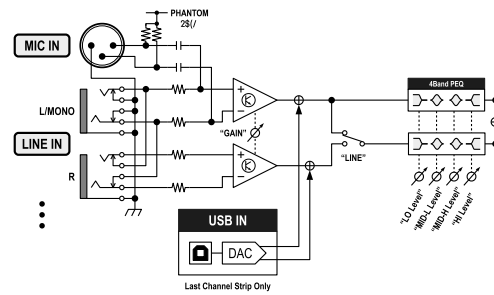

STEREO IN MW-1608 : 17/18ch MW-2408 : 25/26ch

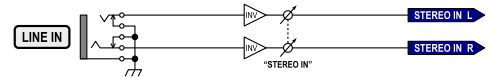

TALKBACK IN

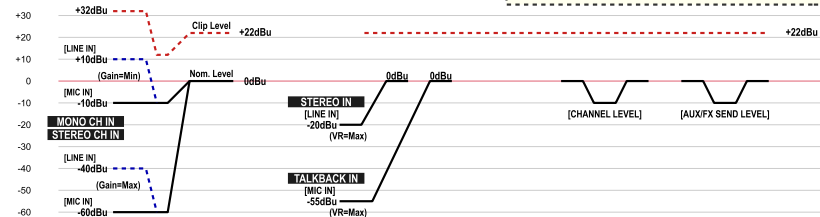
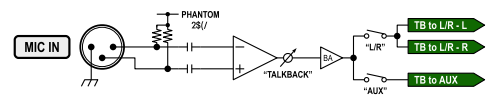

AUDIO SIGNAL BUS

MAIN SUB GROUP AUX/FX MON

L R * 2 3 \$ % & ' (* 2 3 \$ L R

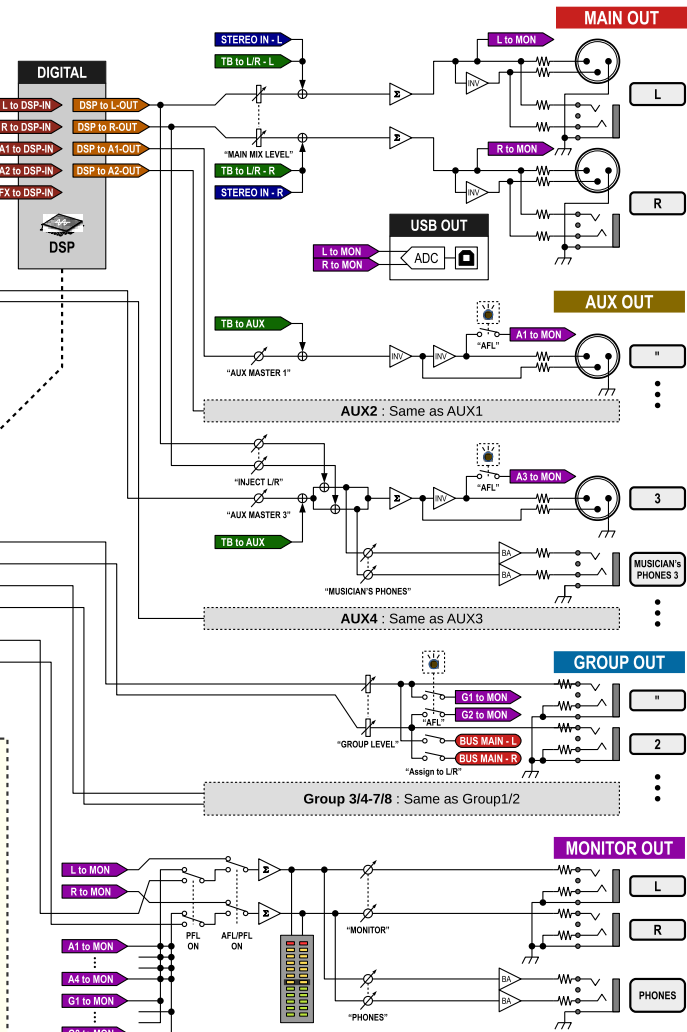
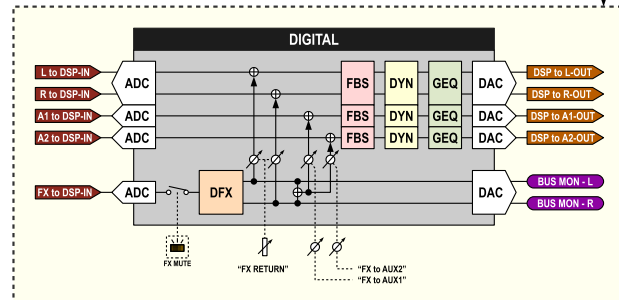
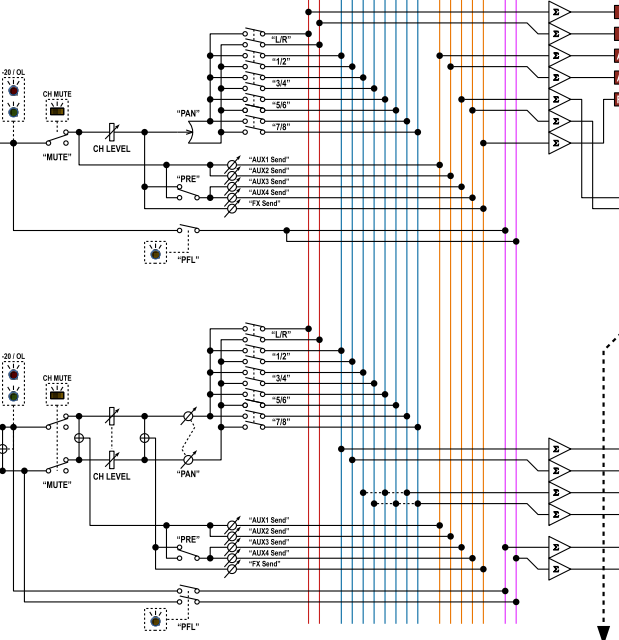

Specifications

Frequency response		20 Hz - 20 kHz	+0.5/-1.5 dB	Nominal output, 1 kHz reference	
Total harmonic distortion (THD + N)		MAIN OUT	0.004 %	1 kHz +24 dBu, GAIN=minimum	
Noise (A-weighted)	Equivalent input noise	INPUT to MAIN OUT	-128 dBu	MIC IN, GAIN=maximum	
	Residual noise	MAIN OUT	-94 dBu	Master fader: minimum	
		SUB GROUP OUT	-102 dBu		
		AUX OUT	-93 dBu		
	Bus noise	MAIN OUT	-70 dBu	Master fader: nominal Bus assign switches: off	
		SUB GROUP OUT	-80 dBu		
AUX OUT (1-2)		-64 dBu	Master knob: nominal AUX SEND knob: minimum		
AUX OUT (3-4)		-69 dBu			
Analog input specifications	Impedance		Input level		Connector specifications
	Input	Applicable source	Nominal level	Maximum level	
MIC IN (channel)	3k Ω	50 -600 Ω	-10 to -60 dBu	+12 to -38dBu	Form: XLR-3-31 Signal: monaural (balanced)
LINE IN (channel)	30k Ω	600 Ω	+10 - -40 dBu	+32 to -18 dBu	Form: 6.3 mm phone jack (TRS) Signal: monaural (balanced)
MIC IN (TALKBACK)	1.1k Ω	50 -600 Ω	-55 dBu	-18 dBu	Form: XLR-3-31 Signal: monaural (balanced)
STEREO IN	2k Ω	600 Ω	-	-3 dBV	Form: 3.5 mm phone jack (TRS) Signal: stereo (unbalanced)
Crosstalk	Between input and output (MAIN L/R)	-70 dBu	1 kHz, Bandpass Filter		
	Between adjacent input channel strips	-95 dBu	1 kHz, Bandpass Filter		

Analog output specifications	Impedance		Output level		Connector specifications
	Output	Rated impedance	Nominal	Maximum	
MAIN OUT	75 Ω	600 Ω	+4 dBu	+26 dBu	Form: XLR-3-32, 6.3 mm phone jack (TRS) Signal: monaural (balanced)
SUB GROUP OUT	75 Ω	10k Ω	+4 dBu	+22 dBu	Form: 6.3 mm phone jack (TRS) Signal: monaural (impedance balanced)
MONITOR OUT	75 Ω	10k Ω	+4 dBu	+22 dBu	Form: 6.3 mm phone jack (TRS) Signal: monaural (impedance balanced)
PHONES OUT	110 Ω	32 Ω	-	100 mW @32 Ω	Form: 6.3 mm phone jack (TRS) Signal: stereo (unbalanced)
AUX OUT	75 Ω	600 Ω	+4 dBu	+26 dBu	Form: XLR-3-32 Signal: monaural (balanced)
MUSICIAN'S PHONES OUT	110 Ω	32 Ω	-	100 mW @32 Ω	Form: 6.3 mm phone jack (TRS) Signal: stereo (unbalanced)
Digital input/output specifications	Applicable standards	Audio format	Connector specifications		
USB IN/OUT	USB Audio Class 1.0	44.1/48 kHz, 16/24-bit, stereo	Form: USB Type-B Signal: USB 2.0		

Specifications

Audio channels			
Input	Channels	Monaural strips	8 (8 ch)
		Stereo strips	MW-2408: 8 (16 ch) MW-1608: 4 (8 ch)
	Auxiliary inputs	STEREO IN	1 (2 ch)
		TALKBACK	1
Internal buses		MAIN	2 ch
		SUB GROUP	8 ch
		AUX	4 ch
		FX	1 ch
		MONITOR	2 ch
Output	Line	MAIN	2 ch
		SUB GROUP	8 ch
		AUX	4 ch
		MONITOR	2 ch
	Headphones	MUSICIAN'S PHONES	2
		PHONES	1
USB		USB IN	1 (2 ch)
		USB OUT	1 (2 ch)

Master functions, System functions		
Signal monitor	Level meter	2-row x 12-point LE, peak hold function Levels: 0L, 15, 12, 9, 6, 3, 0, -3, -6, -9, -12, -15
	ANALYZER	24-band spectrum analyzer, peak hold function
Feedback suppressor		Three high-speed feedback suppressors Bus selection function, operation lock function
Mute control	MUTE GROUP	Programmable mute groups Memories: 4 mute groups
	BREAK	Mutes all bus routes of the input section * Except for MONITOR (PFL) route
Scene memory		Save and recall digital section and mute settings Memories: 10 user scenes
Power supply		
Rated input voltage		AC100 - 240 V, 50/60 Hz
Maximum power consumption		45 W
Phantom power supply		+48 V
Recommended operating temperature range		
		0 ° C to 40 ° C / 32 ° F to 110 ° F

Specifications

Physical		
Dimensions * Excluding protrusions	MW-2408	W480 mm x H187 mm x D530 mm * Unit width excluding side panels is 440 mm
	MW-1608	W396 mm x H187 mm x D530 mm * Unit width excluding side panels is 356 mm
Weight	MW-2408	20.5 lbs / 9.3 kg
	MW-1608	17.0 lbs / 8.0 kg
Included items and options		
Included items	Power cord, Quick Start Guide, iZotope RX Elements license card	
Options	Rack mount hardware	MW-001 (for MW-2408 only)
	Foot switch	PS-1 or PS-3 pedal switch



Specifications and appearance are subject to change without notice.

NOTE

MW-2408 Rack Mounting

Rack mounting (MW-2408 only)

To install this unit in a rack, you can use a dedicated mixer bracket made by KORG (sold separately only for use with the MW-2408). Install the unit in a standard EIA-specification 19-inch rack. A minimum of 12U (approximately 533 mm) of space is required for rack installation. To leave room for connecting cables to the back panel, we recommend that you allow 14U (approximately 623 mm) of space. Before you begin installation, consider cabling and ventilation, and make sure that there is sufficient space.

- 

Two or more adults must work together when installing this unit in a rack.
- 

Allow sufficient space (10 cm or more) around the unit to ensure ventilation and to prevent heat buildup inside the unit. If other equipment is also installed in the rack, leave 1U or more of space between this unit and other units.
- 

Heat buildup might cause malfunction or fire. Before installing this unit in a rack, disconnect all cables from the unit.
- 

Cables left connected might cause the unit to tip over or nearby objects to fall, possibly causing electric shock or malfunction.

MW-2408 Rack Mounting

- 1 Use a screwdriver to remove the screws (6 locations) from the side of this unit, and detach the left and right side panels.

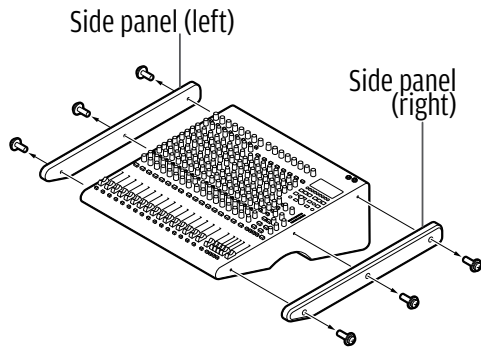

- 2 Using the screws included with the bracket, attach the left and right brackets to this unit.

 Use only the screws included with the bracket, and fasten them firmly to this unit.

 If you use different screws, it might not be possible to tighten them securely, allowing the unit to fall and possibly cause injury or damage.

- 3 Install the unit in the rack.

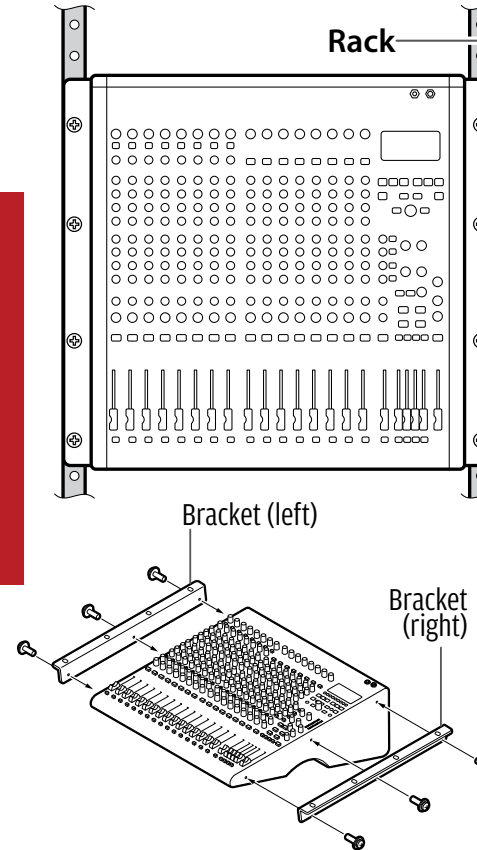

KORG

© 2020 KORG, All Rights Reserved. All other trademarks are property of their respective holders.

IMPORTANT NOTICE TO CONSUMERS

This product has been manufactured according to strict specifications and voltage requirements that are applicable in the country in which it is intended that this product should be used. If you have purchased this product via the internet, through mail order, and/or via a telephone sale, you must verify that this product is intended to be used in the country in which you reside.

WARNING: Use of this product in any country other than that for which it is intended could be dangerous and could invalidate the manufacturer's or distributor's warranty. Please also retain your receipt as proof of purchase otherwise your product may be disqualified from the manufacturer's or distributor's warranty.