



# CH-2537TXWPEU

3×1 HDMI/VGA to HDBaseT Switcher  
with Event Automation (EU 2-Gang)



Operation Manual



## DISCLAIMERS

The information in this manual has been carefully checked and is believed to be accurate. Cypress Technology assumes no responsibility for any infringements of patents or other rights of third parties which may result from its use.

Cypress Technology assumes no responsibility for any inaccuracies that may be contained in this document. Cypress also makes no commitment to update or to keep current the information contained in this document.

Cypress Technology reserves the right to make improvements to this document and/or product at any time and without notice.

## COPYRIGHT NOTICE

No part of this document may be reproduced, transmitted, transcribed, stored in a retrieval system, or any of its part translated into any language or computer file, in any form or by any means—electronic, mechanical, magnetic, optical, chemical, manual, or otherwise—without express written permission and consent from Cypress Technology.

© Copyright 2018 by Cypress Technology.

All Rights Reserved.

## TRADEMARK ACKNOWLEDGMENTS

All products or service names mentioned in this document are trademarks of the companies with which they are associated.





## SAFETY PRECAUTIONS

Please read all instructions before attempting to unpack, install or operate this equipment and before connecting the power supply. Please keep the following in mind as you unpack and install this equipment:

- Always follow basic safety precautions to reduce the risk of fire, electrical shock and injury to persons.
- To prevent fire or shock hazard, do not expose the unit to rain, moisture or install this product near water.
- Never spill liquid of any kind on or into this product.
- Never push an object of any kind into this product through any openings or empty slots in the unit, as you may damage parts inside the unit.
- Do not attach the power supply cabling to building surfaces.
- Use only the supplied power supply unit (PSU). Do not use the PSU if it is damaged.
- Do not allow anything to rest on the power cabling or allow any weight to be placed upon it or any person walk on it.
- To protect the unit from overheating, do not block any vents or openings in the unit housing that provide ventilation and allow for sufficient space for air to circulate around the unit.
- Please completely disconnect the power when the unit is not in use to avoid wasting electricity.

## VERSION HISTORY

REV.	DATE	SUMMARY OF CHANGE
VS1	2018/12/21	Final technical review



# CONTENTS

<b>1. Introduction</b> .....	<b>1</b>
<b>2. Applications</b> .....	<b>1</b>
<b>3. Package Contents</b> .....	<b>2</b>
<b>4. System Requirements</b> .....	<b>2</b>
<b>5. Features</b> .....	<b>2</b>
<b>6. Operation Controls and Functions</b> .....	<b>4</b>
6.1 Front Panel .....	4
6.2 Rear Panel.....	5
6.3 WebGUI Control .....	6
6.6.1 Switch Tab.....	8
6.3.2 Automation Tab .....	10
6.3.3 EDID Settings Tab .....	12
6.3.4 Systems Settings Tab .....	14
6.4 Serial Control (Via Receiver) .....	16
6.5 Telnet Control .....	16
6.6 RS-232 and Telnet Commands .....	17
<b>7. Connection Diagram</b> .....	<b>31</b>
<b>8. Specifications</b> .....	<b>32</b>
8.1 Basic Specifications .....	32
8.2 Video Specifications.....	33
8.3 Audio Specifications .....	35
8.3.1 Digital Audio .....	35
8.3.2 Analog Audio .....	35
8.4 Cable Specifications .....	36
8.5 HDBaseT Features.....	36
<b>9. Acronyms</b> .....	<b>37</b>





## 1. INTRODUCTION

This HDBaseT Wall Plate Switch with Signal Management is an HDMI and VGA switch with audio embedding and HDBaseT output. The wall plate is designed for use with EU two-gang sized enclosures. This Transmitter can send uncompressed high-definition video/audio over a single cable up to a distance of 100 meters at 1080p@60Hz. The HDMI inputs support resolutions up to 4K@60Hz (4:4:4, 8-bit) and the VGA input supports resolutions up to WUXGA (RB). With the use of the 3.5mm audio input, stereo audio may be embedded with VGA or DVI/HDMI sources as well. Despite HDBaseT's 10.2Gbps bandwidth limitation, high bandwidth 4K UHD HDMI video sources, up to and including 4K@60Hz (4:4:4, 8-bit), can be supported and will be automatically converted to 8-bit color, or the 4:2:0 color space when necessary.

Signal management features such as automatic switching based on input signal and hot plug detection enable convenient hands-free operation. A multi-function button on the face of the unit provides access to an information OSD as well as allowing manual input selection. Additional functionality such as EDID management, HDCP management and basic signal event automation (which can send customized RS-232 or CEC commands to external devices automatically) is also available.

This Transmitter may be powered locally or via 48V PoH from a compatible HDBaseT Receiver, which allows for greater flexibility in installations. The unit can be controlled via the front panel button with OSD, WebGUI, and Telnet. When paired with a compatible Receiver RS-232 control also becomes available making it exceptionally versatile.

## 2. APPLICATIONS

- Household entertainment sharing and control
- Lecture halls, auditoriums and classroom
- Houses of worship
- Conference rooms and boardrooms
- Hotel event spaces

### 3. PACKAGE CONTENTS

- 1×3 by 1 HDMI/VGA to HDBaseT Switcher (EU 2-Gang)
- 1×Operation Manual

### 4. SYSTEM REQUIREMENTS

- HDMI or VGA source equipment such as media players, video game consoles, PCs, or set-top boxes.
- A compatible HDBaseT Receiver is required. An HDBaseT Receiver capable of supplying 48V PoH is recommended.
- The use of "Premium High Speed" HDMI cables, and industry standard Cat.6, Cat.6a or Cat.7, is highly recommended.

### 5. FEATURES

- HDMI 2.0 and DVI 1.0 compliant
- HDCP 1.x and 2.2 compliant
- 2 HDMI inputs
- 1 VGA input with 3.5mm mini-jack audio input
- Wall plate is designed for EU two-gang sized enclosures
- Supports HDMI input resolutions up to 4K@60Hz (4:4:4, 8-bit)
- Supports VGA input resolutions up to WUXGA (RB)
- Analog stereo audio may be embedded with VGA or DVI/HDMI sources
- HDBaseT output supports resolutions up to 4K@60Hz (4:2:0, 8-bit) with automatic color space conversion of 4K@50/60Hz (4:4:4, 8-bit) or 4K@any (10/12-bit) sources
- Supports CEC bypass
- HDBaseT feature support: HD Video and Audio, 100BaseT Ethernet, and 48V PoH (PD)
- HDBaseT output transmits video, audio and data over a single Cat.5e/6/7 cable and can reach distances up to 100m/328ft at 4K when using Cat.6a/7
- Supports pass-through of many audio formats including LPCM 2.0/5.1/7.1, Bitstream, and HD Bitstream



- User activated information OSD
- Supports manual input selection or automatic input selection with hot plug detection
- Basic signal event automation (via RS-232 or CEC w/ compatible Receiver)
- Front panel LEDs indicate HDCP mode, input source, link state, and power
- Unit may be powered locally or via 48V PoH from a compatible HDBaseT Receiver
- Controllable via a multi-function front panel button with OSD, or via WebGUI, Telnet, and RS-232 (w/ compatible Receiver only)

## 6. OPERATION CONTROLS AND FUNCTIONS

### 6.1 Front Panel

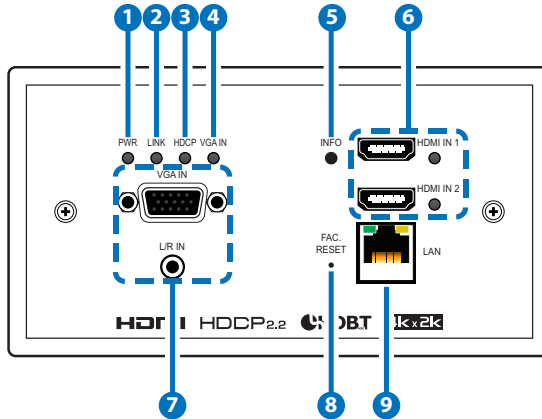

- 1 PWR LED:** This LED will illuminate to indicate the unit is on and receiving power.
- 2 LINK LED:** This LED will illuminate when the unit is on, receiving power, and has successfully linked to a compatible Receiver.
- 3 HDCP LED:** This LED indicates the HDCP mode of the current input. Green indicates Follow Display mode, orange indicates Follow Source mode, off indicates HDCP support is disabled.
- 4 VGA IN LED:** This LED will illuminate when the VGA input is selected.
- 5 INFO Button:** A short press of this button will switch between the available inputs. Pressing and holding this button for 2 seconds will activate the information OSD.
- 6 HDMI IN 1 & 2 Ports and LEDs:** Connect to HDMI source equipment such as a media player, game console or set-top box. The appropriate LED will illuminate when that HDMI input is selected.
- 7 VGA IN Port:** Connect to VGA source equipment such as a PC or laptop.  
**L/R IN Port:** Connect to the stereo analog output of a device such as a CD player or PC for embedding into the HDBaseT output.

- 8 **FAC. RESET Pinhole:** Press and hold for 5 seconds to reset the unit to its factory defaults.
- 9 **LAN Port:** Connect to an Ethernet supporting device or to your local network, as appropriate, to extend the network to both ends of the HDBaseT connection and to control the unit.

## 6.2 Rear Panel

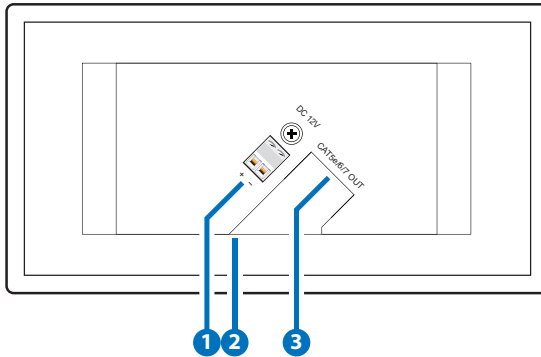

- 1 **DC 12V Port:** Plug the 12V DC power adapter into this terminal block and connect it to an AC wall outlet for power. (Optional)  
*Note: This connection is not required if the unit is receiving power via 48V PoH from the Receiver.*
- 2 **SERVICE Port:** This port is reserved for firmware update use only.
- 3 **CAT5e/6/7 OUT Port:** Connect to a compatible HDBaseT Receiver with a single Cat.5e/6/7 cable for transmission of all data signals. 48V PoH will also be supplied when connected to a compatible PSE Receiver.  
*Note: The 48V PoH function is designed to receive power from compatible Receiver units only. Other brands of Receiver may not be compatible.*

## 6.3 WebGUI Control

### • Device Discovery

Please obtain the “Device Discovery” software from your authorized dealer and save it in a directory where you can easily find it.

Connect the unit and your PC/Laptop to the same active network and execute the “Device Discovery” software. Click on “Find Devices on Network” and a list of devices connected to the local network will show up indicating their current IP address.

*Note: The unit's default IP address is 192.168.1.50.*



Product Name	Description	IP Address	MAC Address

By clicking on one of the listed devices you will be presented with the network details of that particular device.

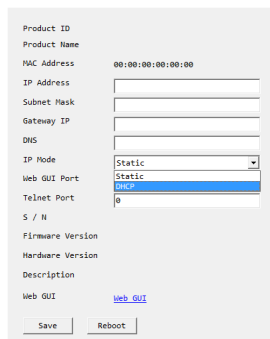

Product ID  
 Product Name  
 MAC Address 00:00:00:00:00  
 IP Address  
 Subnet Mask  
 Gateway IP  
 DNS  
 IP Mode Static  
 Web GUI Port Static  
 Telnet Port 0  
 S / N  
 Firmware Version  
 Hardware Version  
 Description  
 Web GUI [Web GUI](#)  
 Save Reboot

- 1) IP Mode:** If you choose, you can alter the static IP network settings for the device, or switch the unit into DHCP mode to automatically obtain proper network settings from a local DHCP server. To switch to DHCP mode, please select DHCP from the IP mode drop-down, then click “Save” followed by “Reboot”.
- 2) WebGUI Hotkey:** Once you are satisfied with the network settings, you may use them to connect via Telnet or WebGUI. The network information window provides a convenient link to launch the WebGUI directly.

- **WebGUI Overview**

After connecting to the WebGUI's address in a web browser, the login screen will appear. Please enter the appropriate user name and password then click "Submit" to log in.

*Note: The default user name and password is "admin".*

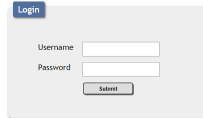

A login form with a blue "Login" tab at the top left. Below it are two input fields: "Username" and "Password". At the bottom of the form is a "Submit" button.

On the left side of the browser you will see the following menu tabs where all primary functions of the unit (Switch, Automation, EDID Settings and System Settings) are controllable via the built in WebGUI. The individual functions will be introduced in the following sections.

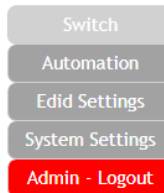

Clicking the red "Logout" tab will automatically log the currently connected user out of the WebGUI and return to login page.

## 6.6.1 Switch Tab

This tab provides video/audio routing control as well as control over HDCP behavior, freerun settings, and naming of the Inputs and Output. To assign a new video route, please click the Output button and then click on the button of the preferred Input port to route. As you select each button they will change their color to orange. The new route will become active immediately and the routing information displayed on the buttons will change accordingly.

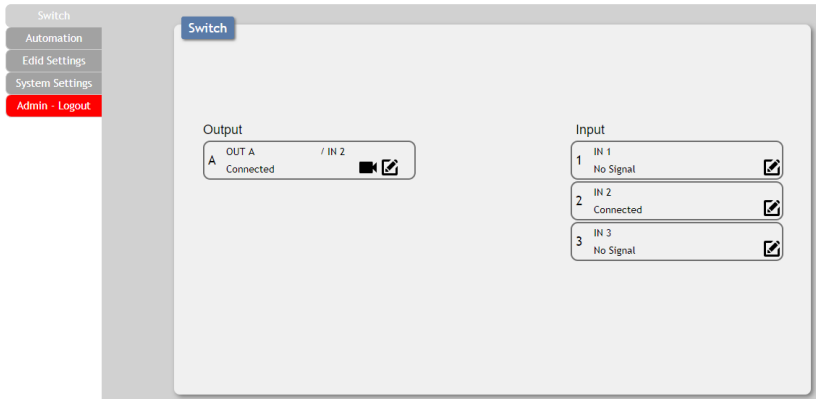

- 1) **Output:** Click on the Output button to begin routing selection followed by the selection of the preferred Input. Click on the Camera icon (📷) to mute or unmute the output. Click the Edit icon (✎) to modify additional Output settings.

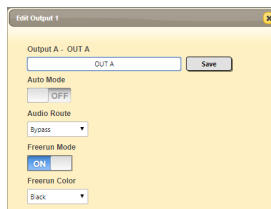

- 2) **Edit Output:** This window provides options to rename the Output, enable auto switching, set audio routing, and configure freerun.
  - **Output Name:** Provides a way to change the name of the Output port. Click on “Save” to confirm and activate any changes.
  - **Auto Mode:** Enable or disable the auto input switching mode.



- **Audio Route:** Control the audio used when the HDMI input is active. Selecting “Bypass” will use the HDMI signal’s normal audio. Selecting “External” will use the analog stereo audio.
  - **Freerun Mode:** Enable or disable the video freerun function. When this is enabled, the selected freerun color will be displayed on the screen if there is no live source on the selected input.
  - **Freerun Color:** Select the color to display when freerun is active. Available choices are: Black, Red, Blue, and Colorbars.
- 3) Input:** Rename the inputs or modify the HDCP behavior (HDMI inputs only) by clicking on the Edit icon (✎) to open the editing window. Click on “Save” to confirm and activate any changes made to a name. Changes made to the HDCP behavior are applied immediately.
- **Apple Mode:** Completely disables HDCP support on the input.
  - **Follow In:** HDCP support follows the HDCP mode required by the connected source device.
  - **Follow Out:** HDCP support follows the HDCP mode supported by the connected sink.

### 6.3.2 Automation Tab

The Automation tab provides control over the unit's automatic control command broadcast behavior when the specified system Automation Events occur. Automation commands may be sent to 3rd party devices via standard CEC, or customizable RS-232.

*Note: Sending RS-232 commands requires the use of a compatible HDBaseT Receiver with an RS-232 port.*

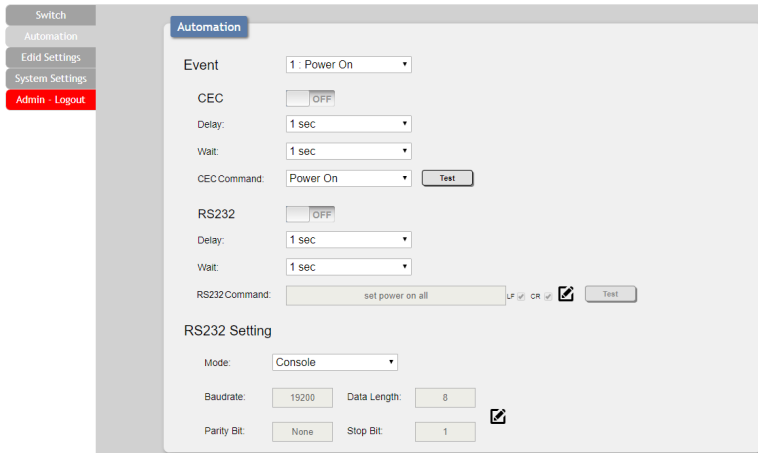

The screenshot shows the 'Automation' tab in a web interface. On the left is a navigation menu with 'Switch', 'Automation', 'Edit Settings', 'System Settings', and 'Admin - Logout'. The main content area is titled 'Automation' and contains the following settings:

- Event:** 1 - Power On
- CEC:** OFF (checkbox), Delay: 1 sec, Wait: 1 sec, CEC Command: Power On (dropdown), Test button.
- RS232:** OFF (checkbox), Delay: 1 sec, Wait: 1 sec, RS232 Command: set power on all (text input), LF, CR, and copy icons, Test button.
- RS232 Setting:** Mode: Console (dropdown), Baudrate: 19200, Data Length: 8, Parity Bit: None, Stop Bit: 1, and a copy icon.

1) **Event:** Use the dropdown to select the Automation Event to configure. Available Automation Events are:

- **Power On:** This unit is powered on.
- **Out A Source Active:** The currently selected input changes from inactive to active.
- **Out A Source Lost:** The currently selected input changes from active to inactive.
- **CEC:** Enable or disable sending a CEC command when the currently selected Automation Event is activated.  
*Note: CEC support must be enabled on the connected HDMI device.*
- **Delay:** Set the length of time, in seconds, that the specified Automation Event must continue to be true before sending the defined CEC command.
- **Wait:** Set the length of time, in seconds, to wait after this CEC

Automation Event has been activated before ANY other Automation Event can be detected.

- **CEC Command:** Set the CEC command to send when the specified Automation Event is activated. Clicking the “Test” button will send the command immediately. Available CEC commands are:
  - **Power Off:** Turn off the connected HDMI display device.
  - **Power On:** Turn on the connected HDMI display device.
  - **Active Source:** Force the connected HDMI display device to switch to the HDMI input that this unit is connected to.

*Note: Not all HDMI devices support all CEC commands.*

- **RS-232:** Enable or disable sending an RS-232 command when the currently selected Automation Event is activated.

*Note: The RS-232 port must be in “Control” mode to send commands to external devices.*

- **Delay:** Set the length of time, in seconds, that the specified Automation Event must continue to be true before sending the defined RS-232 command.
- **Wait:** Set the length of time, in seconds, to wait after this RS-232 Automation Event has been activated before ANY other Automation Event can be detected.
- **RS-232 Command:** Click the Edit icon (✎) to define the RS-232 command to send when the specified Automation Event is activated. Clicking the “Test” button will send the command immediately.

**2) RS-232 Setting:** Provides controls to configure the settings and behavior of the RS-232 port.

- **Mode:** Switch the behavior of the RS-232 port between “Console” and “Control”. When “Console” is selected, the unit can receive and be controlled directly via RS-232 commands. When “Control” is selected the RS-232 port can send Automation commands to control other devices.
- **RS-232 Setting Edit:** Click on the Edit icon (✎) to configure the various RS-232 port settings including baud rate, data length, parity and stop bits.

### 6.3.3 EDID Settings Tab

This tab provides control over the EDID behavior of the unit. There are six internal EDIDs, three customer uploaded EDIDs, and one sink sourced EDID that can be assigned to each input port individually. The sink EDID and Customer EDIDs are also available for download to the connected PC.

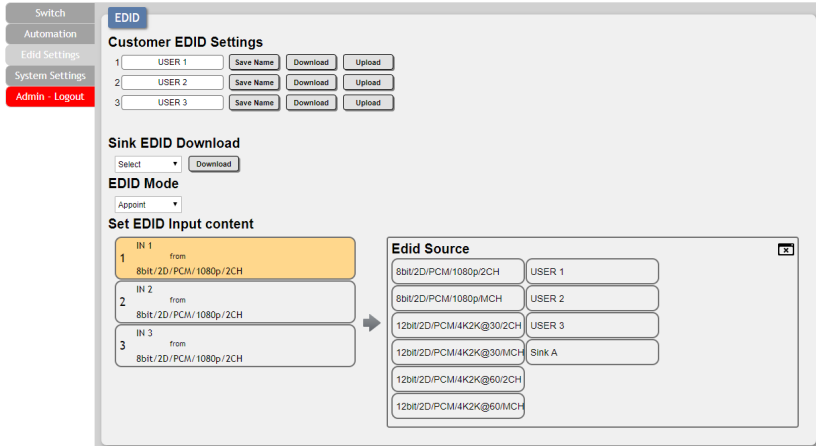

- 1) **Customer EDID Settings:** Manage the uploadable User EDID content.
  - **Save Name:** Type the preferred name for the User EDID in the space provided then click "Save Name" to confirm the change.
  - **Download:** Click to download and save the current User EDID as a file (\*.bin) on the connected PC.
  - **Upload:** Click to upload a previously saved EDID file (\*.bin) from the connected PC into the User EDID slot.
- 2) **Sink EDID Download:** Select and save the EDID from a connected display.
  - **Drop-down Menu:** Select the sink to read an EDID from for download.
  - **Download:** Click to download the EDID from the selected sink as a file (\*.bin) to the connected PC.
- 3) **EDID mode:** This dropdown controls how EDIDs are assigned to the unit's Inputs.

- **All:** Selecting this will allow the assignment of a single EDID to all Inputs simultaneously.
  - **Appoint:** Selecting this allows for a different EDID to be assigned to each Input.
- 4) **Set EDID Input Content:** This section provides a way to set the EDID to use with the selected Input.
- **IN 1/IN 2/IN 3/All Input:** Click the appropriate buttons to select the preferred Input(s) and open the EDID Source table for assigning an EDID.
  - **EDID Source:** Click the EDID to assign to the selected Input. Once the EDID has been selected, the change will occur immediately.

The EDIDs available in the EDID Source table are:

EDID Source	EDID Content
8bit/2D/PCM/1080p/2CH	1080p@60Hz, LPCM 2.0
8bit/2D/PCM/1080p/MCH	1080p@60Hz, LPCM 7.1+Bitstream
12bit/2D/PCM/4K2K@30/2CH	4K@30Hz, LPCM 2.0
12bit/2D/PCM/4K2K@30/MCH	4K@30Hz, LPCM 7.1+Bitstream
12bit/2D/PCM/4K2K@60/2CH	4K@60Hz, LPCM 2.0
12bit/2D/PCM/4K2K@60/MCH	4K@60Hz, LPCM 7.1+Bitstream
USER 1	The first Customer EDID
USER 2	The second Customer EDID
USER 3	The third Customer EDID
SINK A	EDID copied from Output A

### 6.3.4 Systems Settings Tab

This tab provides access to control a number of system configuration controls including displaying the unit's serial number, modifying the web access privileges, changing the IP configuration, performing a factory reset, rebooting the system, and updating the firmware.

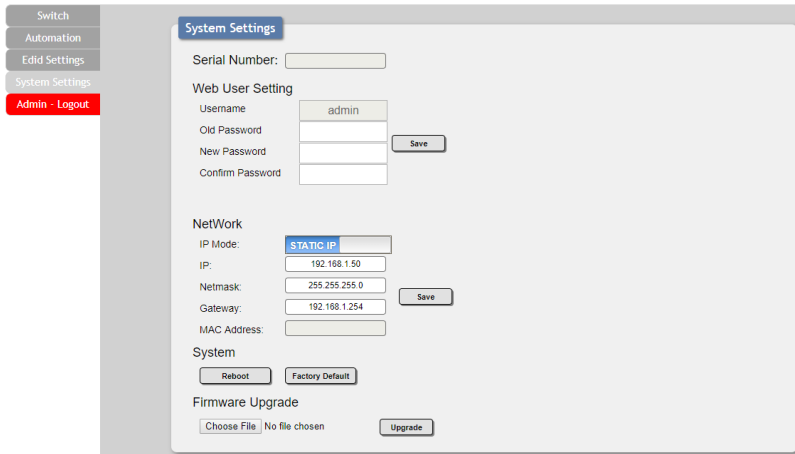

- 1) **Serial Number:** Displays the unit's serial number.
- 2) **Web User Setting:** This section provides a way to change the password for the Administrator account. Click on "Save" to confirm and activate any changes made to these settings.  
*Note: The default password is "admin".*
- 3) **Network:** The IP Address, Netmask and Gateway can be set manually, or DHCP can be enabled for automatic IP Configuration if your local network supports it. Click on "Save" to confirm and activate any changes made to these settings.  
*Note: If the IP address is changed then the IP address required for WebGUI and Telnet access will also change accordingly.*
- 4) **System**
  - **Reboot:** Click this button to reboot the unit.
  - **Factory Default:** Click this button to reset the unit to the factory default settings.
- 5) **Firmware Upgrade:** To update the unit's firmware, click the "Choose File" button to open the file selection window and then select



the firmware update file (\*.bin format) located on your local PC. After selecting the file, click the "Upgrade" button to begin the firmware update process. Once the process completes the unit will automatically reboot.

## 6.4 Serial Control (Via Receiver)

Serial Port Default Settings	
<b>Baud Rate</b>	19200
<b>Data Bits</b>	8
<b>Parity Bits</b>	None
<b>Stop Bits</b>	1
<b>Flow Control</b>	None

*Note: RS-232 support requires the use of a compatible HDBaseT Receiver with an RS-232 bypass port.*

## 6.5 Telnet Control

Before attempting to use Telnet control, please ensure that both the unit and the PC are connected to the same active networks.

To Access the Command Line Interface (CLI)	
Windows 7	Click <b>Start</b> , type "cmd" in the search field, and press <b>Enter</b> .
Windows XP	Click <b>Start &gt; Run</b> , type "cmd", and press <b>Enter</b> .
Mac OS X	Click <b>Go &gt; Applications &gt; Utilities &gt; Terminal</b> .

Once in the Command Line Interface (CLI) type "**telnet**" followed by the IP address of the unit (and the port number if it is non-standard) and then hit "Enter". This will connect us to the unit we wish to control.

```
Microsoft Windows [Version 6.1.7601]
Copyright (c) 2009 Microsoft Corporation. All rights reserved.
C:\Users\Administrator>telnet 192.168.1.50 23
```

*Note 1: If the IP address is changed then the IP address required for Telnet access will also change accordingly.*

*Note 2: The default IP address is 192.168.1.50.*

## 6.6 RS-232 and Telnet Commands

COMMAND	
Description and Parameters	
<b>help</b> ↵	Show all available commands.
<b>?</b> ↵	Show all available commands.
<b>get fw ver</b> ↵	Show the unit's firmware version.
<b>get model name</b> ↵	Show the unit's model name.
<b>get model type</b> ↵	Show the unit's product type.
<b>set factory default</b> ↵	Reset the unit to its factory defaults.
<b>set factory ipconfig default</b> ↵	Reset the unit's IP configuration to the factory defaults.
<b>set system reboot</b> ↵	Reboot the unit.
<b>get mac 1 addr</b> ↵	Show the unit's MAC address.
<b>set ip mode N1</b> ↵	Set the IP address assignment mode. Available values for <b>N1</b> : STATIC [Static IP mode] DHCP [DHCP mode]
<b>get ip mode</b> ↵	Show the current IP mode.

COMMAND	
Description and Parameters	
<b>get ipconfig</b> ↵	
	Show the current IP address details.
<b>set ipaddr N1</b> ↵	
	Set the static IP Address.
<b>N1 = X.X.X.X</b>	[X = 0 ~ 255]
<b>get ipaddr</b> ↵	
	Show the current IP address.
<b>set netmask N1</b> ↵	
	Set the netmask address.
<b>N1 = X.X.X.X</b>	[X = 0 ~ 255]
<b>get netmask</b> ↵	
	Show the current netmask.
<b>set gateway N1</b> ↵	
	Set the gateway address.
<b>N1 = X.X.X.X</b>	[X = 0 ~ 255]
<b>get gateway</b> ↵	
	Show the current gateway.
<b>set in N1 name N2</b> ↵	
	Set the name of input <b>N1</b> .
<b>N1 = 1 ~ 3</b>	[Input number]
<b>N2 = {Name}</b>	[16 characters max]
<b>get in N1 name</b> ↵	
	Show input <b>N1</b> 's current name.
<b>N1 = 1 ~ 3</b>	[Input number]
<b>set out A name N1</b> ↵	
	Set the name of the output.
<b>N1 = {Name}</b>	[16 characters max]

COMMAND	
Description and Parameters	
<b>get out A name</b> ↵	
	Show the output's current name.
<b>set out A route N1</b> ↵	
	Switch the output routing source to input <b>N1</b> .
<b>N1 = 1 ~ 3</b>	[Input number]
<b>get out A route</b> ↵	
	Show the output's current routing source.
<b>get in type list</b> ↵	
	Show each input's video type.
<b>get out type list</b> ↵	
	Show the video type of the output.
<b>set out A mask N1</b> ↵	
	Enable or disable the mask setting on output <b>N1</b> .
	Available values for <b>N1</b> :
OFF	[Mask disabled]
ON	[Mask enabled]
	<i>Note: When an output is masked, all video, including the banner, will be blanked out.</i>
<b>get out A mask</b> ↵	
	Display the current output mask setting.
<b>set out auto mode N1</b> ↵	
	Enable or disable automatic source switching.
	Available values for <b>N1</b> :
0	[Auto switch disabled]
1	[Auto switch enabled]
<b>get out auto mode</b> ↵	
	Show the current auto switch mode state.

COMMAND	
Description and Parameters	
<b>get in port number</b> ↵	
Show the number of inputs on the unit.	
<b>get out port number</b> ↵	
Show the number of outputs on the unit.	
<b>get in N1 sync status</b> ↵	
Show the current sync status of input <b>N1</b> .	
<b>N1</b> = 1 ~ 3	[Input number]
Available Responses:	
0	[No sync]
1	[Sync is present]
<b>get out A sync status</b> ↵	
Show the current sync status of the output.	
Available Responses:	
0	[No sync]
1	[Sync is active]
<b>set all in edid mode N1</b> ↵	
Enable or disable using the same EDID for all inputs.	
Available values for <b>N1</b> :	
ON	[All mode]
OFF	[Appoint mode]
<b>get all in edid mode</b> ↵	
Show the current state of the EDID assignment mode.	

COMMAND	
Description and Parameters	
<b>set all in edid N1 ↵</b>	
Set the EDID to use when set to "All mode".	
Available values for <b>N1</b> :	
1	[8-bit/1080p/2CH LPCM]
2	[8-bit/1080p/MCH]
3	[12-bit/4K@30/2CH LPCM]
4	[12-bit/4K@30/MCH]
5	[12-bit/4K@60/2CH LPCM]
6	[12-bit/4K@60/MCH]
7	[User 1]
8	[User 2]
9	[User 3]
10	[Sink A]
<b>get all in edid ↵</b>	
Show the current "All mode" EDID.	
<b>set in N1 edid N2 ↵</b>	
Assign EDID <b>N2</b> to input <b>N1</b> in "Appoint mode".	
<b>N1</b> = 1 ~ 3	[Input number]
Available values for <b>N1</b> :	
1	[8-bit/1080p/2CH LPCM]
2	[8-bit/1080p/MCH]
3	[12-bit/4K@30/2CH LPCM]
4	[12-bit/4K@30/MCH]
5	[12-bit/4K@60/2CH LPCM]
6	[12-bit/4K@60/MCH]
7	[User 1]
8	[User 2]
9	[User 3]
10	[Sink A]

COMMAND	
Description and Parameters	
<b>get in N1 edid↵</b>	
Show the EDID currently assigned to input <b>N1</b> .	
<b>N1</b> = 1 ~ 3	[Input number]
<b>get in edid list↵</b>	
List all available EDID sources.	
<b>set edid N1 name N2↵</b>	
Set the name of User EDID <b>N1</b> to <b>N2</b> .	
<b>N1</b> = 7 ~ 9	[EDID number]
<b>N2</b> = {Name}	[16 characters max]
<i>Note: Only User EDIDs can be renamed.</i>	
<b>get edid N1 name↵</b>	
Show the current name of user EDID <b>N1</b> .	
<b>N1</b> = 7 ~ 9	[EDID number]
<b>set in N1 hdcp mode N2↵</b>	
Set the HDCP mode to use with the HDMI input <b>N1</b> .	
<b>N1</b> = 2 ~ 3	[HDMI input number]
Available values for <b>N2</b> :	
0	[HDCP disabled]
1	[Follow source]
2	[Follow display]
<b>get in N1 hdcp mode↵</b>	
Show the current HDCP mode of the specified input.	
<b>N1</b> = 2 ~ 3	[HDMI input number]

COMMAND	
Description and Parameters	
<b>set audio out A route N1</b> ↵	
Set the audio source to use with the HDMI inputs.	
Available values for <b>N1</b> :	
1	[HDMI audio]
2	[Analog audio]
<b>get audio out A route</b> ↵	
Show the current HDMI audio source.	
<b>set freerun A mode N1</b> ↵	
Enable or disable the freerun feature when there is no detected input.	
Available values for <b>N1</b> :	
ON	[Freerun enabled]
OFF	[Freerun disabled]
<b>get freerun A mode</b> ↵	
Show the current state of the freerun function.	
<b>set freerun A type N1</b> ↵	
Set the color to display when freerun is enabled and active.	
Available values for <b>N1</b> :	
1	[Black]
3	[Red]
5	[Blue]
10	[Color bar]
<b>set freerun A type</b> ↵	
Show the current freerun display color.	
<b>get freerun list</b> ↵	
List all available freerun colors.	
<b>get automation event list</b> ↵	
List all Automation Event types.	

## COMMAND

### Description and Parameters

#### set automation event N1 uart N2↵

Enable or disable the specified Automation Event's RS-232 response.

Available values for **N1**:

1	[Power on]
2	[Out A source active]
3	[Out A source lost]

Available values for **N2**:

ON	[Event enabled]
OFF	[Event disabled]

#### get automation event N1 uart↵

Show the current state of the specified Automation Event's RS-232 response.

Available values for **N1**:

1	[Power on]
2	[Out A source active]
3	[Out A source lost]

#### set automation event N1 uart delay N2 sec↵

Set the delay time that the specified Automation Event must continue to be true before sending the defined RS-232 command.

Available values for **N1**:

1	[Power on]
2	[Out A source active]
3	[Out A source lost]

**N2** = 1 ~ 300 [Delay in seconds]

## COMMAND

### Description and Parameters

#### **get automation event N1 uart delay**↵

Show the delay time for the specified Automation Event's RS-232 response.

Available values for **N1**:

1	[Power on]
2	[Out A source active]
3	[Out A source lost]

#### **set automation event N1 uart wait N2 sec**↵

Set the length of time to wait after an Automation Event's RS-232 response has been activated before ANY other Automation Event can be detected.

Available values for **N1**:

1	[Power on]
2	[Out A source active]
3	[Out A source lost]

**N2** = 1 ~ 300 [Wait time in seconds]

*Note: If both an RS-232 and CEC event is activated by the same Automation Event, the longer of the 2 wait times will be used.*

#### **get automation event N1 uart wait**↵

Show the wait time for the specified Automation Event's RS-232 response.

Available values for **N1**:

1	[Power on]
2	[Out A source active]
3	[Out A source lost]

## COMMAND

### Description and Parameters

#### set automation event N1 uart command N2↵

Set the RS-232 command string to send when the specified Automation Event is activated.

Available values for **N1**:

- |   |                       |
|---|-----------------------|
| 1 | [Power on]            |
| 2 | [Out A source active] |
| 3 | [Out A source lost]   |

**N2** = {Command} [Max 32 characters]

#### get automation event N1 uart command↵

Show the RS-232 command string to be sent when the specified Automation Event is activated.

Available values for **N1**:

- |   |                       |
|---|-----------------------|
| 1 | [Power on]            |
| 2 | [Out A source active] |
| 3 | [Out A source lost]   |

#### set automation event N1 cec N2↵

Enable or disable the specified Automation Event's CEC response.

Available values for **N1**:

- |   |                       |
|---|-----------------------|
| 1 | [Power on]            |
| 2 | [Out A source active] |
| 3 | [Out A source lost]   |

Available values for **N2**:

- |     |                  |
|-----|------------------|
| ON  | [Event enabled]  |
| OFF | [Event disabled] |

COMMAND							
Description and Parameters							
<b>get automation event N1 cec↵</b>							
<p>Show the current state of the specified Automation Event's CEC response.</p> <p>Available values for <b>N1</b>:</p> <table border="0"> <tr> <td>1</td> <td>[Power on]</td> </tr> <tr> <td>2</td> <td>[Out A source active]</td> </tr> <tr> <td>3</td> <td>[Out A source lost]</td> </tr> </table>		1	[Power on]	2	[Out A source active]	3	[Out A source lost]
1	[Power on]						
2	[Out A source active]						
3	[Out A source lost]						
<b>set automation event N1 cec delay N2 sec↵</b>							
<p>Set the delay time that the specified Automation Event must continue to be true before sending the defined CEC command.</p> <p>Available values for <b>N1</b>:</p> <table border="0"> <tr> <td>1</td> <td>[Power on]</td> </tr> <tr> <td>2</td> <td>[Out A source active]</td> </tr> <tr> <td>3</td> <td>[Out A source lost]</td> </tr> </table> <p><b>N2</b> = 1 ~ 300 [Delay in seconds]</p>		1	[Power on]	2	[Out A source active]	3	[Out A source lost]
1	[Power on]						
2	[Out A source active]						
3	[Out A source lost]						
<b>get automation event N1 cec delay↵</b>							
<p>Show the delay time for the specified Automation Event's CEC response.</p> <p>Available values for <b>N1</b>:</p> <table border="0"> <tr> <td>1</td> <td>[Power on]</td> </tr> <tr> <td>2</td> <td>[Out A source active]</td> </tr> <tr> <td>3</td> <td>[Out A source lost]</td> </tr> </table>		1	[Power on]	2	[Out A source active]	3	[Out A source lost]
1	[Power on]						
2	[Out A source active]						
3	[Out A source lost]						

## COMMAND

### Description and Parameters

#### set automation event N1 cec wait N2 sec↵

Set the length of time to wait after an Automation Event's CEC response has been activated before ANY other Automation Event can be detected.

Available values for **N1**:

- |   |                       |
|---|-----------------------|
| 1 | [Power on]            |
| 2 | [Out A source active] |
| 3 | [Out A source lost]   |

**N2** = 1 ~ 300 [Wait time in seconds]

*Note: If both an RS-232 and CEC event is activated by the same Automation Event, the longer of the 2 wait times will be used.*

#### get automation event N1 cec wait↵

Show the wait time for the specified Automation Event's CEC response.

Available values for **N1**:

- |   |                       |
|---|-----------------------|
| 1 | [Power on]            |
| 2 | [Out A source active] |
| 3 | [Out A source lost]   |

#### set automation event N1 cec command N2↵

Set the CEC command to send when the specified Automation Event is activated.

Available values for **N1**:

- |   |                       |
|---|-----------------------|
| 1 | [Power on]            |
| 2 | [Out A source active] |
| 3 | [Out A source lost]   |

Available values for **N2**:

- |   |                     |
|---|---------------------|
| 1 | [CEC power off]     |
| 2 | [CEC power on]      |
| 3 | [CEC active source] |

COMMAND																	
Description and Parameters																	
<b>get automation event N1 cec command</b> ↵																	
<p>Show the CEC command to be sent when the specified Automation Event is activated.</p> <p>Available values for <b>N1</b>:</p> <table border="0"> <tr> <td>1</td> <td>[Power on]</td> </tr> <tr> <td>2</td> <td>[Out A source active]</td> </tr> <tr> <td>3</td> <td>[Out A source lost]</td> </tr> </table>		1	[Power on]	2	[Out A source active]	3	[Out A source lost]										
1	[Power on]																
2	[Out A source active]																
3	[Out A source lost]																
<b>set uart 1 mode N1</b> ↵																	
<p>Set the RS-232 operation mode of the unit.</p> <p>Available values for <b>N1</b>:</p> <table border="0"> <tr> <td>1</td> <td>[Console Commands]</td> </tr> <tr> <td>2</td> <td>[Control]</td> </tr> </table>		1	[Console Commands]	2	[Control]												
1	[Console Commands]																
2	[Control]																
<b>get uart 1 mode</b> ↵																	
<p>Show the current RS-232 operation mode.</p>																	
<b>set uart 1 baudrate N1</b> ↵																	
<p>Set the RS-232 baud rate.</p> <p>Available values for <b>N1</b>:</p> <table border="0"> <tr> <td>4800</td> <td>[Baud rate]</td> </tr> <tr> <td>7200</td> <td>[Baud rate]</td> </tr> <tr> <td>9600</td> <td>[Baud rate]</td> </tr> <tr> <td>14400</td> <td>[Baud rate]</td> </tr> <tr> <td>19200</td> <td>[Baud rate]</td> </tr> <tr> <td>38400</td> <td>[Baud rate]</td> </tr> <tr> <td>57600</td> <td>[Baud rate]</td> </tr> <tr> <td>115200</td> <td>[Baud rate]</td> </tr> </table>		4800	[Baud rate]	7200	[Baud rate]	9600	[Baud rate]	14400	[Baud rate]	19200	[Baud rate]	38400	[Baud rate]	57600	[Baud rate]	115200	[Baud rate]
4800	[Baud rate]																
7200	[Baud rate]																
9600	[Baud rate]																
14400	[Baud rate]																
19200	[Baud rate]																
38400	[Baud rate]																
57600	[Baud rate]																
115200	[Baud rate]																
<b>get uart 1 baudrate</b> ↵																	
<p>Show the current RS-232 baud rate.</p>																	

COMMAND	
Description and Parameters	
<b>set uart 1 stop bit N1↵</b>	
Set the number of RS-232 stop bits to use.	
<b>N1 = 1 ~ 2</b>	[Stop bits]
<b>get uart 1 stop bit↵</b>	
Show the current RS-232 stop bits setting.	
<b>set uart 1 data bit N1↵</b>	
Set the number of RS-232 data bits to use.	
<b>N1 = 5 ~ 8</b>	[Data bits]
<b>get uart 1 data bit↵</b>	
Show the current RS-232 data bits setting.	
<b>set uart 1 parity N1↵</b>	
Set the parity value for RS-232.	
Available values for <b>N1</b> :	
0	[None]
1	[Odd]
2	[Even]
<b>get uart 1 parity↵</b>	
Show the current RS-232 parity setting.	

*Note: Commands will not be executed unless followed by a carriage return. Commands are not case-sensitive.*

## 7. CONNECTION DIAGRAM

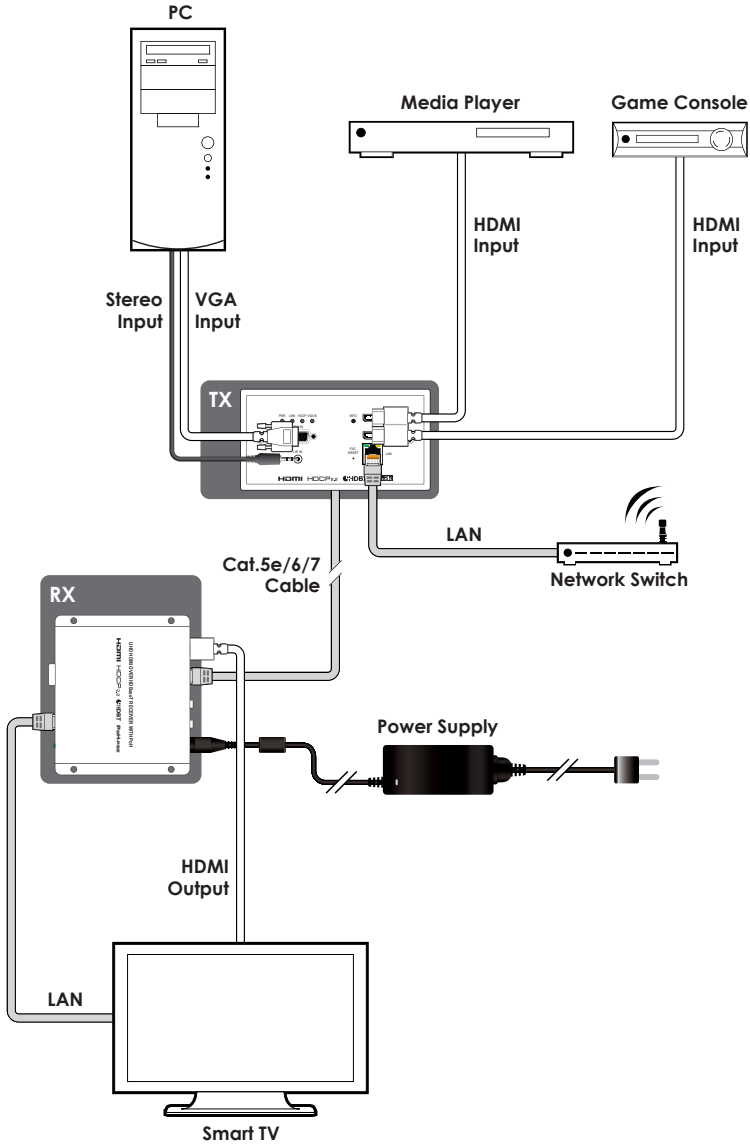

## 8. SPECIFICATIONS

### 8.1 Basic Specifications

<b>HDMI Bandwidth</b>	600MHz/18Gbps
<b>HDBaseT Bandwidth</b>	340MHz/10.2Gbps
<b>Input Ports</b>	2×HDMI 1×VGA (HD-15) 1×Analog Stereo (3.5mm)
<b>Output Port</b>	1×HDBaseT (RJ-45)
<b>Pass-through/Control Port</b>	1×LAN (RJ-45)
<b>Service Port</b>	1×USB (Type-A)
<b>Baud Rate</b>	Up to 115200
<b>Power Supply</b>	48V PoH or 12V/3A DC (US/EU standards, CE/FCC/UL certified)
<b>ESD Protection</b>	Human Body Model ±8kV (Air Discharge), ±4kV (Contact Discharge)
<b>Dimensions</b>	152mm×81mm×42mm (W×H×D) [Case Only] 152mm×81mm×53mm (W×H×D) [All Inclusive]
<b>Weight</b>	250g
<b>Chassis Material</b>	Metal (Steel)
<b>Chassis Color</b>	White
<b>Operating Temperature</b>	0°C – 40°C/32°F – 104°F
<b>Storage Temperature</b>	-20°C – 60°C/-4°F – 140°F
<b>Relative Humidity</b>	20 – 90% RH (Non-condensing)
<b>Power Consumption</b>	22.9W



## 8.2 Video Specifications

Supported Resolutions (Hz)	Input		Output
	HDMI	VGA	HDBaseT
720×400p@70/85	✓	✓	✓
640×480p@60/72/75/85	✓	✓	✓
720×480i@60	✓	✓	✓
720×480p@60	✓	✓	✓
720×576i@50	✓	✓	✓
720×576p@50	✓	✓	✓
800×600p@56/60/72/75/85	✓	✓	✓
848×480p@60	✓	✓	✓
1024×768p@60/70/75/85	✓	✓	✓
1152×864p@75	✓	✓	✓
1280×720p@50/60	✓	✓	✓
1280×768p@60RB/60/75/85	✓	✓	✓
1280×800p@60RB/60/75/85	✓	✓	✓
1280×960p@60/85	✓	✓	✓
1280×1024p@60/75/85	✓	✓	✓
1360×768p@60	✓	✓	✓
1366×768p@60RB/60	✓	✓	✓
1400×1050p@60RB/60	✓	✓	✓
1440×900p@60RB/60/75	✓	✓	✓
1600×900p@60RB	✓	✓	✓
1600×1200p@60	✓	✓	✓
1680×1050p@60RB/60	✓	✓	✓
1920×1080i@50/60	✓	✓	✓
1920×1080p@24/25/30	✓	✓	✓
1920×1080p@50/60	✓	✓	✓

Supported Resolutions (Hz)	Input		Output
	HDMI	VGA	HDBaseT
1920×1200p@60RB	✓	✓	✓
2560×1440p@60RB	✓	×	✓
2560×1600p@60RB	✓	×	✓
2048×1080p@24/25/30	✓	×	✓
2048×1080p@50/60	✓	×	✓
3840×2160p@24/25/30	✓	×	✓
3840×2160p@50/60 (4:2:0)	✓	×	✓
3840×2160p@24/25/30, HDR10	✓	×	×
3840×2160p@50/60 (4:2:0), HDR10	✓	×	×
3840×2160p@50/60	✓	×	×
4096×2160p@24/25/30	✓	×	✓
4096×2160p@50/60 (4:2:0)	✓	×	✓
4096×2160p@24/25/30, HDR10	✓	×	×
4096×2160p@50/60 (4:2:0), HDR10	✓	×	×
4096×2160p@50/60	✓	×	×



## 8.3 Audio Specifications

### 8.3.1 Digital Audio

HDMI Input	
LPCM	
Max Channels	8 Channels
Sampling Rate (kHz)	32, 44.1, 48, 88.2, 96, 176.4, 192
Bitstream	
Supported Formats	Standard & High-Definition

### 8.3.2 Analog Audio

Analog Input	
Max Audio Level	2Vrms
Impedance	10k $\Omega$
Type	Unbalanced

## 8.4 Cable Specifications

Cable Length	1080p		4K30	4K60
	8-bit	12-bit	(4:4:4) 8-bit	(4:4:4) 8-bit
<b>High Speed HDMI Cable</b>				
<b>HDMI Input</b>	15m	10m	5m	3m
<b>Ethernet Cable</b>				
<b>Cat.5e/6</b>	100m		70m	x
<b>Cat.6a/7</b>	100m		100m	x

- **1080p (FHD Video)**
  - Up to 1080p@60Hz, 12-bit color
  - Data rates lower than 5.3Gbps or below 225MHz TMDS clock
- **4K30 (UHD Video)**
  - 4K@24/25/30Hz & 4K@50/60Hz (4:2:0), 8-bit color
  - Data rates higher than 5.3Gbps or above 225MHz TMDS clock but below 10.2Gbps
- **4K60 (UHD+ Video)**
  - 4K@50/60Hz (4:4:4, 8-bit)
  - 4K@50/60Hz (4:2:0, 10-bit HDR)
  - Data rates higher than 10.2Gbps

## 8.5 HDBaseT Features

HDBaseT Feature Set	
<b>Video &amp; Audio</b>	Supported
<b>IR Pass-through</b>	Unsupported
<b>RS-232 Pass-through</b>	Unsupported
<b>Accept power from Receiver</b>	Supported
<b>Send power to Receiver</b>	Unsupported
<b>LAN Pass-through</b>	Supported

## 9. ACRONYMS

ACRONYM	COMPLETE TERM
<b>AV</b>	Audio/Video
<b>Cat.5e</b>	Enhanced Category 5 cable
<b>Cat.6</b>	Category 6 cable
<b>Cat.6a</b>	Augmented Category 6 cable
<b>Cat.7</b>	Category 7 cable
<b>CEC</b>	Consumer Electronics Control
<b>CLI</b>	Command-Line Interface
<b>DHCP</b>	Dynamic Host Configuration Protocol
<b>DVI</b>	Digital Visual Interface
<b>EDID</b>	Extended Display Identification Data
<b>GUI</b>	Graphical User Interface
<b>HD</b>	High-Definition
<b>HDBT</b>	HDBaseT
<b>HDCP</b>	High-bandwidth Digital Content Protection
<b>HDMI</b>	High-Definition Multimedia Interface
<b>HDR</b>	High Dynamic Range
<b>HDTV</b>	High-Definition Television
<b>IP</b>	Internet Protocol
<b>LAN</b>	Local Area Network
<b>LED</b>	Light-Emitting Diode
<b>LPCM</b>	Linear Pulse-Code Modulation
<b>OSD</b>	On-Screen Display
<b>PC</b>	Personal Computer
<b>PD</b>	Powered Device
<b>PoH</b>	Power over HDBaseT
<b>PSE</b>	Power Sourcing Equipment
<b>TCP</b>	Transmission Control Protocol

ACRONYM	COMPLETE TERM
<b>UHD</b>	Ultra-High-Definition
<b>UHD+</b>	Ultra-High-Definition Plus
<b>UHDTV</b>	Ultra-High-Definition Television
<b>USB</b>	Universal Serial Bus
<b>VGA</b>	Video Graphics Array
<b>WUXGA (RB)</b>	Widescreen Ultra Extended Graphics Array (Reduced Blanking)
<b>XGA</b>	Extended Graphics Array



**CYPRESS TECHNOLOGY CO., LTD.**

[www.cypress.com.tw](http://www.cypress.com.tw)