

CHANNEL	VALUE	FUNCTION
	151 ↔ 160	1200Hz
	161 ↔ 170	2400Hz
	171 ↔ 180	4000Hz
	181 ↔ 190	6000Hz
	191 ↔ 200	25000Hz
	201 ↔ 210	ALL RESET
	211 ↔ 220	XY RESET
	221 ↔ 230	COLOR SYSTEM RESET
	231 ↔ 240	GOBO RESET
	241 ↔ 250	FOCUS\ZOOM
	251 ↔ 255	NO FUNCTION

PLUTO 250

USER MANUAL

 [®] PLUTO 250
SS662

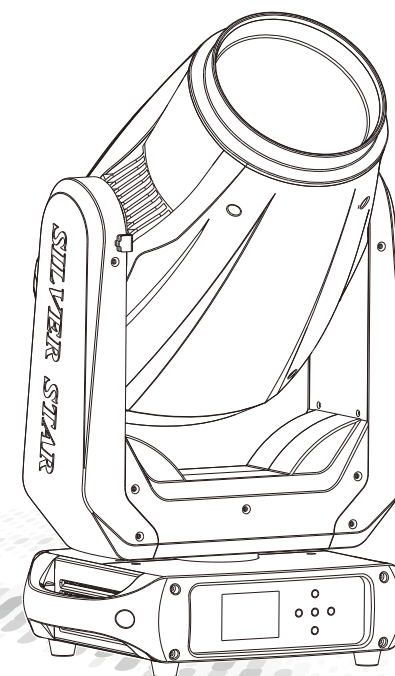

MODEL:SS662SC



广州市雅江光电设备有限公司

Guangzhou Yajiang Photoelectric Equipment Ltd.

电话/Tel : 020-86947788 邮箱/E-mail : sales@yajiang.cn

传真/Fax : 020-86943773 网址/Website : www.yajiang.cn

— Since 1985 —

RD-SS662-SM-01(SS-I)

1 Product Introduction

1.1 Specification

Product Code	SS662SC
Dimension	358 × 250 × 609(mm)
Weight	19KG
Rated Power	350W
Input Voltage	AC100~240V
Frequency Range	50/60Hz
Ambient Temperature	-20°C~45°C
Beam Angle	3°~30°
Control Model	DMX512/RDM/Art-Net

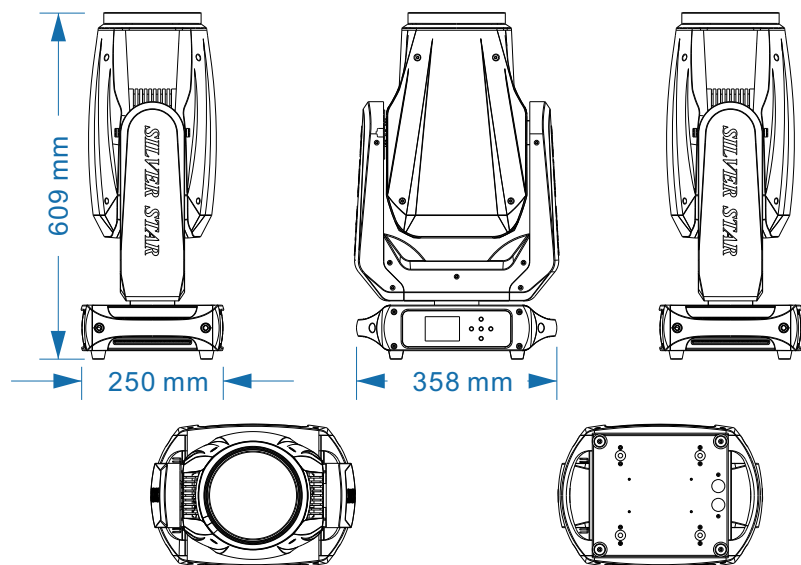

CHANNEL	VALUE	FUNCTION
CH.10	000↔10	WHITE
	011↔255	FROST→100%
CH.11	000↔255	ZOOM
AUTO FOCUS		
CH.12	0 ↔ 12	NO FUNCTION
	13 ↔ 39	5M
	40 ↔ 66	7M
	67 ↔ 93	9M
	94 ↔ 120	11M
	121↔147	13M
	148↔174	15M
	175↔201	17M
	202↔228	19M
229↔255	21M	
CH.13	0 ↔ 255	MANUAL FOCUS
CH.14	0 ↔ 255	DIMMER
STORBE		
CH.15	0 ↔ 9	NO FUNCTION
	10 ↔ 99	STROBE FROM (SLOW TO FAST ,0-25Hz)
	100↔109	NO FUNCTION
	110↔179	LIGHTNING STROBE
	180↔189	NO FUNCTION
	190↔255	RANDOM STROBE
CONTROL		
CH.16	000↔010	NO FUNCTION
	011↔020	PAN/TILT BLACK ACTIVATED
	021↔030	PAN/TILT BLACK DEACTIVATED
	031↔040	PAN INVERT
	041↔050	TILT INVERT
	051↔060	PAN/TILT INVERT OFF
	061↔070	FAN SLOW
	071↔080	FAN NORMAL
	081↔090	FAN FAST
	091↔100	FAN AUTO
	101↔110	DIM4
	111↔120	DIM3
	121↔130	DIM2
	131↔140	DIM1
	141↔150	DIM OFF

CHANNEL	VALUE	FUNCTION
	193 ↔ 255	STATIC GOBO FLOWING WATER EFFECT (SPEED 1 → 100%)
	ROTATING GOBO 8+1	
	000 ↔ 010	WHITE
	011 ↔ 016	GOBO1
	017 ↔ 022	GOBO2
	023 ↔ 028	GOBO3
	029 ↔ 034	GOBO4
	035 ↔ 040	GOBO5
	041 ↔ 046	GOBO6
	047 ↔ 052	GOBO7
	053 ↔ 058	GOBO8
CH.7	059 ↔ 066	GOBO1 SHAKE (SPEED 1 → 100%)
	067 ↔ 074	GOBO2 SHAKE (SPEED 1 → 100%)
	075 ↔ 082	GOBO3 SHAKE (SPEED 1 → 100%)
	083 ↔ 090	GOBO4 SHAKE (SPEED 1 → 100%)
	091 ↔ 098	GOBO5 SHAKE (SPEED 1 → 100%)
	099 ↔ 106	GOBO6 SHAKE (SPEED 1 → 100%)
	107 ↔ 114	GOBO7 SHAKE (SPEED 1 → 100%)
	115 ↔ 122	GOBO8 SHAKE (SPEED 1 → 100%)
	123 ↔ 127	WHITE
	128 ↔ 190	ROTATING GOBO FLOWING WATER EFFECT (SPEED 100% → 1)
	191 ↔ 192	STOP
	193 ↔ 255	ROTATING GOBO FLOWING WATER EFFECT (SPEED 1 → 100%)
	GOBO ROTATING	
	0 ↔ 120	ROTATING GOBO ANGLE ADJUSTMENT (0 → 360°)
	121 ↔ 125	STOP
	126 ↔ 165	ROTATING GOBO SHAKE (SPEED 1 → 100%)
CH.8	166 ↔ 170	STOP
	171 ↔ 210	ROTATING GOBO POSITIVE ROTATION (SPEED 100% → 1)
	211 ↔ 215	STOP
	216 ↔ 255	ROTATING GOBO REVERSE ROTATION (SPEED 1 → 100%)
	PRISM	
	0 ↔ 10	WHITE
	11 ↔ 145	PRISM 0-360°
CH.9	146 ↔ 150	STOP
	151 ↔ 200	PRISM INSERT AND POSITIVE ROTATION (SPEED 100% → 1)
	201 ↔ 205	STOP
	206 ↔ 255	PRISM INSERT AND REVERSE ROTATION (SPEED 1 → 100%)
	IRIS	

1.2 Safety warning

IMPORTANT

Always read the user manual before operation.

Please confirm that the power supply stated on the product is the same as the mains power supply in your area.

- This product must be installed by a qualified professional.
- Always operate the equipment as described in the user manual.
- A minimum distance of 0.5m must be maintained between the equipment and combustible surface.
- The product must always be placed in a well ventilated area.
- Always make sure that the equipment is installed securely.
- Do not stand close to the equipment and stare directly into the LED light source.
- Always disconnect the power supply before attempting and maintenance.
- Always make sure that the supporting structure is solid and can support the combined weight of the products.
- The earth wire must always be connected to the ground.
- Do not touch the power cables if your hands are wet.

ATTENTION



- This product left the place of manufacture in perfect condition. In order to maintain this condition and for safe operation, the user must always follow the instructions and safety warnings described in this user manual.
- Avoid shaking or strong impacts to any part of the equipment.
- Make sure that all parts of the equipment are kept clean and free of dust.
- Always make sure that the power connections are connected correct and secure.
- If there is any malfunction of the equipment, contact your distributor immediately.
- When transferring the product, it is advisable to use the original packaging in which the product left the factory.
- Shields, lenses or ultraviolet screens shall be changed if they have become damaged to such an extent that their effectiveness is impaired.
- The lamp (LED) shall be changed if it has become damaged or thermally deformed.



Caution, risk of electric shock
The light source contained in this luminaire shall only be replaced by the manufacturer or his service agent or a similar qualified person.

2 Installation

2.1 Mounting

The fixture can be mounted in any position.
Always ensure that mounting surface can withstand 10 times the weight of the fixture.

Always use a safety cable when mounting the fixture in any elevated position.

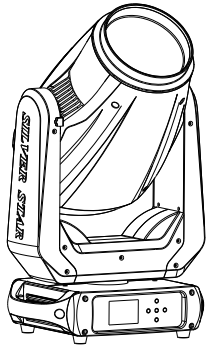

UPRIGHT

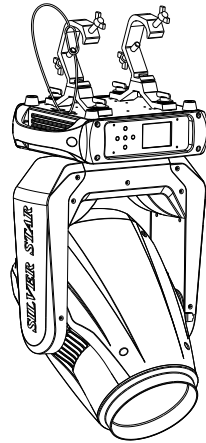

HANGING

Important safety note!!
Always use a safety cable when installing this unit!!
Be sure that the safety cable is connected to a solid load-bearing structure.

2.2 Fuse replacement

- Remove the safety cap by a screwdriver.
- Fetch the old fuse from safety cap.
- Install a new fuse.
- Install the safety cap.

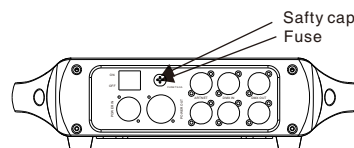

CHANNEL	VALUE	FUNCTION
CH.4	015 ↔ 021	COLOR02
	022 ↔ 028	COLOR03
	029 ↔ 035	COLOR04
	036 ↔ 042	COLOR05
	043 ↔ 049	COLOR06
	050 ↔ 056	COLOR07
	057 ↔ 063	COLOR08
	064 ↔ 191	COLOR WHEEL 0-360°
	192 ↔ 222	COLOR WHEEL RAINBOW EFFECT (SPEED 100% → 1)
	223 ↔ 224	STOP
CH.5	225 ↔ 255	COLOR WHEEL RAINBOW EFFECT (SPEED 1 → 100%)
	000 ↔ 255	COLOR WHEEL FINE ADJUSTMENT. AVAILABLE WHEN THE VALUE IS UNDER 128 ON CHANNELS 10.
STATIC GOBO 11+1		
CH.6	000 ↔ 010	WHITE
	011 ↔ 015	GOBO1
	016 ↔ 020	GOBO2
	021 ↔ 025	GOBO3
	026 ↔ 030	GOBO4
	031 ↔ 035	GOBO5
	036 ↔ 040	GOBO6
	041 ↔ 045	GOBO7
	046 ↔ 050	GOBO8
	051 ↔ 055	GOBO9
	056 ↔ 060	GOBO10
	061 ↔ 065	GOBO11
	066 ↔ 070	GOBO1 SHAKE (SPEED 1 → 100%)
	071 ↔ 075	GOBO2 SHAKE (SPEED 1 → 100%)
	076 ↔ 080	GOBO3 SHAKE (SPEED 1 → 100%)
	081 ↔ 085	GOBO4 SHAKE (SPEED 1 → 100%)
	086 ↔ 090	GOBO5 SHAKE (SPEED 1 → 100%)
	091 ↔ 095	GOBO6 SHAKE (SPEED 1 → 100%)
	096 ↔ 100	GOBO7 SHAKE (SPEED 1 → 100%)
	101 ↔ 105	GOBO8 SHAKE (SPEED 1 → 100%)
106 ↔ 110	GOBO9 SHAKE (SPEED 1 → 100%)	
111 ↔ 115	GOBO10 SHAKE (SPEED 1 → 100%)	
116 ↔ 120	GOBO11 SHAKE (SPEED 1 → 100%)	
121 ↔ 127	WHITE	
128 ↔ 190	STATIC GOBO FLOWING WATER EFFECT (SPEED 100% → 1)	
191 ↔ 192	STOP	

CHANNEL	VALUE	FUNCTION
	180↔189	NO FUNCTION
	190↔255	RANDOM STROBE
CONTROL		
	000↔010	NO FUNCTION
	011↔020	PAN/TILT BLACK ACTIVATED
	021↔030	PAN/TILT BLACK DEACTIVATED
	031↔040	PAN INVERT
	041↔050	TILT INVERT
	051↔060	PAN/TILT INVERT OFF
	061↔070	FAN SLOW
	071↔080	FAN NORMAL
	081↔090	FAN FAST
	091↔100	FAN AUTO
	101↔110	DIM4
	111↔120	DIM3
	121↔130	DIM2
	131↔140	DIM1
	141↔150	DIM OFF
	151↔160	1200Hz
	161↔170	2400Hz
	171↔180	4000Hz
	181↔190	6000Hz
	191↔200	25000Hz
	201↔210	ALL RESET
	211↔220	XY RESET
	221↔230	COLOR SYSTEM RESET
	231↔240	GOBO RESET
	241↔250	FOCUS\ZOOM
	251↔255	NO FUNCTION

CH.19

BASIC		
CHANNEL	VALUE	FUNCTION
CH.1	000↔255	PAN 0-540°
CH.2	000↔255	TILT 0-270°
CH.3	000↔255	PT SPEED
COLOR WHEEL 8+1		
	000↔007	WHITE
	008↔014	COLOR01

2.3 Power connections

This product uses input and output power cable is 1.5 square mm copper wire
Note:

If the signal cable is over 60m between the DMX512 controller and fixture or between two fixtures, then a DMX signal amplifier is needed as well.

This product provides for the use of input power and signal cables are three-core, the connection diagram is as follows

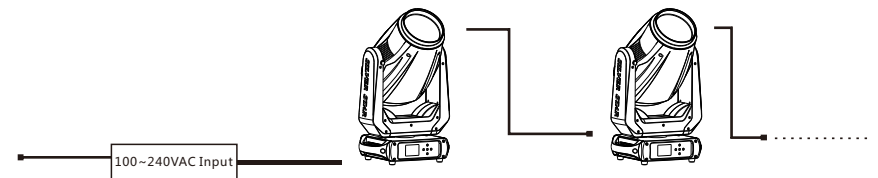

- When using this product to connect 220V AC, the number of tandem fixtures must not exceed eight.
- When using this product to connect 110V AC, the number of tandem fixtures must not exceed four.

3 Display panel operation

3.1 Display operation

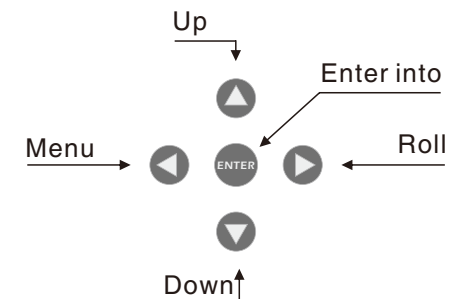

3.2 Menu

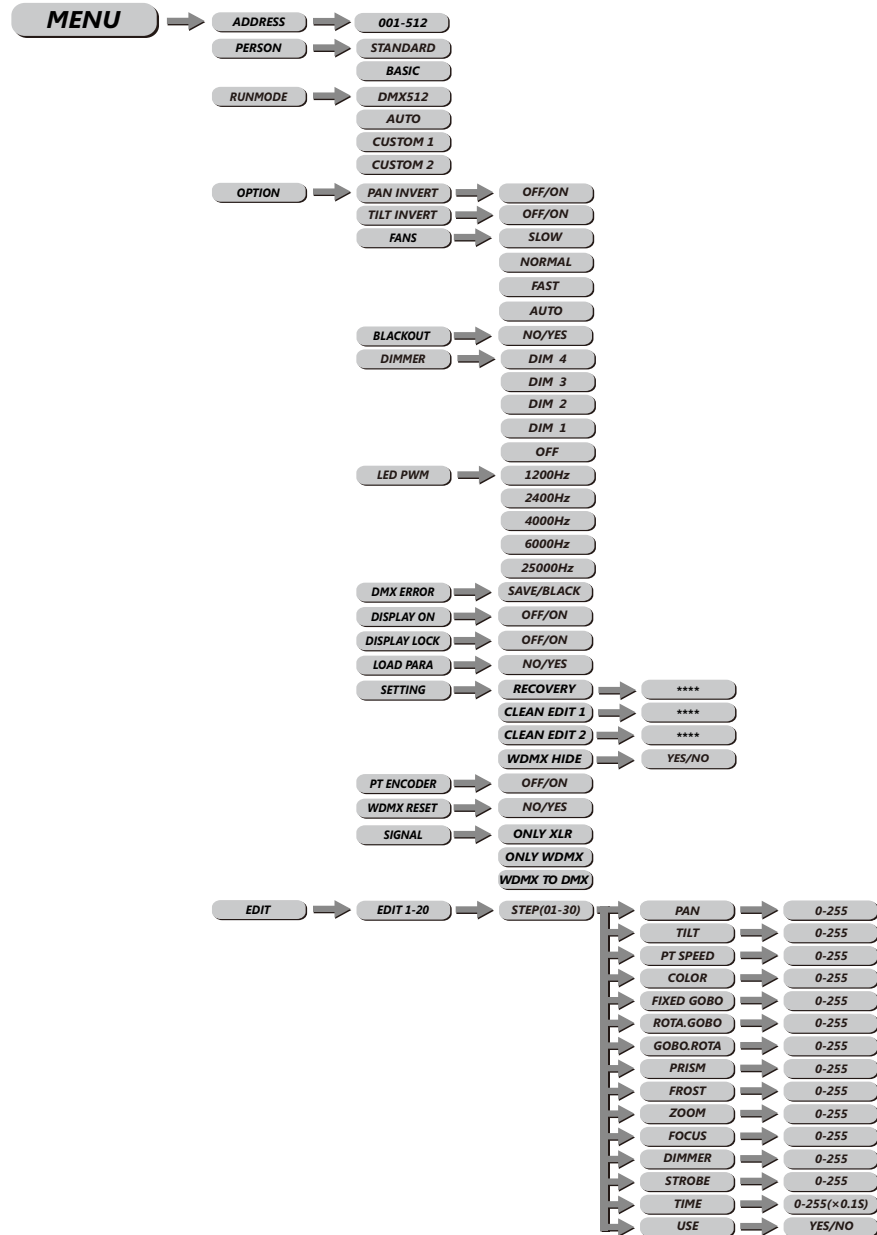

CHANNEL	VALUE	FUNCTION
	193↔255	ROTATING GOBO FLOWING WATER EFFECT (SPEED 1→100%)
	GOBO ROTATING	
	0 ↔ 120	ROTATING GOBO ANGLE ADJUSTMENT (0 → 360°)
	121↔125	STOP
	126↔165	ROTATING GOBO SHAKE (SPEED 1 → 100%)
CH.10	166↔170	STOP
	171↔210	ROTATING GOBO POSITIVE ROTATION (SPEED 100% → 1)
	211↔215	STOP
	216↔255	ROTATING GOBO REVERSE ROTATION (SPEED 1 → 100%)
	PRISM	
	0 ↔ 10	WHITE
	11 ↔ 145	PRISM 0-360°
CH.11	146↔150	STOP
	151↔200	PRISM INSERT AND POSITIVE ROTATION (SPEED 100%→1)
	201↔205	STOP
	206↔255	PRISM INSERT AND REVERSE ROTATION (SPEED 1→100%)
	IRIS	
CH.12	000↔ 10	WHITE
	011↔255	FROST→100%
CH.13	000↔255	ZOOM
	AUTO FOCUS	
	0 ↔ 12	NO FUNCTION
	13 ↔ 39	5M
	40 ↔ 66	7M
	67 ↔ 93	9M
CH.14	94 ↔ 120	11M
	121↔147	13M
	148↔174	15M
	175↔201	17M
	202↔228	19M
	229↔255	21M
CH.15	0 ↔ 255	MANUAL FOCUS
CH.16	0 ↔ 255	DIMMER
CH.17	0 ↔ 255	16B DIMMER FINE
	STORBE	
	0 ↔ 9	NO FUNCTION
	10 ↔ 99	STROBE FROM (SLOW TO FAST ,0-25Hz)
CH.18	100↔109	NO FUNCTION
	110↔179	LIGHTNING STROBE

CHANNEL	VALUE	FUNCTION
CH.8	051 ↔ 055	GOBO9
	056 ↔ 060	GOBO10
	061 ↔ 065	GOBO11
	066 ↔ 070	GOBO1 SHAKE (SPEED 1 → 100%)
	071 ↔ 075	GOBO2 SHAKE (SPEED 1 → 100%)
	076 ↔ 080	GOBO3 SHAKE (SPEED 1 → 100%)
	081 ↔ 085	GOBO4 SHAKE (SPEED 1 → 100%)
	086 ↔ 090	GOBO5 SHAKE (SPEED 1 → 100%)
	091 ↔ 095	GOBO6 SHAKE (SPEED 1 → 100%)
	096 ↔ 100	GOBO7 SHAKE (SPEED 1 → 100%)
	101 ↔ 105	GOBO8 SHAKE (SPEED 1 → 100%)
	106 ↔ 110	GOBO9 SHAKE (SPEED 1 → 100%)
	111 ↔ 115	GOBO10SHAKE (SPEED 1 → 100%)
	116 ↔ 120	GOBO11SHAKE (SPEED 1 → 100%)
	121 ↔ 127	WHITE
	128 ↔ 190	STATIC GOBO FLOWING WATER EFFECT (SPEED 100% → 1)
	191 ↔ 192	STOP
	193 ↔ 255	STATIC GOBO FLOWING WATER EFFECT (SPEED 1 → 100%)
	CH.9	ROTATING GOBO 8+1
000 ↔ 010		WHITE
011 ↔ 016		GOBO1
017 ↔ 022		GOBO2
023 ↔ 028		GOBO3
029 ↔ 034		GOBO4
035 ↔ 040		GOBO5
041 ↔ 046		GOBO6
047 ↔ 052		GOBO7
053 ↔ 058		GOBO8
059 ↔ 066		GOBO1 SHAKE (SPEED 1 → 100%)
067 ↔ 074		GOBO2 SHAKE (SPEED 1 → 100%)
075 ↔ 082		GOBO3 SHAKE (SPEED 1 → 100%)
083 ↔ 090		GOBO4 SHAKE (SPEED 1 → 100%)
091 ↔ 098		GOBO5 SHAKE (SPEED 1 → 100%)
099 ↔ 106		GOBO6 SHAKE (SPEED 1 → 100%)
107 ↔ 114		GOBO7 SHAKE (SPEED 1 → 100%)
115 ↔ 122		GOBO8 SHAKE (SPEED 1 → 100%)
123 ↔ 127		WHITE
128 ↔ 190		ROTATING GOBO FLOWING WATER EFFECT (SPEED 100% → 1)
191 ↔ 192		STOP

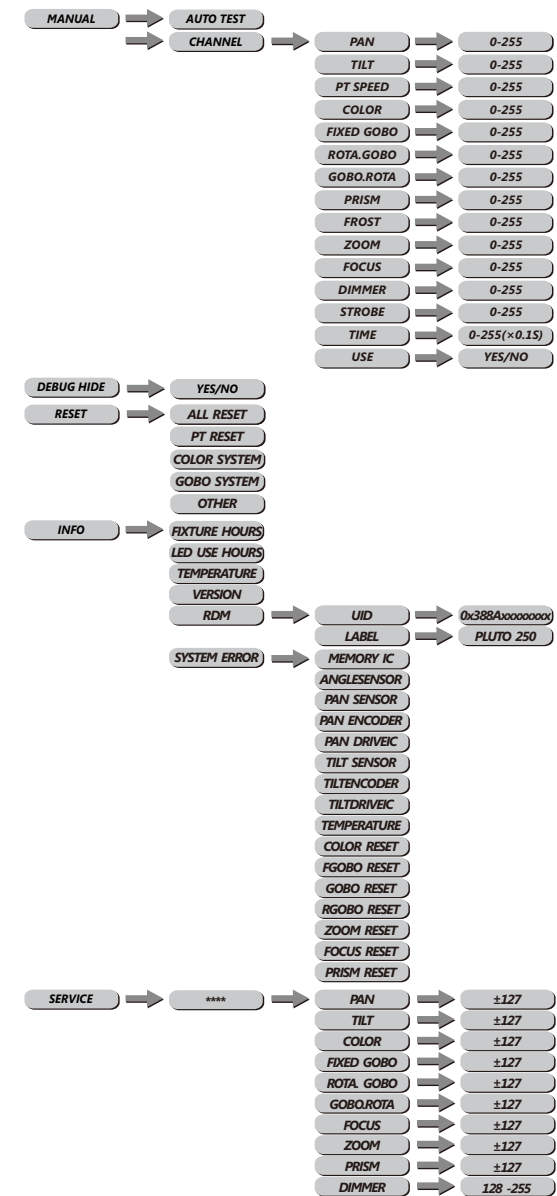

3.3 DMX Address



- Enter the **【DMX】** mode to set the DMX address.
- Enter Up/Down select **【1~512】** address.
- Enter **【MENU】** return.

3.4 Personality(Person)



- Enter the **【PERSON】** mode to select DMX mode: **【STANDRAD】** , **【BASIC】** .

3.5 Runmode



- **【RUNMODE】** menu, select required run mode, there are six modes inside: **【DMX512】** DMX512 mode, **【AUTO】** auto run mode, **【CUSTOM1】** customer self-editing scene mode 1, **【CUSTOM2】** customer self-editing scene mode 2 press Down/Up select mode.
- press **【ENTER】** accept, press **【MENU】** return.

3.6 Performance (Option)

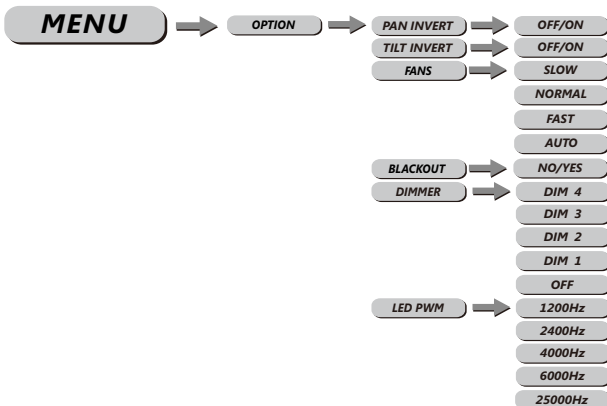

4 Using a DMX512 Controller

4.1 Channel Assignment

Note: this product have two DMX512 channel configuration: **【STANDARD】** , **【BASIC】** .

STANDARD

CHANNEL	VALUE	FUNCTION
CH.1	000 ↔ 255	PAN 0-540°
CH.2	000 ↔ 255	PAN FINE
CH.3	000 ↔ 255	TITL 0-270°
CH.4	000 ↔ 255	TITL FINE
CH.5	000 ↔ 255	PT SPEED
		COLOR WHEEL 8+1
	000 ↔ 007	WHITE
	008 ↔ 014	COLOR01
	015 ↔ 021	COLOR02
	022 ↔ 028	COLOR03
	029 ↔ 035	COLOR04
CH.6	036 ↔ 042	COLOR05
	043 ↔ 049	COLOR06
	050 ↔ 056	COLOR07
	057 ↔ 063	COLOR08
	064 ↔ 191	COLOR WHEEL 0-360°
	192 ↔ 222	COLOR WHEEL RAINBOW EFFECT (SPEED 100%->1)
	223 ↔ 224	STOP
	225 ↔ 255	COLOR WHEEL RAINBOW EFFECT (SPEED 1-> 100%)
CH.7	000 ↔ 255	COLOR WHEEL FINE ADJUSTMENT. AVAILABLE WHEN THE VALUE IS UNDER 128 ON CHANNELS 10.
		STATIC GOBO 11+1
	000 ↔ 010	WHITE
	011 ↔ 015	GOBO1
	016 ↔ 020	GOBO2
	021 ↔ 025	GOBO3
	026 ↔ 030	GOBO4
	031 ↔ 035	GOBO5
	036 ↔ 040	GOBO6
	041 ↔ 045	GOBO7
	046 ↔ 050	GOBO8

- 【TEMPERATURE】 is led temperature.
- 【VERSION】 is software versions;
- 【NETWORK PARA】 check network parameter;
- 【RDM】 check fixture's ID;
- 【SYSTEM ERROR】 system information error : Memory IC, Angle Sensor, Pan Sensor, Pan Encoder, Pan Drive IC, Tilt Sensor, Tilt Encoder, Tilt Drive IC, Temperature, Color Reset, FGobo Reset, Gobo Reset, RGobo Reset, Zoom Reset, Focus Reset, Prism Reset.

3.10 Service

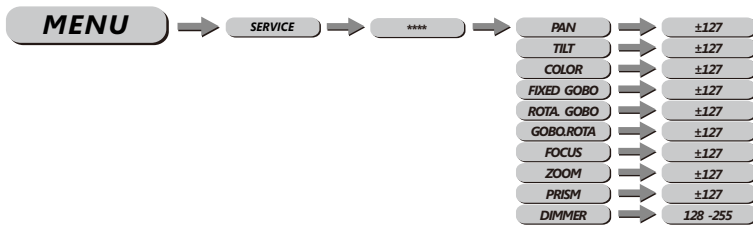

- Press 【ENTER】 into 【SERVICE】 enter password "up down up down" to enter the options page.
- 【PAN】 Pan position fine adjustment. push up and down buttons adjust ± 127 value.
- 【TILT】 tilt position fine adjustment. push up and down buttons adjust ± 127 value.
- 【COLOR】 color position fine adjustment, Push up and down buttons adjust ± 127 value.
- 【FIXED GOBO】 fix gobo position fine adjustment, Push up and down buttons adjust ± 127 value.
- 【ROTA. GOBO】 rotation gobo position fine adjustment, Push up and down buttons adjust ± 127 value.
- 【GOBO.ROTA】 gobo self-rotation position fine adjustment, Push up and down buttons adjust ± 127 value.
- 【FOCUS】 focus position fine adjustment, Push up and down buttons adjust ± 127 value.
- 【ZOOM】 zoom position fine adjustment, Push up and down buttons adjust ± 127 value.
- 【PRISM】 prism position fine adjustment, Push up and down buttons adjust ± 127 value.
- 【DIMMER】 is a dimming setting that limits the maximum brightness, range of values is 128~255 the lower the value, the higher the limit, 255 is unlimited.

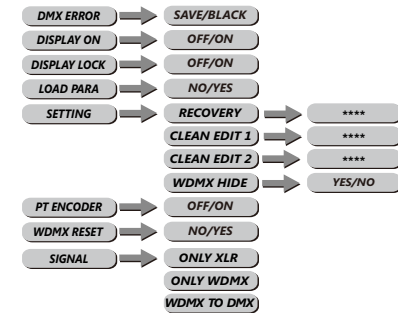

- Enter 【OPTION】 into the machine set.
- 【PAN INVERT】 menu, select 【NORMAL】 for normal direction, select 【INVERT】 for inverted of the PAN direction.
- 【FANS】 menu, select 【Slow/Normal/Fast/Auto】 as required fan speed.
- Choose 【OFF】 and 【ON】 to close and open the 【BLACKOUT】 mode.
- 【DIMMER】 menu for selection of 【DIM1/DIM2/DIM3/DIM4/OFF】 special dimming curves.
- 【LED PWM】 is PWM refresh rate bottom, press UP/DOWN to choose <1200Hz>, <2000Hz>, <2400Hz>, <6000Hz>, <25000Hz>; Attention: the gray level of dimming will be reduced as the refresh rate increases.
- 【DMX ERROR】 menu, select 【SAVE】 to maintain last command in case of DMX error or for blackout.
- Choose 【OFF】 and 【ON】 to close and open the display open & close mode in menu 【DISPLAY】
- Choose 【OFF】 and 【ON】 to close and open the screen lock mode in menu 【DISPLAY LOCK】
- 【LOAD PARA】 is parameter upload Settings, enter 【NO】 do not upload, enter 【YES】 upload.
- 【SETTING】 maintain settings, select 【RECOVERY】 is restore default factory settings. press 【ENTER】 enter password then press 【ENTER】, if your password correct there will display 【OK】 .
 【CLEAN EDIT1】 clean customer self-editing scene 1, press 【ENTER】 confirm.
 【CLEAN EDIT2】 clean customer self-editing scene 2, press 【ENTER】 confirm.
 【WDMX HIDE】 hide wireless mode, WDMX RESET and SIGNAL hide and the default is wired mode only.

- **【PT ENCODER】** XY encoderswitch, **【OFF】** is close, **【ON】** is open. **【WDMX RESET】** wireless resetting, use for patch wireless signal, **【YES】** is clear the receiver's message, press again patch wireless signal, **【No】** do not clear the receiver's message.
- **【SIGNAL】** is signal setting, ONLY XLR is wire only, XLR FIRST is wire first, ONLY WDMX is wireless only. WDMX FIRS is wireless first, WDMX TO DMX is wireless to wired.

3.7 Edit

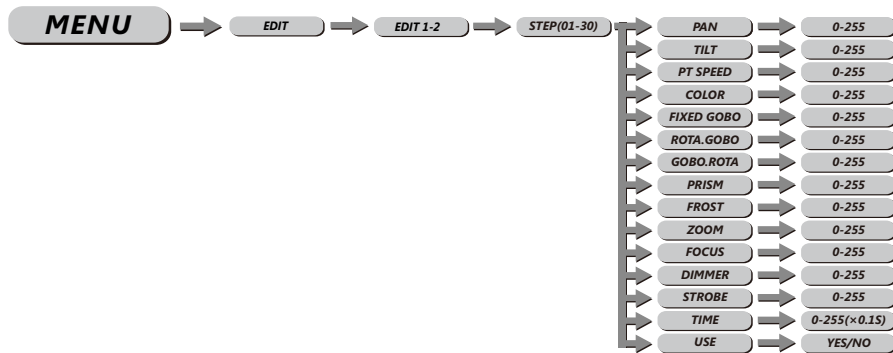

- Enter the **【EDIT】** mode to edit the custom programs by adjusting the value of **【PAN】**, **【TILT】**, **【PTSPEED】**, **【COLOR】**, **【FIXED GOBO】**, **【ROTA.GOBO】**, **【GOBO.ROTA】**, **【PRISM】**, **【FROST】**, **【ZOOM】**, **【FOCUS】**, **【DIMMER】**, **【STROBE】**, **【TIME】**. Enter **【Use】** and select **【Yes】** to run the steps user need.

3.8 Manual control mode

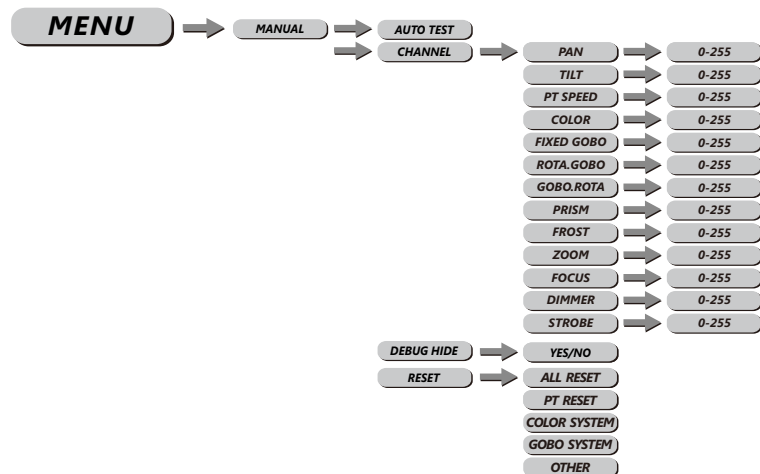

- Press **【ENTER】** into **【AUTOTEST】** at **【MENU】**.
- **【PAN】** pan set, **【TILT】** tilt set, **【PT SPEED】** set the pan & tilt speed, **【COLOR】** color temperature, **【FIXED GOBO】** set the static gobo wheel **【ROTA.GOBO】** set the rotating gobo wheel, **【GOBO.ROTA】** set the autogiration of gobo wheel, **【PRISM】** set the prism, **【FROST】** set the frost lens, **【ZOOM】** set the zoom of fixture, **【FOCUS】** set the focusing, **【DIMMER】** set the dimmer, **【STROBE】** set the strobe, push the UP/DOWN to set the value **【000~255】**.
- **【DEBUG HIDE】** is the factory testing mode. All stepper motors are not controlled by signal. It only works again after the reset. enter No out、enter Yes in.
- **【RESET】** set the reset:
【ALL RESET】 menu, select Yes/No to carry out all reset.
【PT RESET】 menu, select Yes/No to carry out PAN/TILT reset.
【COLOR SYSTEM】 color wheel、CMY resetting, press No do not resetting, press Yes resetting.
【GOBO SYSTEM】 fix gobo resetting. press No do not resetting, press Yes resetting.
【OTHER】 focus、zoom、prism、frost、iris, press No do not resetting, press Yes resetting.

3.9 Info

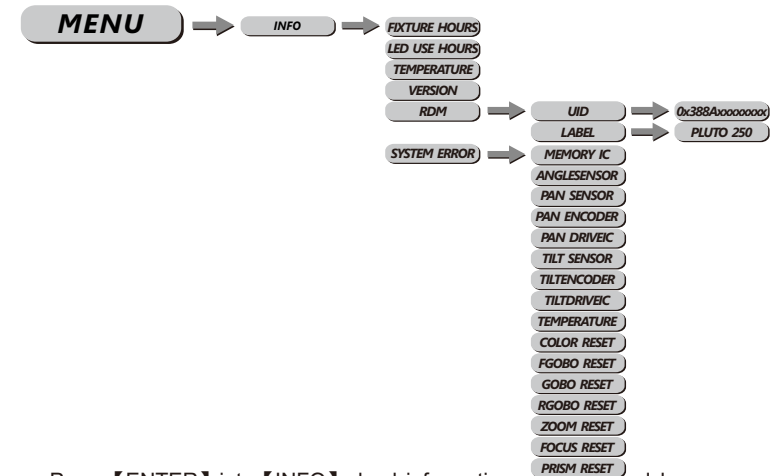

- Press **【ENTER】** into **【INFO】** check information, press up and down
- **【FIXTURE HOURS】** is hours of fixture use;
- **【LED USE HOURS】** is LED use time;