

Portable Speakers

NuQ

NuQ102-WH

2 Way 10" Full Range Loudspeaker
for Portable PA and
Installation Applications (White)

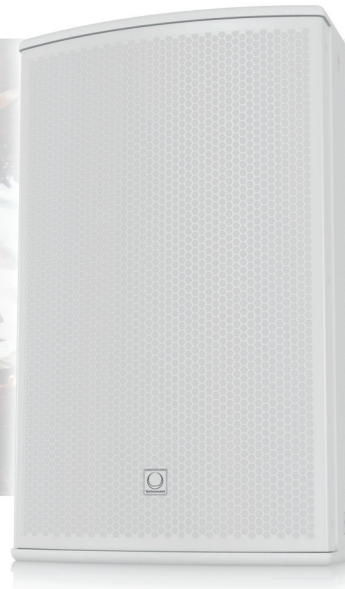

- 2 way full range loudspeaker for portable PA and installation applications
- 300 Watts continuous, 1,200 Watts peak power
- Ideal for FOH, side fill and monitor applications
- 10" low frequency driver with low mass voice coil for improved transient response
- Aluminium dome 1" neodymium motor compression driver
- Switchable passive/bi-amp operation for flexibility of use
- Rotatable converging elliptical waveguide provides 100° H x 60° V dispersion
- 12 mm (½") birch plywood enclosure with hard wearing semi matt white paint finish
- Rugged powder coated perforated steel mesh grille
- Integral 35 mm pole mount and handles
- Multiple internal rigging points allow bracket mount and suspension in any orientation
- Neutrik speakON* NL4 connectors for reliable long life operation
- 3-Year Warranty Program*
- Designed and engineered in England

The 2 way full range NuQ102-WH is a switchable passive/bi-amp 1,200 Watt 10" loudspeaker system ideally suited for a wide range of speech and music sound reinforcement applications. Engineered to work in conjunction with [Turbosound](#) loudspeaker management systems, the NuQ102-WH provides optimal performance for FOH, sidefill and delay line loudspeakers, and is an exceptional choice for wedge monitoring applications.



The NuQ102-WH loudspeaker features a 10" low frequency driver with a low mass voice coil for improved transient response, and an aluminium dome 1" neodymium high frequency compression driver mounted on a rotatable 100° horizontal by 60° vertical dispersion converging elliptical waveguide. All drivers are matched with an internal passive crossover network in a reflex-loaded enclosure, and bi-amp mode can be enabled by means of a rear panel switch. The rear panel connector plate carries Neutrik speakON* NL4 connectors for input and link connections to additional enclosures.

Finished in a highly durable semi matt white paint, the cabinet is constructed from 12 mm (½") birch plywood – and includes a rugged powder coated perforated steel mesh grille backed with reticulated foam. Multiple threaded rigging points are provided for suspension in any orientation, or for mounting with industry standard wall brackets. Optional flying yoke, swivel brackets, and swivel extenders allow for further flexibility in install applications (each available separately). The NuQ102-WH also features a 35 mm socket for standard pole mounting – plus integrated handles for convenient transport.

*All third-party trademarks are the property of their respective owners. Their use neither constitutes a claim of the trademark nor affiliation of the trademark owners with Music Group. Product names are mentioned solely as a reference for compatibility, effects and/or components. Warranty details can be found at music-group.com.

Portable Speakers

NuQ

NuQ102-WH

2 Way 10" Full Range Loudspeaker
for Portable PA and
Installation Applications (White)



You Are Covered

We always strive to provide the best possible Customer Experience. Our products are made in our own [Music Group](#) factory using state-of-the-art automation, enhanced production workflows and quality assurance labs with the most sophisticated test equipment available in the world. As a result, we have one of the lowest product failure rates in the industry, and we confidently back it up with a generous [3-Year Warranty program](#).

Portable Speakers

NuQ

NuQ102-WH

2 Way 10" Full Range Loudspeaker
for Portable PA and
Installation Applications (White)

Frequency Response Sensitivity 1 W / 1 m

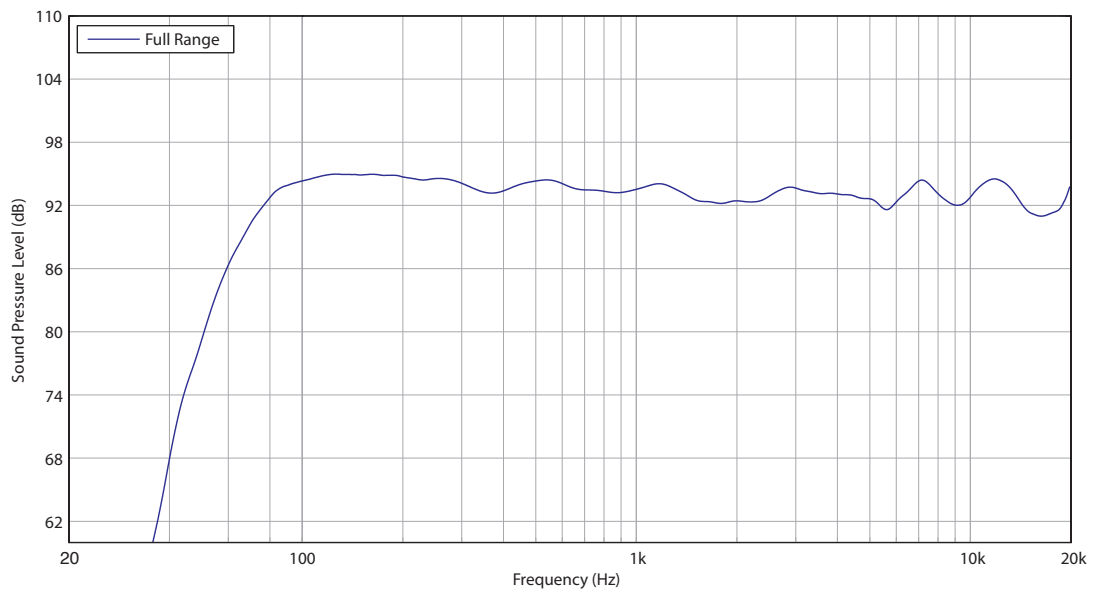

Impedance

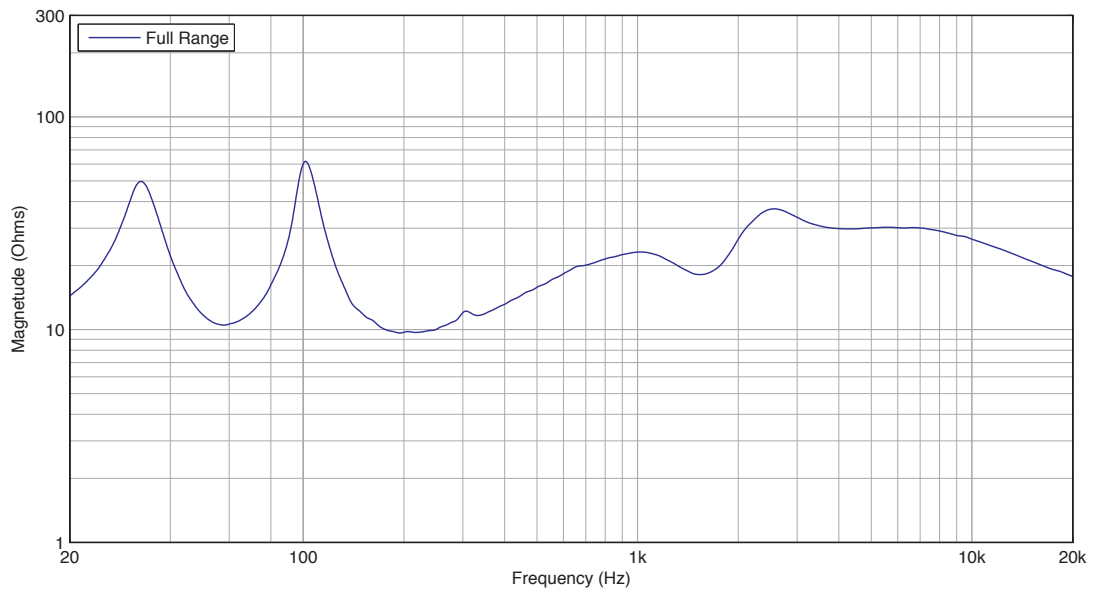

Portable Speakers

NuQ

NuQ102-WH

2 Way 10" Full Range Loudspeaker
for Portable PA and
Installation Applications (White)

Horizontal Beamwidth

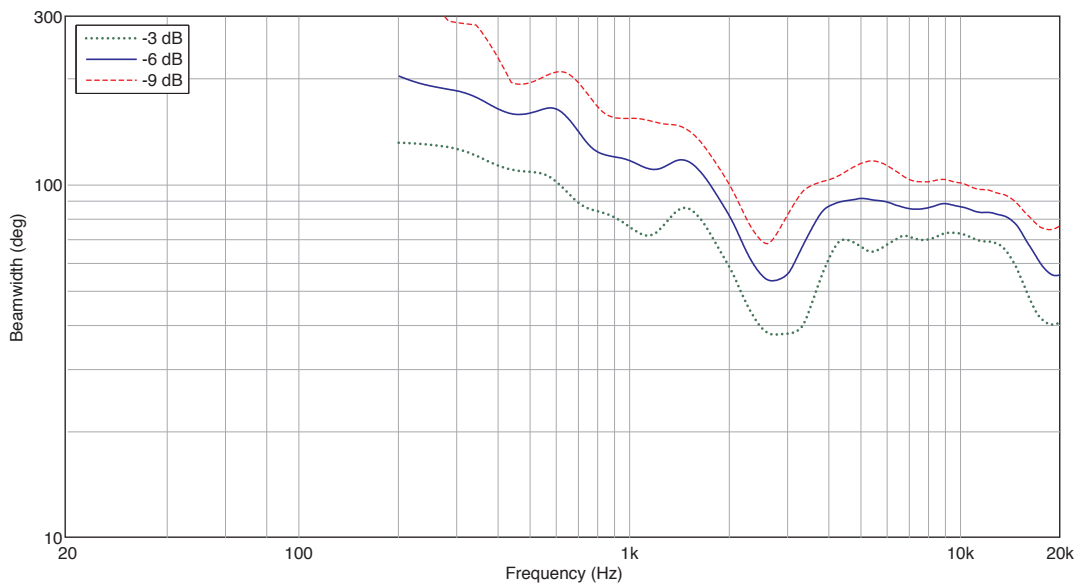

Vertical Beamwidth

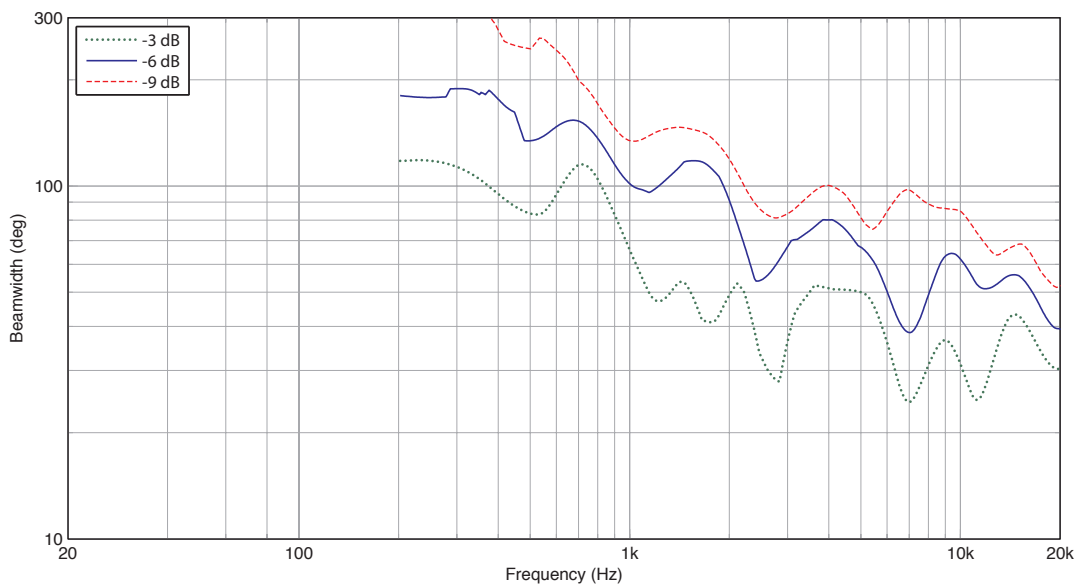

Portable Speakers

NuQ

NuQ102-WH

2 Way 10" Full Range Loudspeaker
for Portable PA and
Installation Applications (White)

Horizontal Polar Plots

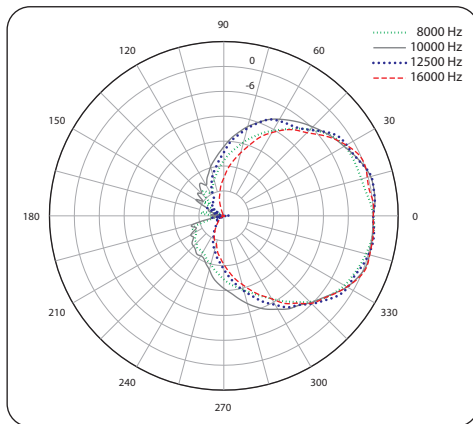
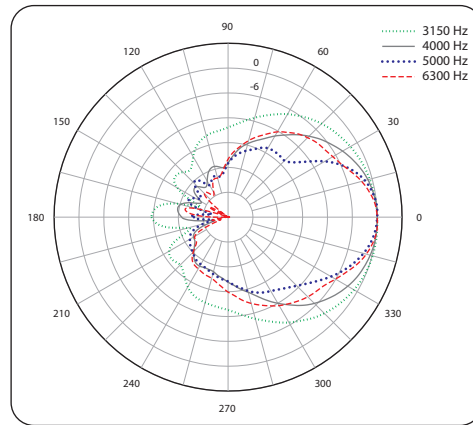
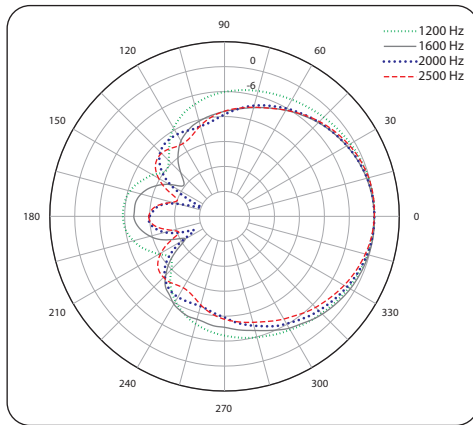
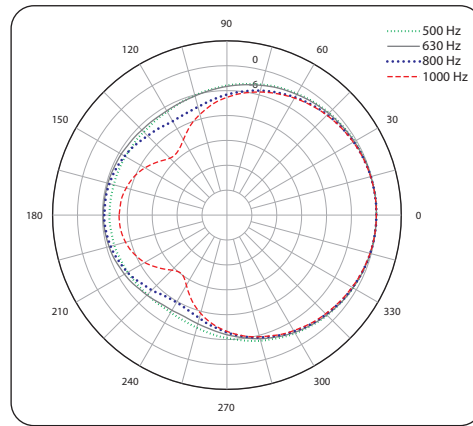
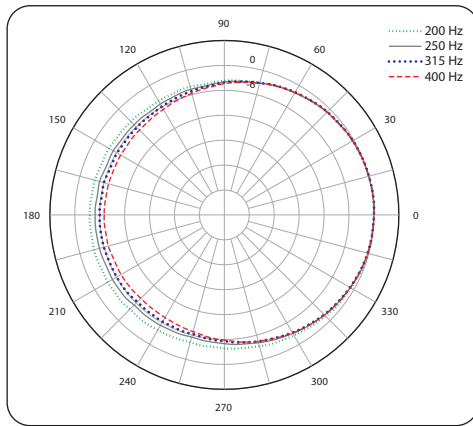

Portable Speakers

NuQ

NuQ102-WH

2 Way 10" Full Range Loudspeaker
for Portable PA and
Installation Applications (White)

Vertical Polar Plots

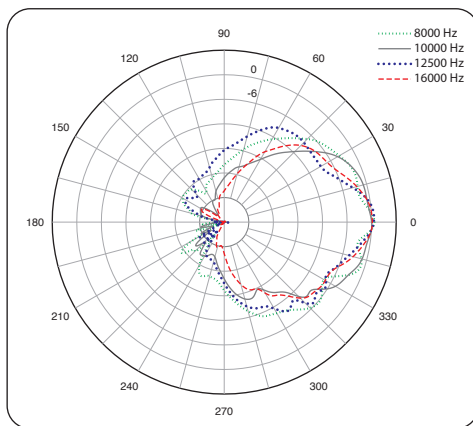
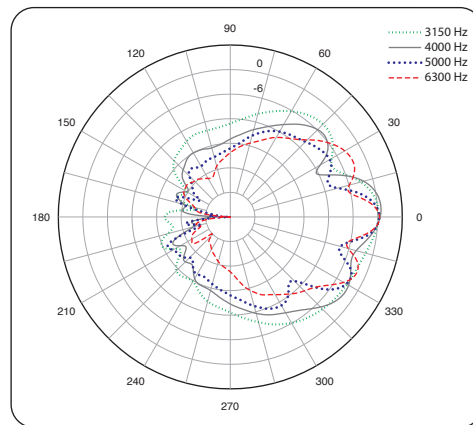
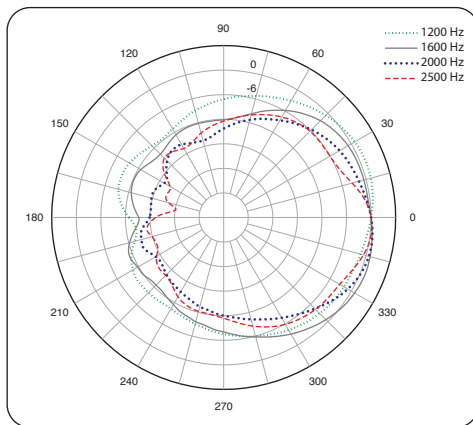
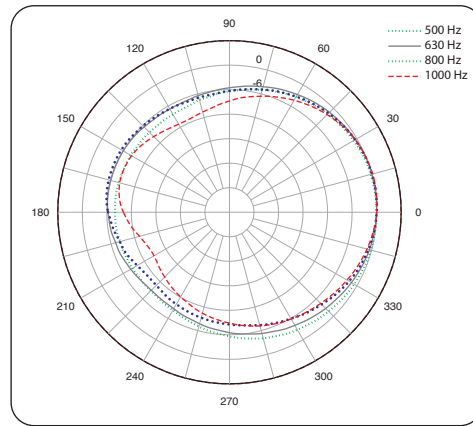
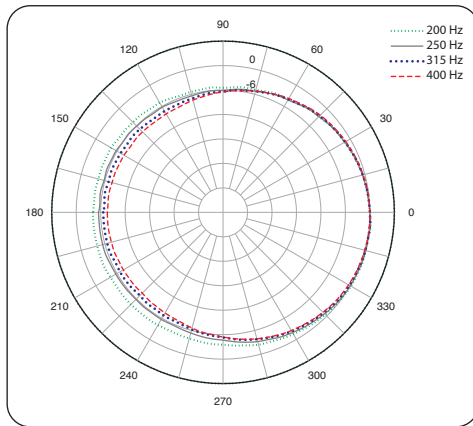

Portable Speakers

NuQ

NuQ102-WH

2 Way 10" Full Range Loudspeaker
for Portable PA and
Installation Applications (White)

Dimensions

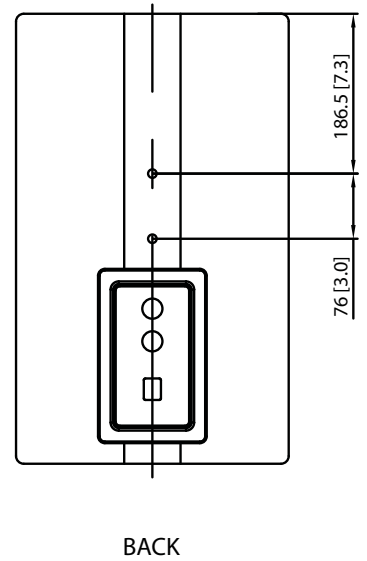
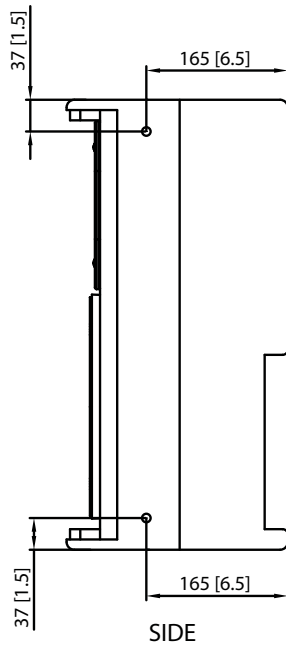
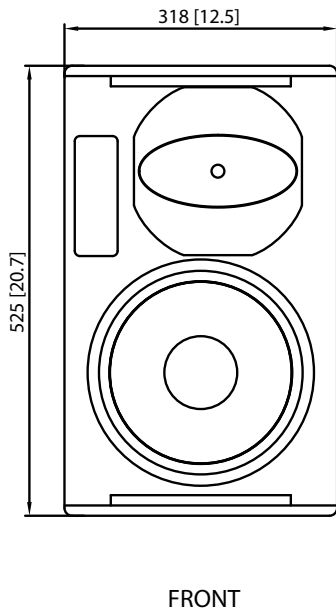
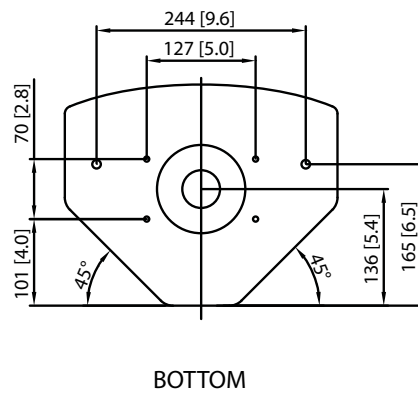
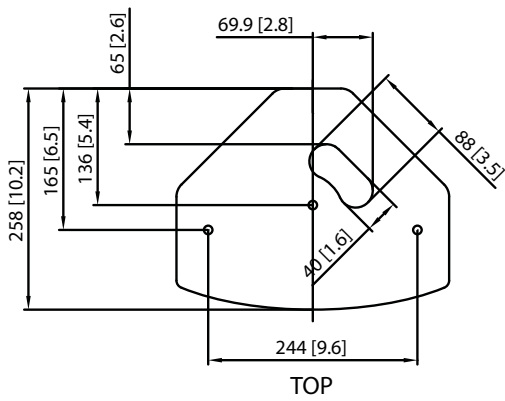

Portable Speakers

NuQ

NuQ102-WH

2 Way 10" Full Range Loudspeaker
for Portable PA and
Installation Applications (White)

Mounting and Rigging

The cabinet is fitted with M10 x 8, M8 x 3, and M6 x 4 internally-threaded rigging points that allow it to be rigged with optional shoulder eyebolts and mounted in many different configurations in permanent installations. The simplest method of rigging is to use the two M10 rigging points on the top, and a single pull-back rigging point in the centre of the rear panel. Adjustment of the length of the rear cable allows the cabinet to be angled for optimum room coverage. Cabinets may also be hung upside down if required.

The cabinet has an integral 35 mm pole mount socket in the bottom panel, that allows it to be pole mounted. The cabinet is compatible with [Turbosound](#) brackets, and industry standard brackets.

The optional [NuQ102-SB](#) swivel bracket allows the cabinet to be surface mounted and angled for optimum positioning and coverage. The [NuQ102-EB](#) extender bracket allows cabinets to be arrayed, and the [NuQ102-FY](#) fly yoke adds further installation flexibility for scaffold, surface, and pole mounting.

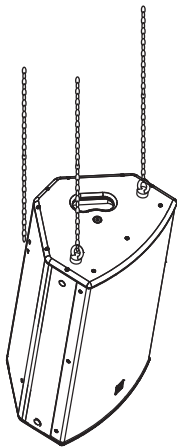

Suspension using M10 shoulder eyebolts.

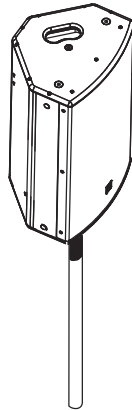

Mounting on 35 mm pole or speaker stand.

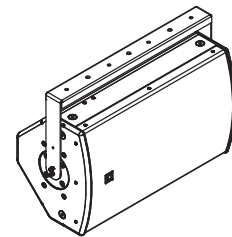

NuQ102-SB swivel bracket for surface mounting.

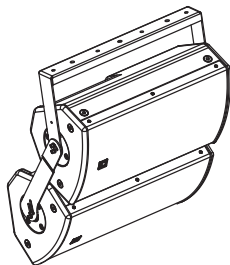

NuQ102-SB bracket with NuQ102-EB extender brackets, creating an array.

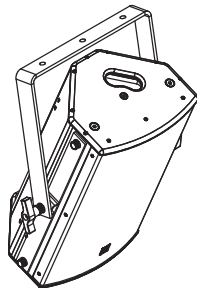

NuQ102-FY fly yoke.

Portable Speakers

NuQ

NuQ102-WH

2 Way 10" Full Range Loudspeaker
for Portable PA and
Installation Applications (White)

Technical Specifications

System

Frequency Response	55 Hz – 18 kHz \pm 3 dB 50 Hz – 20 kHz -10 dB
Nominal Dispersion	100° H x 60° V @ -6 dB points, rotatable
Directivity Factor (Q)	8
Directivity Index (DI)	9
Power Handling (IEC)	
Passive	300 W continuous, 1,200 W peak
Bi-amp	LF: 300 W continuous, 1,200 W peak HF: 30 W continuous, 120 W peak
Sensitivity	93 dB (1 W @ 1 m)
Maximum SPL	
Passive	118 dB continuous, 124 dB peak
Bi-Amp	LF: 118 dB continuous, 124 dB peak HF: 119 dB continuous, 125 dB peak
Impedance	
Passive	8 Ohms
Bi-Amp	LF: 8 Ohms HF: 6 Ohms
Crossover Type	Passive / bi-amp, switchable
Components	1 x 10" (261 mm) LF driver 1 x 1" (25 mm) HF compression driver

Enclosure

Connectors	2 x Neutrik speakON* NL4
Wiring	
Passive	Pins 1+ / 1- input, pins 2+ / 2- link
Bi-Amp	Pins 1+ / 1- LF, pins 2+ / 2- HF
Dimensions (HWD)	525 x 318 x 258 mm (20.7 x 12.5 x 10.2")
Net Weight	12.7 kg (27.9 lbs)
Construction	12 mm (1/2") birch plywood
Finish	Semi matt white paint
Grille	Powder-coated perforated steel
Flying Hardware	M10 x 8, M8 x 3, and M6 x 4 points

Accessories

NuQ102-SB
NuQ102-EB
NuQ102-FY

Portable Speakers

NuQ

NuQ102-WH

2 Way 10" Full Range Loudspeaker
for Portable PA and
Installation Applications (White)

Architecture & Engineering Specifications

The speaker shall be of the full range, two-way switchable bi-amp/passive type consisting of one 10" (261 mm) LF driver and one 1" (25 mm) HF compression driver. Performance specifications of a typical production unit shall meet or exceed the following: frequency response, measured with swept sine wave input, shall be flat within ± 3 dB from 55 Hz to 18 kHz and within -10 dB from 50 Hz to 20 kHz. Nominal dispersion, at -6 dB points, shall average 100° H x 60° V, rotatable. Nominal impedance shall be HF: 6 Ohms, LF: 8 Ohms; passive: 8 Ohms. Power handling shall be HF: 30 Watts continuous, 120 Watts peak, LF: 300 Watts continuous, 1,200 Watts peak; passive: 300 Watts continuous, 1,200 Watts peak. Sensitivity, measured on axis, mean averaged over stated bandwidth, shall be 93 dB, 1 Watt @ 1 metre. Maximum SPL (peak), measured at 1 metre with music program at stated amplifier input, shall be HF: 125 dB, LF: 124 dB; passive: 124 dB. Dimensions: 525 mm high x 318 mm wide x 258 mm deep (20.7" x 12.5" x 10.2"). Net weight: 12.7 kg (27.9 lbs). The loudspeaker system shall be the [Turbosound NuQ102-WH](#). No other loudspeaker shall be acceptable unless submitted data from an independent test laboratory verifies that the above combined performance / size specifications are equaled or exceeded.

Portable Speakers

NuQ

NuQ102-WH

2 Way 10" Full Range Loudspeaker
for Portable PA and
Installation Applications (White)



Portable Speakers

NuQ

NuQ102-WH

2 Way 10" Full Range Loudspeaker
for Portable PA and
Installation Applications (White)

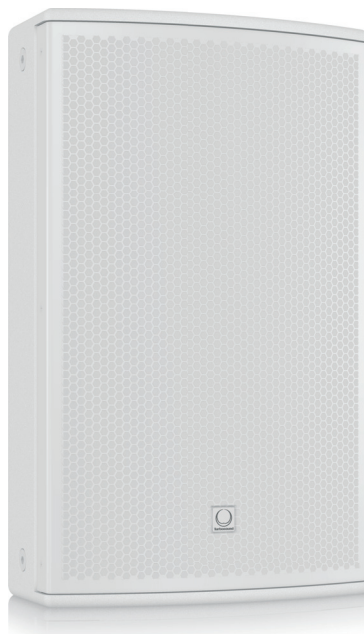
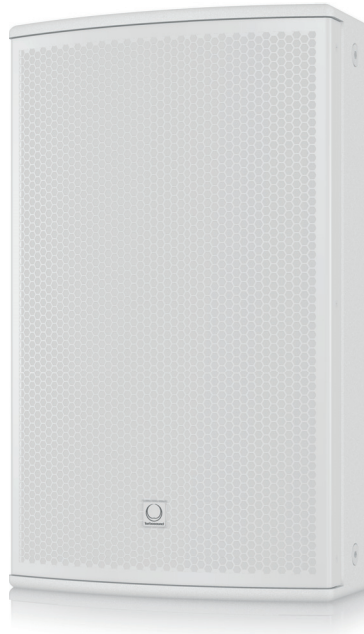

Portable Speakers

NuQ

NuQ102-WH

2 Way 10" Full Range Loudspeaker
for Portable PA and
Installation Applications (White)



For service, support or more information contact the Turbosound location nearest you:

Europe
Music Group Services UK
Tel: +44 156 273 2290
Email: CARE@music-group.com

USA/Canada
Music Group Services NV Inc.
Tel: +1 702 800 8290
Email: CARE@music-group.com

Japan
Music Group Services JP K.K.
Tel: +81 3 6231 0454
Email: CARE@music-group.com

Music Group accepts no liability for any loss which may be suffered by any person who relies either wholly or in part upon any description, photograph, or statement contained herein. Technical specifications, appearances and other information are subject to change without notice. All trademarks are the property of their respective owners. Midas, Klark Teknik, Lab Gruppen, Lake, Tannoy, Turbosound, TC Electronic, TC Helicon, Behringer, Bugera, DDA and TC Applied Technologies are trademarks or registered trademarks of Music Group IP Ltd. © Music Group IP Ltd. 2015 All rights reserved.