

# TASCAM

D01249320A

# DA-6400

# DA-6400dp

## Digital Multitrack Recorder

### OWNER'S MANUAL

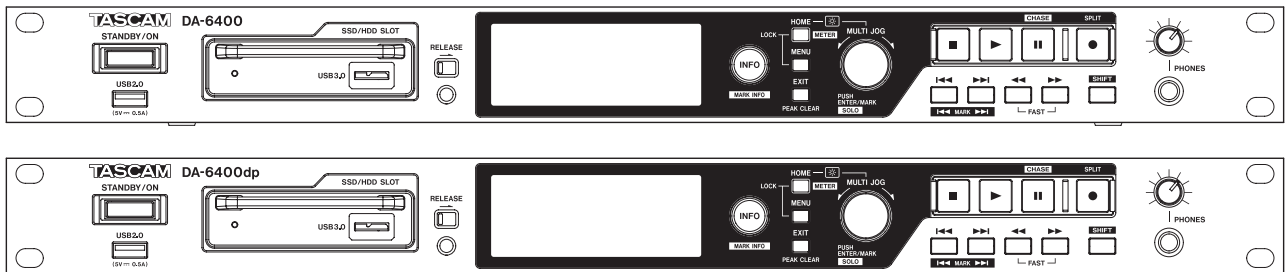

# IMPORTANT SAFETY PRECAUTIONS



**CAUTION**  
RISK OF ELECTRIC SHOCK  
DO NOT OPEN



CAUTION: TO REDUCE THE RISK OF ELECTRIC SHOCK, DO NOT REMOVE COVER (OR BACK). NO USER-SERVICEABLE PARTS INSIDE. REFER SERVICING TO QUALIFIED SERVICE PERSONNEL.



The lightning flash with arrowhead symbol, within equilateral triangle, is intended to alert the user to the presence of uninsulated "dangerous voltage" within the product's enclosure that may be of sufficient magnitude to constitute a risk of electric shock to persons.



The exclamation point within an equilateral triangle is intended to alert the user to the presence of important operating and maintenance (servicing) instructions in the literature accompanying the appliance.

**WARNING: TO PREVENT FIRE OR SHOCK HAZARD, DO NOT EXPOSE THIS APPLIANCE TO RAIN OR MOISTURE.**

## DECLARATION OF CONFORMITY

We, TEAC EUROPE GmbH, Bahnstrasse 12, 65205 Wiesbaden-Erbenheim, Germany declare in own responsibility, the TEAC product described in this manual is in compliance with the corresponding technical standards.



## For U.S.A.

This device complies with Part 15 of FCC Rules. Operation is subject to the following two conditions:

- 1) This device may not cause harmful interference, and
- 2) This device must accept any interference received, including interference that may cause undesired operation.

### INFORMATION TO THE USER

This equipment has been tested and found to comply with the limits for a Class A digital device, pursuant to Part 15 of the FCC Rules. These limits are designed to provide reasonable protection against harmful interference when the equipment is operated in a commercial environment. This equipment generates, uses, and can radiate radio frequency energy and, if not installed and used in accordance with the instruction manual, may cause harmful interference to radio communications.

Operation of this equipment in a residential area is likely to cause harmful interference in which case the user will be required to correct the interference at his own expense.

### CAUTION

Changes or modifications to this equipment not expressly approved by TEAC CORPORATION for compliance could void the user's authority to operate this equipment.

**IN USA/CANADA, USE ONLY ON 120 V SUPPLY.**

## For Canada

THIS CLASS A DIGITAL APPARATUS COMPLIES WITH CANADIAN ICES-003.

CET APPAREIL NUMERIQUE DE LA CLASSE A EST CONFORME A LA NORME NMB-003 DU CANADA.

## CE Marking Information

- a) Applicable electromagnetic environment: E4
- b) The average half-cycle r.m.s. inrush current
  1. On initial switch-on: 2.91 Arms
  2. After a supply interruption of 5s: 0.15 Arms

## For the customers in Europe

### WARNING

This is a Class A product. In a domestic environment, this product may cause radio interference in which case the user may be required to take adequate measures.

## Pour les utilisateurs en Europe

### AVERTISSEMENT

Il s'agit d'un produit de Classe A. Dans un environnement domestique, cet appareil peut provoquer des interférences radio, dans ce cas l'utilisateur peut être amené à prendre des mesures appropriées.

## Für Kunden in Europa

### Warnung

Dies ist eine Einrichtung, welche die Funk-Entstörung nach Klasse A besitzt. Diese Einrichtung kann im Wohnbereich Funkstörungen verursachen; in diesem Fall kann vom Betreiber verlangt werden, angemessene Maßnahmen durchzuführen und dafür aufzukommen.

# IMPORTANT SAFETY INSTRUCTIONS

- 1 Read these instructions.
- 2 Keep these instructions.
- 3 Heed all warnings.
- 4 Follow all instructions.
- 5 Do not use this apparatus near water.
- 6 Clean only with dry cloth.
- 7 Do not block any ventilation openings. Install in accordance with the manufacturer's instructions.
- 8 Do not install near any heat sources such as radiators, heat registers, stoves, or other apparatus (including amplifiers) that produce heat.
- 9 Do not defeat the safety purpose of the polarized or grounding-type plug. A polarized plug has two blades with one wider than the other. A grounding type plug has two blades and a third grounding prong. The wide blade or the third prong are provided for your safety. If the provided plug does not fit into your outlet, consult an electrician for replacement of the obsolete outlet.
- 10 Protect the power cord from being walked on or pinched particularly at plugs, convenience receptacles, and the point where they exit from the apparatus.
- 11 Only use attachments/accessories specified by the manufacturer.
- 12 Use only with the cart, stand, tripod, bracket, or table specified by the manufacturer, or sold with the apparatus. When a cart is used, use caution when moving the cart/apparatus combination to avoid injury from tip-over.



- 13 Unplug this apparatus during lightning storms or when unused for long periods of time.
- 14 Refer all servicing to qualified service personnel. Servicing is required when the apparatus has been damaged in any way, such as power-supply cord or plug is damaged, liquid has been spilled or objects have fallen into the apparatus, the apparatus has been exposed to rain or moisture, does not operate normally, or has been dropped.

- The apparatus draws nominal non-operating power from the AC outlet with its POWER or STANDBY/ON switch not in the ON position.
- The mains plug is used as the disconnect device, the disconnect device shall remain readily operable.
- Caution should be taken when using earphones or headphones with the product because excessive sound pressure (volume) from earphones or headphones can cause hearing loss.
- If you are experiencing problems with this product, contact TEAC for a service referral. Do not use the product until it has been repaired.

## CAUTION

- Do not expose this apparatus to drips or splashes.
- Do not place any objects filled with liquids, such as vases, on the apparatus.
- Do not install this apparatus in a confined space such as a book case or similar unit.
- The apparatus should be located close enough to the AC outlet so that you can easily grasp the power cord plug at any time.
- If the product uses batteries (including a battery pack or installed batteries), they should not be exposed to sunshine, fire or excessive heat.
- CAUTION for products that use replaceable lithium batteries: there is danger of explosion if a battery is replaced with an incorrect type of battery. Replace only with the same or equivalent type.

## WARNING

- Products with Class I construction are equipped with a power supply cord that has a grounding plug. The cord of such a product must be plugged into an AC outlet that has a protective grounding connection.

## ■ RACK-MOUNTING THE UNIT

Use the supplied rack-mounting kit to mount the unit in a standard 19-inch rack, as shown below.

Remove the feet of the unit before mounting.

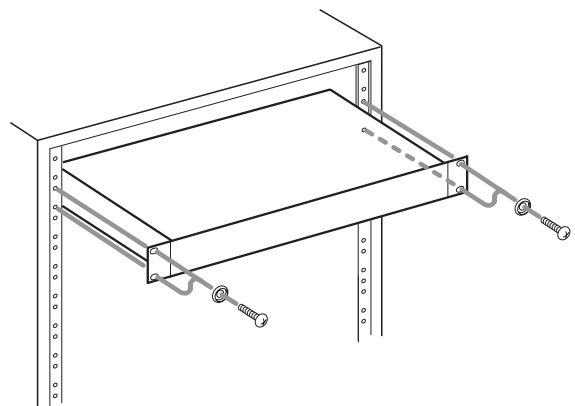

## CAUTION

- Leave 1U of space above the unit for ventilation.
- Allow at least 10 cm (4 in) at the rear of the unit for ventilation.

# Safety Information

## ■ For European Customers

### Disposal of electrical and electronic equipment

- (a) All electrical and electronic equipment should be disposed of separately from the municipal waste stream via designated collection facilities appointed by the government or the local authorities.
- (b) By disposing of the electrical and electronic equipment correctly, you will help save valuable resources and prevent any potential negative effects on human health and the environment.
- (c) Improper disposal of waste equipment can have serious effects on the environment and human health as a result of the presence of hazardous substances in electrical and electronic equipment.
- (d) The crossed out wheeled dust bin symbol indicates that electrical and electronic equipment must be collected and disposed of separately from household waste.



- (e) The return and collection systems are available to the end users. For more detailed information about disposal of old electrical and electronic equipment, please contact your city office, waste disposal service or the shop where you purchased the equipment.

### Disposal of batteries and/or accumulators

- (a) Waste batteries and/or accumulators should be disposed of separately from the municipal waste stream via designated collection facilities appointed by the government or the local authorities.
- (b) By disposing of waste batteries and/or accumulators correctly, you will help save valuable resources and prevent any potential negative effects on human health and the environment.
- (c) Improper disposal of waste batteries and/or accumulators can have serious effects on the environment and human health as a result of the presence of hazardous substances in batteries and/or accumulators.
- (d) The crossed out wheeled dust bin symbol indicates that batteries and/or accumulators must be collected and disposed of separately from household waste.

If the battery or accumulator contains more than the specified values of lead (Pb), mercury (Hg), and/or cadmium (Cd) defined in the Battery Directive (2006/66/EC), then the chemical symbols for lead (Pb), mercury (Hg) and/or cadmium (Cd) will be indicated beneath the crossed out wheeled dust bin symbol.



Pb, Hg, Cd

- (e) The return and collection systems are available to the end users. For more detailed information about disposal of waste batteries and/or accumulators, please contact your city office, waste disposal service or the shop where you purchased them.

## ■ For China



“仅适用于海拔 2000m 以下地区安全使用”



“仅适用于非热带气候条件下安全使用”



“环境保护使用年限”

产品有毒有害物质或元素的名称及含量

机种：DA-6400		有毒有害物质或元素					
	品名	铅 (Pb)	汞 (Hg)	镉 (Cd)	六价铬 (Cr6+)	多溴联苯 (PBB)	多溴二苯醚 (PBDE)
1	CHASSIS 部份	○	○	○	○	○	○
2	FRONT PANEL 部份	○	○	○	○	○	○
3	螺丝部份	○	○	○	○	○	○
4	线材部份	○	○	○	○	○	○
5	PCB Assy 部份	×	○	○	○	○	○
6	电源部份	○	○	○	○	○	○
7	附属品部份	×	○	○	○	○	○
8	LABEL 部份	○	○	○	○	○	○
9	包装部份	○	○	○	○	○	○

○：表示该有毒有害物质在该部件所有均质材料中的含量均在 GB/T26572-2011 标准规定的限量要求以下。

×：表示该有毒有害物质至少在该部件的某一均质材料中的含量超出 GB/T26572-2011 标准规定的限量要求。

(针对现在代替技术困难的电子部品及合金中的铅)

<b>1 – Introduction .....</b>	<b>7</b>	Setting the file name format .....	26
Features .....	7	Editing text .....	26
Included items .....	7	Automatically incrementing take numbers .....	27
Conventions used in this manual .....	7	Incrementing take numbers manually .....	27
Trademarks .....	7	Adding marks automatically when recording .....	27
Precautions for placement and use .....	8	Adding marks manually when recording .....	28
Notes about power supplies .....	8	Adding marks when recording .....	28
Beware of condensation .....	8	Setting the pause mode function .....	28
Cleaning the unit .....	8	Setting input signal routing .....	28
Notes about SSD and HDD drives .....	8	Making I/O card settings .....	28
Notes about media .....	8	Settings for IF-MA64/EX	
Precautions for use .....	8	and IF-MA64/BN cards .....	29
Note about formatting .....	8	Timecode synchronized recording .....	29
Using the TEAC Global Site .....	8	Recording duration .....	29
User registration .....	8		
<b>2 – Names and Functions of Parts .....</b>	<b>9</b>	<b>5 – Working with Folders (BROWSE screen)..30</b>	
Front panel .....	9	Opening the BROWSE screen .....	30
Rear panel .....	11	Navigating the BROWSE screen .....	30
Note about the PARALLEL connector .....	12	Icons on the BROWSE screen .....	30
Home Screen .....	12	Folder operations .....	30
Menu structure .....	14	Take and file operations .....	31
Basic Menu Screen operations .....	16	Editing folder, take and file names .....	31
Menu operation procedures .....	16	Deleting folders, takes and files .....	32
		Copying folders, takes and files .....	32
		Rebuilding folders .....	33
		Editing the start timecode of a take .....	33
		Creating new folders .....	33
		Folder structure overview .....	34
		Folder structure .....	34
		File name .....	34
		File formats .....	34
<b>3 – Preparation.....</b>	<b>17</b>	<b>6 – Playback.....</b>	<b>35</b>
Installing an SSD/HDD drive in the case .....	17	Files that can be played back .....	35
Loading and removing SSD/HDD cases .....	17	Basic playback operations .....	35
Loading an SSD/HDD case .....	17	Playing recordings .....	35
Removing an SSD/HDD case .....	17	Selecting takes .....	35
Using the security screw .....	17	Skipping to the previous/next take .....	35
Connecting and disconnecting USB flash drives ..	18	Selecting takes directly .....	35
Installing I/O cards (sold separately) .....	18	Searching backward and forward .....	35
Turning the unit on and off (putting it in standby) ..	18	Setting the play mode .....	35
Setting the built-in clock date and time .....	19	Setting the repeat mode .....	35
Adjusting the brightness .....	19		
Preparing SSD/HDD drives and USB flash drives		<b>7 – Internal Settings .....</b>	<b>36</b>
for use .....	19	Setting the timecode .....	36
Connecting headphones .....	20	TC SETUP 1 page settings .....	36
Setting headphones monitoring mode .....	20	TC SETUP 2 page settings .....	37
Setting the lock function .....	21	PARALLEL connector settings .....	38
		PARALLEL INPUT page settings .....	38
		PARALLEL OUTPUT page settings .....	38
		Network function settings .....	39
		Setting the SNTP function .....	40
		Network functions (FTP server/telnet/VNC) .....	42
<b>4 – Recording .....</b>	<b>22</b>		
Restrictions on recording operations .....	22		
Setting the master clock .....	22		
Making word/video connector settings .....	23		
Setting the reference level .....	23		
Setting input monitoring .....	23		
Setting input monitoring for specific channels	24		
Making recording channel settings .....	24		
Setting the record function			
for specific channels .....	24		
Setting the recording file format .....	25		

# Contents

FTP (file transfer protocol) server .....	42	Dimensional drawings .....	59
Remote control (Telnet) .....	43	Block diagrams.....	59
VNC (virtual network computing).....	44	<b>14 – Important notice regarding software ..60</b>	
Making oscillator settings.....	44	Open Source License Term .....	60
<b>8 – Mark and Locate Functions .....</b>	<b>45</b>		
Mark functions .....	45		
Adding marks .....	45		
Using marks.....	45		
Moving to marks .....	45		
Editing mark names.....	46		
Deleting marks.....	46		
Deleting all marks in the current take .....	46		
Editing mark locations.....	46		
Viewing mark information.....	46		
Locating to a specific time.....	47		
Locating before completely specifying the time .....	47		
<b>9 – Loading Files Recorded by Other Devices .....</b>	<b>48</b>		
Preparation before loading.....	48		
Using the loaded files on the unit.....	48		
<b>10 – Data Transfer Using a Computer.....</b>	<b>49</b>		
Computer system requirements .....	49		
Connecting an SSD/HDD to a computer .....	49		
Disconnecting from a computer .....	50		
<b>11 – Other Settings, Information Screens and Keyboard Operations.....</b>	<b>51</b>		
INFO button and indicator appearance.....	51		
Checking the firmware version.....	51		
Firmware update procedures .....	52		
Viewing media information .....	52		
Setting peak hold time .....	53		
Setting the meter mode.....	53		
Using a USB keyboard to operate the unit.....	53		
Setting the keyboard type.....	53		
Using the keyboard to input names and values.....	53		
List of keyboard operations.....	54		
Setting the power redundancy check function (DA-6400dp only) .....	55		
Exporting/importing system backup data.....	55		
Restoring factory default settings .....	56		
<b>12 – Troubleshooting.....</b>	<b>57</b>		
<b>13 – Specifications .....</b>	<b>58</b>		
General .....	58		
Analog output.....	58		
Control input/output.....	58		
Other.....	58		



# 1 – Introduction

Thank you very much for purchasing a TASCAM DA-6400/DA-6400dp Digital Multitrack Recorder.

Before connecting and using this unit, please take time to read this manual thoroughly to ensure you understand how to properly set it up and connect it, as well as the operation of its many useful and convenient functions. After you have finished reading this manual, please keep it in a safe place for future reference.

## Features

- Digital multitrack recorder for professional applications that supports recording/playback of up to 64 channels at 44.1/48kHz 24-bit resolution and 32 channels at 88.2/96kHz 24-bit resolution.
- 1U rackmount size
- Color display (320×120 pixels) built-in
- The 2.5-inch SSDs that are used as recording media provide excellent vibration and environmental resistance as well as maintenance-free operation. Front panel slot design enables quick drive loading and unloading
- AC power redundancy built in (DA-6400dp only)
- With card slots, I/O cards (sold separately) can be used for flexible input and output options
- Equipped with three-pronged inlet power cable
- Video reference (NTSC/PAL blackburst and HDTV tri-level signals) and word clock input and output/thru
- LAN (Gigabit Ethernet) function built-in, allowing file transfer, remote control and monitoring over a network
- Parallel remote control supported
- RS-422 serial remote control supported (9-pin serial protocol compliant)
- Firmware can be updated using a USB flash drive

## Included items

This product includes the following items.

Keep the box and packing materials for transportation in the future.

Please contact TASCAM Customer Support (see back cover) if any of these items are missing or have been damaged during transportation.

- Main unit .....× 1
- Power cord (DA-6400).....× 1
- Power cord (DA-6400dp) .....× 2
- AK-CC25 (SSD/HDD case) .....× 1
- TASCAM TSSD .....× 1
- USB 3.0-compatible cable (with auxiliary power connector) .....× 1
- Rackmount screw kit.....× 1
- Security screw kit .....× 1
- Owner's Manual (this document) including warranty.....× 1

## Conventions used in this manual

In this manual, we use the following conventions:

- When we refer to buttons, connectors and other parts of this unit, we use a bold font like this: **MENU** button.
- When we show messages, for example, that appear on the unit's display, the typeface looks like this: **BROWSE**.
- The area of the display that is shown in inverse (light on dark) is referred to as the cursor or as being highlighted.
- "USB flash drives" are sometimes called "USB drives".
- The set of audio files (up to 64) recorded by this unit at a single time are called a "take".
- Files that can be played back by this unit are sometimes called "music files".
- The device that is currently selected is called the "current device".
- The folder that is currently selected is called the "current folder".
- The take that is currently loaded is called the "current take".
- As necessary, additional information is provided under TIP, NOTE and CAUTION headings.

### TIP

*These are tips about how to use the unit.*

### NOTE

*These provide additional explanations and describe special cases.*

### CAUTION

*Failure to follow these instructions could result in injury, damage to equipment or lost recording data, for example.*

## Trademarks

- TASCAM is a registered trademark of TEAC Corporation.
- This product contains the eT-Kernel RTOS-based software platform of eSOL Co.,Ltd..
- Other company names, product names and logos in this document are the trademarks or registered trademarks of their respective owners.

**Information is given about products in this manual only for the purpose of example and does not indicate any guarantees against infringements of third-party intellectual property rights and other rights related to them. TEAC Corporation will bear no responsibility for infringements on third-party intellectual property rights or their occurrence because of the use of these products.**

**With the exception of personal enjoyment and similar uses, copyrighted materials belonging to third parties cannot be used without permission from the rights holders in accordance with copyright law. Please use the equipment appropriately. TEAC Corporation will bear no responsibility for rights infringements committed by users of this product.**

# 1 – Introduction

## Precautions for placement and use

- The operating temperature range of this unit is 0–40 °C.
- Do not install this unit in the following types of locations. Doing so could make the sound quality worse or cause malfunction.
  - Locations with frequent vibrations
  - Near windows or other places exposed to direct sunlight
  - Near heaters or other extremely hot places
  - Extremely cold places
  - Very humid or poorly ventilated places
  - Very dusty places
- Install the unit so that it is level.
- To enable good heat dissipation, do not place anything on top of the unit.
- Do not place the unit on top of a power amplifier or other device that generates heat.
- Do not allow anything to block the fan and prevent the dispersion of heat.
- To mount this unit in a rack, use the included rackmount screw kit and mount it as shown in the illustration below. Leave at least 1U of space open above it in the rack.

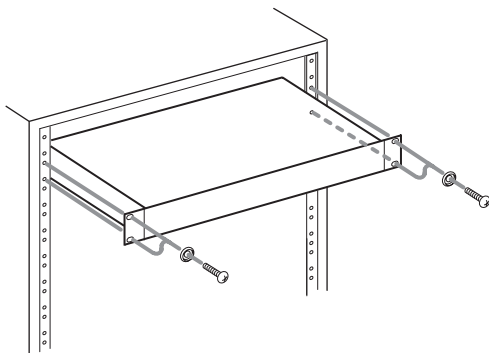

## Notes about power supplies

- Insert the included power cord all the way into the AC IN connector.
- Do not connect a power supply other than one that is AC100V (50-60Hz).
- Hold the power cord by its plug when connecting or disconnecting it.
- When connecting a second redundant power supply, the two supplies should be drawing power from separate lines that do not affect each other.

## Beware of condensation

Condensation could occur if the unit is moved from a cold place to a warm place, it is used immediately after a cold room has been heated or it is otherwise exposed to a sudden temperature change. To prevent this, or if this occurs, let the unit sit for one or two hours at the new room temperature before using it.

## Cleaning the unit

Use a dry soft cloth to wipe the unit clean. Do not wipe with chemical cleaning cloths, thinner, alcohol or other chemical

agents. Doing so could damage the surface or cause discoloration.

## Notes about SSD and HDD drives

### Notes about media

This unit can use SSDs and HDDs for recording and playback. An SSD that has been confirmed to operate with this unit is included in the package.

Please use this SSD model, which is also available for separate purchase from TASCAM.

Check the TEAC Global Site (<http://teac-global.com/>) for information about other media. Please check this site or contact TASCAM customer support. (<http://teac-global.com/>)

### Precautions for use

SSD and HDD drives are delicate media. In order to avoid damaging SSD and HDD drives, please take the following precautions when handling them.

- Do not leave them in extremely hot or cold places.
- Do not leave them in extremely humid places.
- Do not let them get wet.
- Do not put things on top of them or twist them.
- Do not hit them.
- Do not remove or insert a drive during recording, playback, data transmission or other access.
- When transporting a drive, put it into a case, for example.

### Note about formatting

SSD and HDD drives formatted by this unit are optimized to improve performance during recording. Use this unit to format SSD and HDD drives to be used with it. Errors might occur when recording with this unit using an SSD/HDD formatted by a computer or other device.

## Using the TEAC Global Site

You can download the Owner's Manual necessary for this unit from the TEAC Global Site (<http://teac-global.com/>).

1. Open the TEAC Global Site (<http://teac-global.com/>).
2. In the TASCAM Downloads section, click the desired language to open the Downloads website page for that language.

### NOTE

*If the desired language does not appear, click Other Languages.*

3. Click the product name in the "Search by Model Name" section to open the Downloads page for that product.
4. Select and download the Owner's Manual that are needed.

## User registration

Customers in the USA, please visit the TASCAM website (<http://tascam.com/>) to register as a user online.



# 2 – Names and Functions of Parts

## Front panel

### ■ DA-6400 front panel

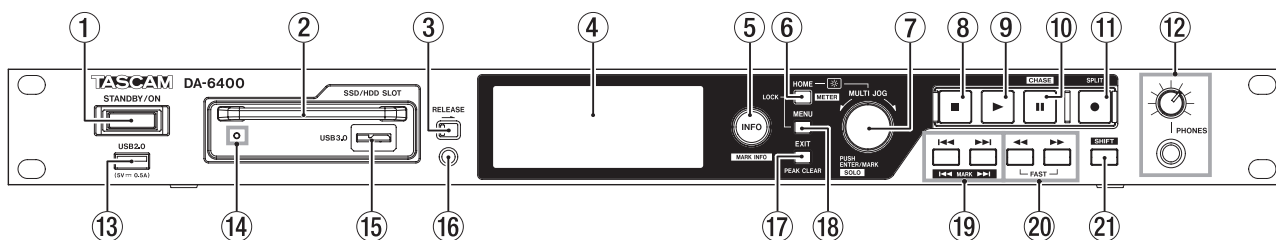

### ■ DA-6400dp front panel

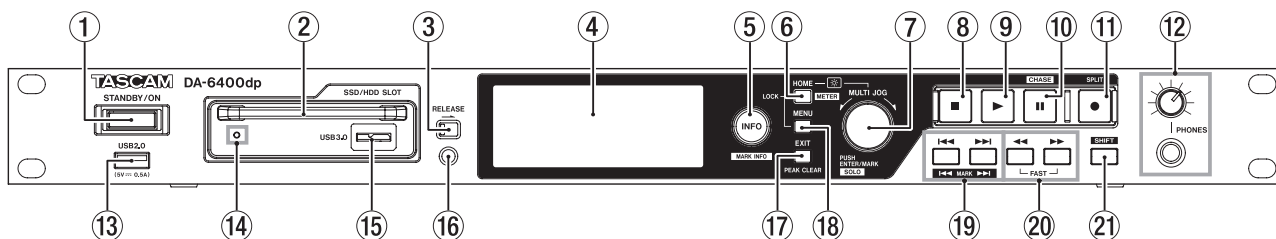

#### ① STANDBY/ON switch

Use to turn the unit on and to put it into standby.

Press and hold it when the power is on to open a pop-up message confirming that you want to put the unit into standby.

When the pop-up is open, press and hold the **MULTI JOG** dial to put the unit into standby.

#### CAUTION

*Before turning the unit on, lower the volumes of connected equipment to their minimum levels. Failure to do so could result in a sudden loud noise that could harm hearing, for example.*

#### ② SSD/HDD SLOT

Use this bay to insert and remove SSD/HDD cases. (See "Loading and removing SSD/HDD cases" on page 17.)

#### CAUTION

*Do not remove the SSD/HDD case from the unit when the SSD/HDD is being accessed (during recording, playback, when data is being written or at other times when the SSD/HDD case indicator is blinking orange).*

#### ③ RELEASE switch

Slide the **RELEASE** switch toward  $\rightarrow$  to unlock the loaded SSD/HDD case so that it can be removed.

#### ④ Color display

Shows a variety of information.

#### ⑤ INFO button and indicator

The **INFO** indicator lights blue when the unit is functioning properly.

The **INFO** indicator lights red when an error or warning has occurred with the unit.

Press this button when the **INFO** indicator is lit blue to show the unit's operation status on the display. Press this button when the **INFO** indicator is lit red to show the message on the display. (See "INFO button and indicator appearance" on page 51.)

Press this button while pressing and holding the **SHIFT** button to open the **MARK INFO** screen. (See "Using marks" on page 45.)

#### ⑥ HOME [METER] button

- Press when the Home Screen is open to change the time display mode.

- When a Menu Screen is open, press this button to return to the Home Screen.

- While pressing and holding this button, turn the **MULTI JOG** dial to adjust the brightness of the color display and the various indicators. (See "Adjusting the brightness" on page 19.)

- While pressing and holding this button, press and turn the **MULTI JOG** dial to adjust the brightness of just the color display. (See "Adjusting the brightness" on page 19.)

- When the meter mode setting is 32ch, press this button while pressing and holding the **SHIFT** button to switch between showing level meters for channels 1-32 and 33-64 on the Home Screen. (See "Setting the meter mode" on page 53.)

#### ⑦ MULTI JOG dial

This dial functions both as a dial when turned and as a button when pressed.

##### Dial functions

- When the white solo selection frame is shown on the Home Screen, turn the **MULTI JOG** dial to move the solo selection frame for headphone output left and right to select the channel(s) output from the **PHONES** jack.

- When the gray solo selection frame is shown on the Home Screen, turn the **MULTI JOG** dial to move between marks in the current take. When there are no marks, turn to skip between takes.

- When a Menu Screen is open, turn to select items and change setting values.

- When editing names, use to select characters.

- While pressing and holding the **HOME [METER]** button, turn the **MULTI JOG** dial to adjust the brightness of the color display and the various indicators.

- While pressing and holding the **HOME [METER]** button, press and turn this dial to adjust the brightness of just the color display.

## 2 – Names and Functions of Parts

- When the **BROWSE** screen is open, turn this to select folders. (See “Navigating the BROWSE screen” on page 30.)

### Button functions

- When the Home Screen is open and the unit is stopped, recording, in recording standby, playing back or in playback standby, press this button to add a mark. (See “Mark functions” on page 45.)
  - When the Home Screen is open, press the **MULTI JOG** dial while pressing and holding the **SHIFT** button to switch the solo selection frame color.
  - When the Home Screen is open, press and hold the **MULTI JOG** dial while pressing and holding the **SHIFT** button to switch the headphone monitoring mode between STEREO and MONO. (See “Setting headphones monitoring mode” on page 20.)
  - When a Menu Screen is open, press to confirm selections and settings (**ENTER** button function).
  - When the **BROWSE** screen is open, press this to show the pop-up folder/file menu for the selected folder/file. (See “Folder operations” on page 30.) (See “Take and file operations” on page 31.)
  - When the **BROWSE** screen or a Menu Screen is open, turn the **MULTI JOG** dial while pressing and holding the **SHIFT** button to make rough setting changes (**MOVE** Fast operation).
- ⑧ **■ button**  
Press to stop playback or recording.
- ⑨ **▶ button and indicator**  
Press when stopped or playback ready to start playback.  
Press when in recording standby to start recording.  
This button lights during playback and recording.
- ⑩ **II [CHASE] button and indicator**  
Press when stopped or playing back to start playback standby.  
Press when recording to start recording standby.  
This button lights when in playback or recording standby.
- ⑪ **● [SPLIT] button and indicator**  
Press when stopped to start recording standby.  
This button lights when recording or in recording standby.  
Press when recording to stop recording to the current take and start recording to a new take without pausing.
- ⑫ **PHONES jack and knob**  
Use this standard stereo jack to connect stereo headphones.  
Use an adapter to connect headphones with a mini plug.  
Use the **PHONES** knob to adjust the headphone output level.

### CAUTION

*Before connecting headphones, minimize the volume with the **PHONES** knob. Failure to do so might cause sudden loud noises, which could harm your hearing or result in other trouble.*

- ⑬ **USB2.0 port**  
Connect (and disconnect) USB flash drives here. (See “Connecting and disconnecting USB flash drives” on page 18.)

When a USB flash drive is connected, files can be copied between it and the SSD/HDD drive. In addition, you can also connect a USB keyboard here, and use it to input characters for folder and file names, for example as well as for external control. By default, the unit is set to use a Japanese keyboard. Since English and Japanese keyboards use different layouts, you should change the setting on the **KEYBOARD TYPE** screen if you are using an English keyboard. (See “Setting the keyboard type” on page 53.)

- ⑭ **SSD/HDD slot power/access indicator**  
This lights blue when powered and the SSD/HDD is not being accessed.  
The **SSD/HDD slot indicator** blinks orange when the drive is being accessed.
- ⑮ **SSD/HDD slot USB 3.0 port**  
Use the included USB cable to connect the unit to a computer.  
Use this port when exchanging data between a computer and the SSD/HDD drive.  
When connected to a USB 2.0 port, only USB 2.0 transfer speeds are supported.

- ⑯ **Security screw hole**  
You can use the included security screw kit to lock the **RELEASE** switch. (See “Using the security screw” on page 17.)
- ⑰ **EXIT [PEAK CLEAR] button**  
When a setting screen is open, press this button to go back one step in the menu.  
Press this button to answer “NO” to a confirmation pop-up message.  
When the Home Screen is open, press this button to clear level meter peak holds.

- ⑱ **MENU button**  
When the Home Screen is open, press this button to open the Menu Screen. (See “Menu structure” on page 14.) and (See “Basic Menu Screen operations” on page 16.)

- ⑲ **◀◀/▶▶ [MARK ◀◀/▶▶] buttons**  
Press these buttons to skip to the previous/next take.  
Press these buttons while pressing and holding the **SHIFT** button to move to the previous/next mark.

- ⑳ **◀◀/▶▶ buttons**  
Press and hold these buttons to search backward/forward.  
When searching one way, press and hold the button for the opposite direction (◀◀ or ▶▶) to search at high speed.

## 2 – Names and Functions of Parts

### ⑳ **SHIFT button**

- When the Home Screen is open, press the **MULTI JOG** dial while pressing and holding this button to show a white frame in the meter section, and turn the **MULTI JOG** dial to select the audio channel to be output from the **PHONES** jack.
- When the Home Screen is open, press and hold the **MULTI JOG** dial while pressing and holding the **SHIFT** button to switch the headphone monitoring mode between STEREO and MONO. (See “Setting headphones monitoring mode” on page 20.)
- When the meter mode setting is 32ch, press the **HOME [METER]** button while pressing and holding this button to switch between showing level meters for channels 1-32 and 33-64 on the Home Screen. (See “Setting the meter mode” on page 53.)
- Press the **INFO** button while pressing and holding this button to open the **MARK INFO** page.
- Press the **MENU** button while pressing and holding this button to open the menu pages in the opposite direction.
- When an audio output channel is selected on the Home Screen, when a channel is selected for setting changes on the **REC FUNCTION** or **INPUT MONITOR** screen, or when a folder is selected on the **BROWSE** screen, turn the **MULTI JOG** dial while pressing and holding this button to move the cursor by large amounts. When stopped, in playback standby or playing back.
- Press this button while pressing and holding the **◀◀ [MARK ◀◀]** button to move to the previous mark and resume the previous state.
- Press this button while pressing and holding the **▶▶ [MARK ▶▶]** button to move to the next mark and resume the previous state.

## Rear panel

### ■ DA-6400 rear panel

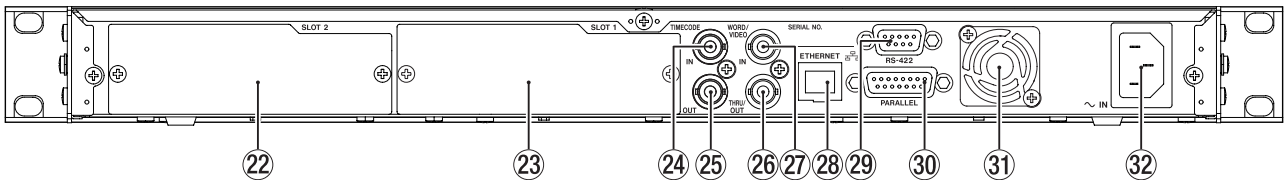

### ■ DA-6400dp rear panel

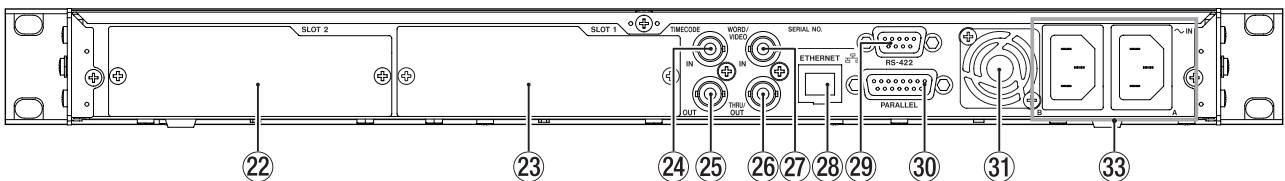

### ⑳ **SLOT 2**

Use this slot to install an I/O card (sold separately).

### ㉑ **SLOT 1**

Use this slot to install an I/O card (sold separately).

### ㉒ **TIMECODE IN connector**

This BNC connector is for the input of SMPTE timecode.

### ㉓ **TIMECODE OUT connector**

This BNC connector is for the output of SMPTE timecode.

### ㉔ **WORD/VIDEO THRU/OUT connector**

This BNC connector is for the output of word clock and video reference signals.

This connector outputs word clock signals (thru or 44.1, 48, 88.2 or 96 kHz) and video reference signals (signal thru from IN jack).

### ㉕ **WORD/VIDEO IN connector**

This BNC connector is for the input of word clock and video reference signals. Use this connector to input word clock signals (44.1, 48, 88.2 or 96 kHz) and video reference signals (NTSC/PAL blackburst and HDTV tri-level).

### ㉖ **ETHERNET connector**

This is an Ethernet port. Use this to connect to a network, transfer files and control the unit externally.

### ㉗ **RS-422 terminal**

This is a 9-pin D-sub RS-422 serial control terminal. Connect an external controller here.

### ㉘ **PARALLEL connector**

This is a 15-pin D-sub parallel control terminal. Connect an external controller here.

### ㉙ **Heat dissipation fan**

This fan is to prevent the unit from overheating. Do not allow anything to block the fan and prevent the dispersion of heat.

### ㉚ **AC IN connector (DA-6400 only)**

Plug the included power cord in here.

### ㉛ **AC IN A/B connectors (DA-6400dp only)**

Plug the included power cords in here.

To operate the unit with power supply redundancy, connect power supplies to both the **AC IN A** and **AC IN B** connectors.

## 2 – Names and Functions of Parts

### Note about the PARALLEL connector

The **PARALLEL** connector on the back of the unit allows external control of it.

You can set the functions of the **PARALLEL** connector on the **PARALLEL INPUT** and **PARALLEL OUTPUT** pages. (See "PARALLEL connector settings" on page 38.)

The factory default pin assignments are as follows.

Pin No.	I/O	Function (default value)
1	O	OUTPUT AUX1 (STOP TALLY)
2	O	OUTPUT AUX2 (REC TALLY)
3	I	INPUT AUX1 (TAKE SKIP +)
4	I	INPUT AUX2 (TAKE SKIP -)
5	O	OUTPUT AUX3 (ERROR TALLY)
6	I	INPUT AUX3 (FADER REC)
7	I	INPUT AUX4 (REW)
8		GND
9	O	OUTPUT AUX4 (PLAY TALLY)
10	O	OUTPUT AUX5 (PAUSE TALLY)
11	I	INPUT AUX5 (F.FWD)
12	I	STOP
13	I	PLAY
14	I	INPUT AUX6 (PAUSE)
15		+5V

I: For command input and transport control

Internal circuit with +5V pull-up

Operates with low signal input of 50 msec or longer

When INPUT AUX is set to FADER REC, low signal input starts recording and high signal input stops recording.

When INPUT AUX is set to FADER START, low signal input starts playback and high signal input pauses playback.

O: For command and tally output

Internal circuit is open collector (10Ω output impedance)

Outputs low command during operation

20V dielectric strength, 35mA maximum current

+5V: 50mA maximum supplied current

The following example is of a connection that controls recording and playback of this unit by level, using fader starts and stops and FADER REC commands.

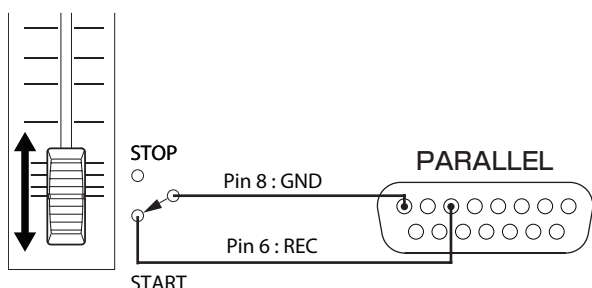

#### NOTE

Setting multiple FADER REC and FADER START settings to INPUT AUX is not possible.

### Home Screen

The following information is shown on the unit's display.

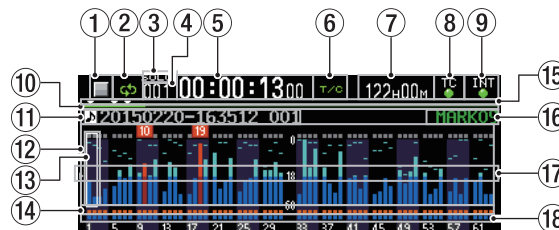

#### ① Transport status

This icon shows the current transport status.

Icon	Meaning
	Playing back
	In playback standby
	Stopped
	Searching backward
	Searching forward
	Searching backward (high speed)
	Searching forward (high speed)
	Recording
	In record standby

#### ② Repeat status

	When repeat playback is off, the  icon is unlit.
	When repeat playback is on, the  icon is lit.

#### ③ Solo status

When the solo selection frame is white, the **SOLO** icon blinks.

#### ④ Take number

This shows the number of the take playing or being recorded.

#### ⑤ Time counter

This shows the elapsed recording/playback time of the take or the timecode time.

#### ⑥ Time display mode

This icon shows the current time display mode.

Time display mode	Meaning
	This shows the elapsed time from the beginning of the take.
	This shows the remaining time until the end of take. When recording, this shows the remaining time until the maximum file size is reached.
	This shows the total take elapsed time.
	During playback, this shows the total take remaining time. When recording, this shows the remaining available recording time.
	This shows the timecode time of the recording/playback take.

## 2 – Names and Functions of Parts

### ⑦ Remaining media capacity

This shows the remaining available recording time of the current media.

No Media is shown when no SSD/HDD drive is loaded.

UNFORMAT is shown if the loaded SSD/HDD drive has not been formatted.

Rec Limit is shown if recording is not possible because the total number of folders, takes inside folders and other files would exceed the system limit.

### ⑧ Timecode status

When the TC GENERATOR MODE screen is not set to TC SYNC REC.

	The TC indicator lights green when correct timecode is being input and recognized properly.
	The indicator does not light when input timecode recognition is abnormal.

When the TC GENERATOR MODE screen is set to TC SYNC REC.

	The TC indicator lights red when correct timecode is being input and recognized properly.
	The indicator flashes red when input timecode recognition is abnormal.

### ⑨ Audio synchronization status

The name of the currently selected master clock is shown with the indicator. (See “Setting the master clock” on page 22.)

	When synchronized with the master clock, the indicator lights green.
	When not synchronized with the master clock, the indicator blinks.

### ⑩ Time bar

This shows the current playback position. What is shown depends on the time display mode.

Time display mode	Meaning	Bar display
	The current playback position is shown relative to the length of the take.	Lengthens from the left end toward the right end.
		Shortens from the left end toward the right end.
	The current playback position is shown relative to the length of all takes in the folder.	Lengthens from the left end toward the right end.
	(Vertical white lines show divisions between takes.)	Shortens from the left end toward the right end.
	The current playback position is shown relative to the length of the take.	Lengthens from the left end toward the right end.

#### NOTE

*During recording, a progress bar appears to extend from the left end to the right end about every 10 seconds.*

### ⑪ Take name

This shows the name of the currently loaded take.

### ⑫ Level meter display area

This area shows the levels of the input and playback signals.

When a level overloads, the bar meter becomes red and the channel number appears in a pop-up above it.

### ⑬ Solo selection frame

The level meter for the channel currently output from the PHONES jack is shown with a white or gray frame. When the selection frame appears white, turn the MULTI JOG dial to select the channel output from the PHONES jack.

Press the MULTI JOG dial while pressing and holding the SHIFT button to switch the headphone output solo selection frame to white/gray.

When the PHONES MONITOR MODE screen setting is MONO, the solo selection frame will be for a mono channel. (See “Setting headphones monitoring mode” on page 20.)

### ⑭ Record function indicators

These show whether recording is enabled or not for each channel.

Recording enabled: Red

Recording disabled: Gray

### ⑮ Marks

An ▼ icon is shown at each mark.

### ⑯ Mark name

This shows the name of the mark at or immediately before the current time.

### ⑰ Level meter guide

This level meter guide can be used to evaluate input and output levels.

This line is shown at –18 dB.

The position of the guide and the value (▶ 18 ◀) shown depend on the value set on the REFERENCE LEVEL screen. (See “Setting the reference level” on page 23.)

### ⑱ Input monitoring indicator area

These show whether input monitoring is enabled or not for each channel.

Input monitoring on: Blue

Input monitoring off: Unlit

#### NOTE

*When the sampling frequency is 88.2/96 kHz, the following data in the area for channels 33–64 is not shown.*

- Level meters
- Record function indicators
- Input monitoring indicators

*Furthermore, the solo selection frame cannot be moved to channels 33–64.*



## 2 – Names and Functions of Parts

### Menu structure

Press the **MENU** button to open the **GENERAL** page of the menu the first time. In the future, pressing this button will reopen the menu page that was last open.

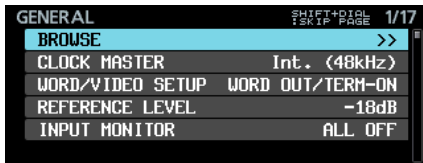

The MENU screen has 17 pages organized by types of menu items.

	Page name	Contents
1	GENERAL	Make settings for general functions.
2	REC FILE FORMAT	Make recording file format settings.
3	REC OPTIONS	Make recording option settings.
4	PLAY SETUP	Make playback settings.
5	INPUT ROUTING 1	Make input routing settings.
6	INPUT ROUTING 2	
7	SLOT 1	Make settings for SLOT 1.
8	SLOT 2	Make settings for SLOT 2.
9	TC SETUP 1	Make settings related to timecode.
10	TC SETUP 2	
11	PARALLEL INPUT	Make input settings for the PARALLEL connector.
12	PARALLEL OUTPUT	Make output settings for the PARALLEL connector.
13	NETWORK	Make network settings.
14	SNTP	Make SNTP settings.
15	MEDIA	Work with media.
16	PREFERENCES	Make preference settings.
17	SYSTEM SETUP	Make system settings.

The various menu items are as follows.

Menu item	Function	Page
GENERAL page		
BROWSE	Open BROWSE screen	page 30
CLOCK MASTER	Set the master clock	page 22
WORD/VIDEO SETUP	Make word/video connector settings	page 23
REFERENCE LEVEL	Set the reference level	page 23
INPUT MONITOR	Set input monitoring function	page 23
REC FILE FORMAT page		
REC FUNCTION	Make recording channel settings	page 24
BIT LENGTH	Set the bit length	page 25
REC Fs	Set the sampling frequency	
FILE NAME	Set the file name format	page 26
REC OPTIONS page		
AUTO FILE INCREMENT	Make automatic take function settings	page 27
AUTO MARK	Make automatic mark function settings	page 27
PAUSE MODE	Make pause mode function settings	page 28
PLAY SETUP page		
PLAY MODE	Set the playback mode	page 35
REPEAT MODE	Set the repeat mode	page 35
INPUT ROUTING 1 page		
CHANNEL 1-8	Make input routing settings	page 28
CHANNEL 9-16		
CHANNEL 17-24		
CHANNEL 25-32		
INPUT ROUTING 2 page		
CHANNEL 33-40	Make input routing settings	page 28
CHANNEL 41-48		
CHANNEL 49-56		
CHANNEL 57-64		
SLOT 1 page		
Set various functions for the card loaded in SLOT 1		page 28
SLOT 2 page		
Set various functions for the card loaded in SLOT 2		page 28
TC SETUP 1 page		
GENERATOR TC	Set the timecode for the timecode generator	page 36
GENERATOR U.B.	Set the user bits (U.B.) for the timecode generator	
TC INPUT MONITOR	View the input timecode time	
TC INPUT FRAME	View the input timecode frame type	
TC INPUT U.B.	View the user bits (U.B.) for the input timecode	
START TIME	Set the time when timecode resumes	
TC SETUP 2 page		
TC GENERATOR MODE	Set the mode for the timecode generator	page 37
TC FRAME TYPE	Set the timecode frame type	
TC OUTPUT MODE	Set the timecode output mode	



## 2 – Names and Functions of Parts

Menu item	Function	Page
PARALLEL INPUT page		
INPUT AUX1	Set the input function for the PARALLEL connector	page 38
INPUT AUX2		
INPUT AUX3		
INPUT AUX4		
INPUT AUX5		
INPUT AUX6		
PARALLEL OUTPUT page		
OUTPUT AUX1	Set the output function for the PARALLEL connector	page 38
OUTPUT AUX2		
OUTPUT AUX3		
OUTPUT AUX4		
OUTPUT AUX5		
EOM	Set the EOM function	
NETWORK page		
MAC ADDRESS	View the unit's MAC address	page 39
IP ADDRESS	View the current IP address	
DNS ADDRESS	View the IP address of the DNS server	
IP SETUP	Set the unit's IP address and related settings	
DNS SETUP	Set the IP address of the DNS server	
PASSWORD	Set the password	
SNTP page		
SNTP STATUS	View the SNTP function status	page 40
SNTP UPDATE	Set the SNTP update mode	
NTP SERVER	Set the NTP server name	
UPDATE TIME	Set the time to the time acquired from the NTP server	
TIME ZONE	Set the time offset from Coordinated Universal Time (UTC)	
DST SETUP	Set the daylight savings time function	
MEDIA page		
QUICK FORMAT	Quickly format media	page 19
FULL FORMAT	Format media completely	
MEDIA INFO	Show media information	page 52
SSD/HDD USB CONNECT	Connecting an SSD/HDD to a computer	page 49
PREFERENCES page		
PHONES MONITOR MODE	Set headphones monitoring mode	page 20
PEAK HOLD TIME	Set the level meter peak hold time	page 53
METER MODE	Set the number of level meter channels shown	page 53
KEYBOARD TYPE	Set the keyboard type	page 53
POWER REDUNDANCY CHECK	Set the power supply redundancy check function	page 55
SYSTEM SETUP page		
SYSTEM BACKUP	Export/import system backup data	page 55
FACTORY PRESET	Restore factory default settings	page 56
OSCILLATOR	Make oscillator settings	page 44
CLOCK ADJUST	Set the built-in clock date and time	page 19

Menu item	Function	Page
VERSION INFO	Show system version information	page 51
F/W UPDATE	Update the firmware	page 52

### NOTE

*The settings for all menu items, except the oscillator on/off setting, are retained even when the unit is turned off.*

## 2 – Names and Functions of Parts

### Basic Menu Screen operations

Use the following operations to work with the pages of the Menu Screen.

#### ■ Changing menu items by page:

Press the **MENU** button repeatedly until the desired menu page opens.

The pages will open in the following order.

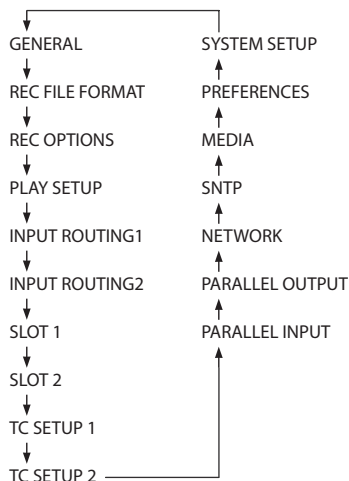

#### NOTE

- Press the **MENU** button while pressing and holding the **SHIFT** button to open menu pages in the opposite direction.
- Turn the **MULTI JOG** dial to move up or down one item at a time from the **GENERAL** page **BROWSE** item to the **SYSTEM SETUP** page **F/W UPDATE** item.
- Turn the **MULTI JOG** dial while pressing and holding the **SHIFT** button to move up or down one menu page at a time.

#### ■ Selecting items (moving vertically on a page):

Turn the **MULTI JOG** dial.

#### ■ Confirming a selected item:

Press the **MULTI JOG** dial.

#### ■ Opening a submenu from a page:

Press the **MULTI JOG** dial.

#### ■ Going back one step in a menu:

Press the **EXIT [PEAK CLEAR]** button.

#### ■ Returning directly to the Home Screen from a menu:

Press the **HOME [METER]** button.

### Menu operation procedures

In this example, we explain how to set the auto mark function.

1. Press the **MENU** button and open the **GENERAL** menu page.

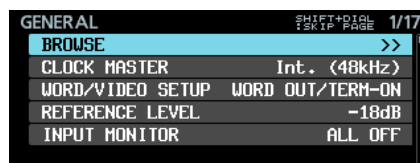

2. Press the **MENU** button to open any other menu page.



REC OPTIONS page open

3. Turn the **MULTI JOG** dial to select the item to set.



AUTO MARK selected

4. Press the **MULTI JOG** dial to open the settings screen.

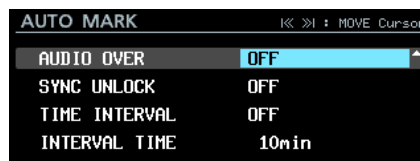

AUTO MARK screen open

5. Turn the **MULTI JOG** dial to change the setting.
6. To set another item on the same screen, press the **MULTI JOG** dial to move the cursor to the next setting. When **MOVE Cursor** appears at the top right of the screen, you can use the **MARK** **MARK** buttons to move the cursor.
7. Repeat steps 5 to 6 as necessary to set other items.
8. On the last item, press the **MULTI JOG** dial to confirm the changed settings and return to the Menu Screen. Press the **HOME [METER]** button to return to the Home Screen.

#### NOTE

- Press the **EXIT [PEAK CLEAR]** button to cancel the menu operation and return to the Menu Screen.
- Menu items that cannot be changed are shown with gray characters and cannot be selected using the **MULTI JOG** dial.

# 3 – Preparation

## Installing an SSD/HDD drive in the case

1. While pressing the cover lock on the left side of the SSD/HDD case handle, slide the lower cover toward the connector and remove it.
2. While pressing the cover lock on the right side of the SSD/HDD case handle, slide the upper cover toward the connector and remove it.
3. Place the SSD/HDD drive in the top of the case, and attach it to the connector at the handle end.
4. Attach the set SSD/HDD drive with screws through the bottom of the case.
5. While pressing the cover lock part of the SSD/HDD case, slide the lower and upper covers from the connector end to attach them.

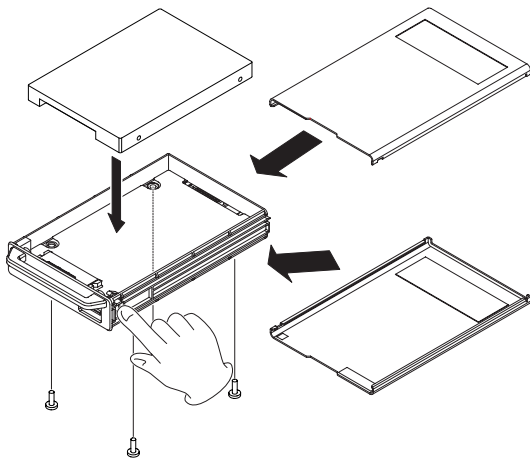

### CAUTION

Be careful not to squeeze parts near the handle when attaching the upper and lower covers.

## Loading and removing SSD/HDD cases

### Loading an SSD/HDD case

Insert the SSD/HDD case into the **SSD/HDD SLOT** on the front of the unit until they are even.

### CAUTION

Before inserting the SSD/HDD case into the main unit, remove the static electricity protection cover from the SSD/HDD case main unit connector.

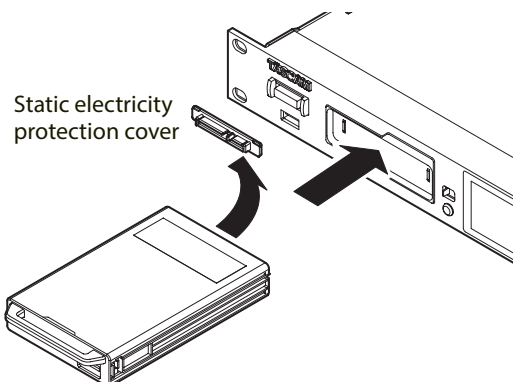

### NOTE

- If you are unable to insert the SSD/HDD case properly, try removing it once and reinserting it.
- You can insert a case even when the unit is on.

### Removing an SSD/HDD case

SSD/HDD cases can be ejected.

### CAUTION

Do not remove the SSD/HDD case from the unit when the SSD/HDD is being accessed (during recording, playback, when data is being written or at other times when the SSD/HDD case indicator is blinking orange). Removing a case when its drive is being accessed could cause proper recording to fail, recorded data to be lost, and sudden loud noises from monitoring equipment, which might damage the equipment or harm hearing.

### NOTE

You can remove the SSD/HDD case from the unit even when the unit is on as long as the SSD/HDD is not being accessed (during recording, playback, when data is being written or at other times when the SSD/HDD case indicator is blinking orange).

1. Slide the **RELEASE** switch toward ➡.

This unlocks the loaded SSD/HDD case so that it can be removed.

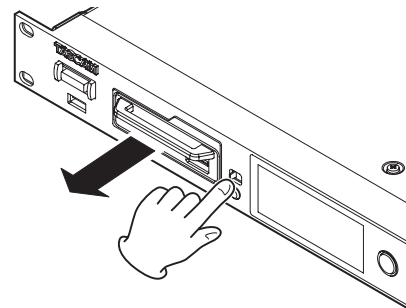

2. While sliding the **RELEASE** switch toward ➡, grasp the SSD/HDD case by hand and pull it out.

### CAUTION

After removing the SSD/HDD case from the main unit, attach the static electricity protection cover to the SSD/HDD case main unit connector.

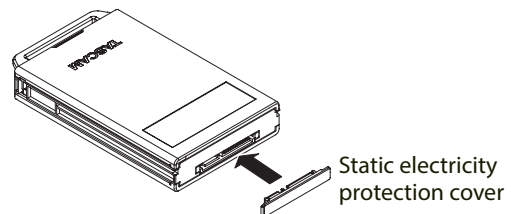

### Using the security screw

You can use the included security screw kit to lock the SSD/HDD case so that cannot be removed.

Use a Phillips (+) driver to install/remove the security screw.

## 3 – Preparation

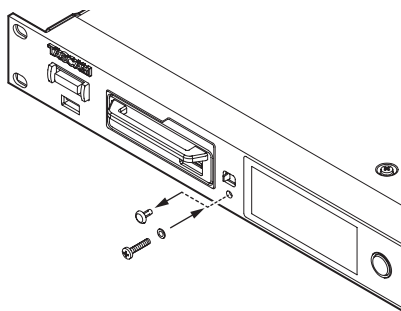

### NOTE

During installation, be careful not to tighten the screw too much.

## Connecting and disconnecting USB flash drives

You can connect and disconnect USB flash drives whether the unit is on or off.

### CAUTION

Do not disconnect a USB flash drive when it is being accessed in one of the following manners.

Doing so could damage data or the USB flash drive.

Moreover, disconnecting the USB flash drive during the execution of a firmware update could result in the unit becoming unable to start up or operate properly.

- During execution of the **FACTORY PRESET** function
- During execution of a **SYSTEM BACKUP IMPORT** or **EXPORT**
- During execution of a firmware update
- When the **BROWSE** screen is open and the USB flash drive is being accessed

## Installing I/O cards (sold separately)

### CAUTION

Before installing or removing an I/O card (sold separately), disconnect the power cord from the outlet or the unit.

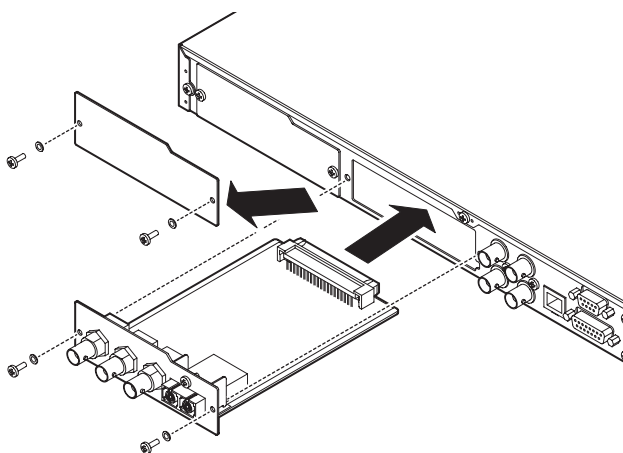

1. Remove the two screws from the plain panel and remove the panel itself. (If a different card is already installed, remove it.)
2. Insert the I/O card into the card slot. Align the edges of the I/O card with the white guides inside the slot and insert it

securely. Push the I/O card in until its backplate reaches the back panel of the unit, leaving no gap, and clicks into place. Do not force the card into the slot. If you cannot insert the card properly, remove it once and try reinserting it.

3. Use the two removed screws to secure the I/O card in place.
4. Turn the unit on, and check the **VERSION INFORMATION** screen to confirm that it has recognized the inserted I/O card. (See “Checking the firmware version” on page 51.)

If “SLOT1 : --- (None)” or something similar appears, the card might not be inserted correctly or the screws might not be tightened securely. Insert the I/O card securely into the unit again.

## Turning the unit on and off (putting it in standby)

When the unit is off, press the **STANDBY/ON** switch on the front of the unit to turn it on.



DA-6400dp startup screen

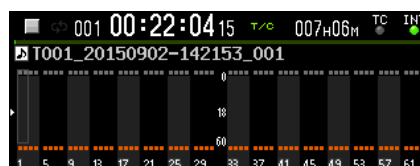

Home Screen

After the unit starts and the startup screen is shown, the Home Screen will open.

If no SSD/HDD is loaded in the slot or there are no audio files in the current folder, the take number and time will not be shown on the Home Screen.

### ■ Turning the unit off:

Press and hold the **STANDBY/ON** switch to open a pop-up message.

When the confirmation pop-up is open, press and hold the **MULTI JOG** dial to turn the unit off.

### CAUTION

- Do not turn the unit off (put it into standby) during recording, playback or at other times when data on the SSD/HDD is being accessed. The SSD/HDD case indicator blinks orange at such times. Doing so could cause proper recording to fail, recorded data to be lost, and sudden loud noises from monitoring equipment, which might damage the equipment or harm hearing.
- When the unit is started up for the first time (or when the built-in clock is reset after being left unused without power for a long time), the **CLOCK ADJUST** screen appears after the start-up screen to allow the date and time of the built-in clock to be set. (See “Setting the built-in clock date and time” on page 19.)

## Setting the built-in clock date and time

Using its internal clock, this unit includes the date and time when a file is recorded.

1. Select the **CLOCK ADJUST** item on the **SYSTEM SETUP** page to open the **CLOCK ADJUST** screen. (See “Menu operation procedures” on page 16.)

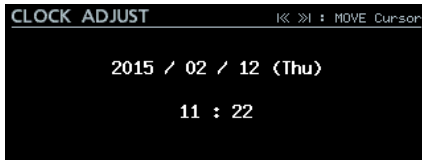

2. Press the **MULTI JOG** dial to enter setting mode and show the cursor on the item to be changed.  
Use the **◀◀/▶▶** [**MARK** **◀◀/▶▶**] buttons to move the cursor.

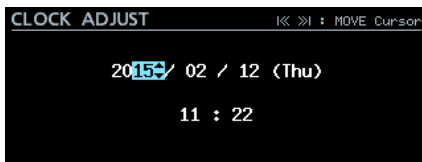

3. Turn the **MULTI JOG** dial to change a value, and press the **MULTI JOG** dial to confirm it and move the cursor to the next item.
4. The cursor will disappear and setting the time of the built-in clock will complete after you change the year, month, day, hour and minute in order.

### NOTE

*When making a setting, you can press the **EXIT [PEAK CLEAR]** button to cancel the changes and return to the Menu Screen.*

5. Press the **EXIT [PEAK CLEAR]** button to return to the Menu Screen.

## Adjusting the brightness

While pressing and holding the **HOME [METER]** button, turn the **MULTI JOG** dial to adjust the brightness of the color display and the indicators.

While pressing and holding the **HOME [METER]** button, press and turn the **MULTI JOG** dial to adjust the brightness of only the color display.



## Preparing SSD/HDD drives and USB flash drives for use

In order to use an SSD/HDD drive or USB flash drive with this unit, you must use this unit to format it first.

### CAUTION

- *Formatting erases all the data on the SSD/HDD drive or USB flash drive. Confirm that this is okay before proceeding.*
  - *Always use this unit to format medias to be used with it. Operation of this unit might be affected when using an SSD/HDD or USB flash drive that has been formatted by a computer or other device.*
1. On the **MEDIA** page, select the **QUICK FORMAT** or **FULL FORMAT** item. (See “Menu operation procedures” on page 16.)

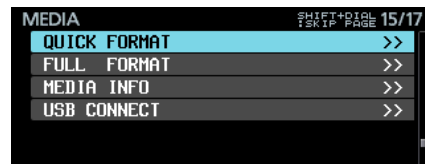

**QUICK FORMAT:** Format only media management data.

**FULL FORMAT:** Completely format the media.

2. When the **QUICK FORMAT** or **FULL FORMAT** screen opens, select the media to format.

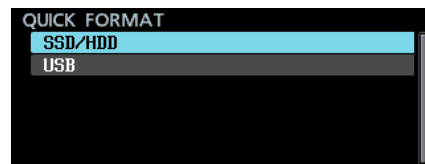

When **QUICK FORMAT** selected

The following pop-up message will appear.

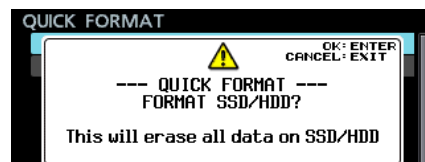

When **QUICK FORMAT** selected

### NOTE

- *Press the **EXIT [PEAK CLEAR]** button to cancel formatting.*
- *If no SSD/HDD drive is loaded, the following pop-up message will appear.*

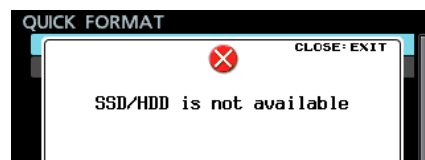

## 3 – Preparation

- Press the **MULTI JOG** dial.  
A second confirmation pop-up message will appear.

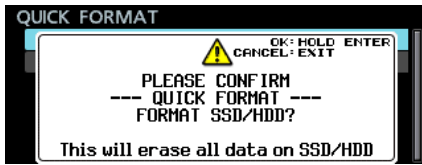

When **QUICK FORMAT** selected

- Press and hold the **MULTI JOG** dial to start formatting.  
The following pop-up message will appear during formatting.

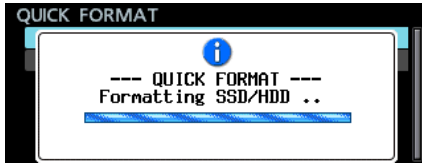

When **QUICK FORMAT** selected

- When formatting ends, the pop-up disappears and the Home Screen opens.

## Connecting headphones

Connect headphones to the **PHONES** jack on the front of the unit.

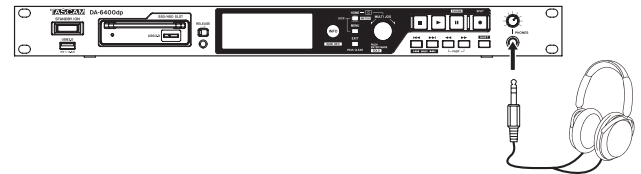

### CAUTION

*Before connecting headphones, minimize the volume with the **PHONES** knob. Failure to do so might cause sudden loud noises, which could harm your hearing or result in other trouble.*

## Setting headphones monitoring mode

The headphones monitoring mode can be set.

- Select the **PHONES MONITOR MODE** item on the **PREFERENCES** page to open the **PHONES MONITOR MODE** screen. (See “Menu operation procedures” on page 16.)



- Set the headphones monitoring mode.  
Options: **STEREO** (default), **MONO**
- Confirm the setting and return to the Menu Screen.

### NOTE

- When making a setting, you can press the **EXIT [PEAK CLEAR]** button to cancel the changes and return to the Menu Screen.
- When the headphones monitoring mode is set to **MONO**, the solo selection frame on the Home Screen will be for a mono channel.



- When the Home Screen or **PHONES MONITOR MODE** screen is open, press and hold the **MULTI JOG** dial while pressing and holding the **SHIFT** button to switch the headphone monitoring mode between **STEREO** and **MONO**.



## Setting the lock function

You can set the lock function to prevent this unit from being controlled from its front panel or an external device.

1. Press the **MENU** button while pressing and holding the **HOME [METER]** button on the front of the unit to open the **LOCK SETUP** page.

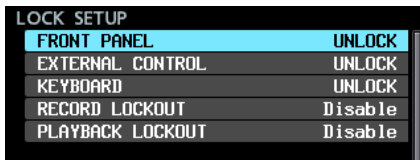

2. Select the lock function to set, and open the lock function setting screen. (See “Menu operation procedures” on page 16.)

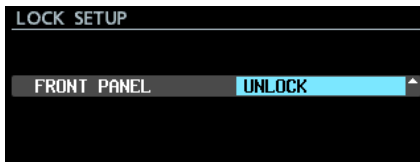

### FRONT PANEL

This locks the controls on the front of the unit.

Options: UNLOCK (default), LOCK

### NOTE

*The following operations are possible even when set to LOCK.*

- *Showing the Home Screen*
- *Using the INFO Button*
- *Changing settings on the LOCK SETUP screen*
- *Turning the power off with the STANDBY/ON switch*
- *Adjusting the brightness of the color display and various indicators*

### EXTERNAL CONTROL

This locks external control from the RS-422 and PARALLEL connectors, as well as file transfer and remote control by Telnet using an FTP client application.

Options: UNLOCK (default), LOCK

### KEYBOARD

This locks operation using a USB keyboard or numeric keypad connected to the **USB2.0** port and keyboard and mouse operation from a VNC viewer application (See “VNC (virtual network computing)” on page 44.).

Options: UNLOCK (default), LOCK

### RECORD LOCKOUT

This locks record operations.

Set this to **Enable** if you want to use the unit as a playback device and not allow recording.

Options: Disable (default), Enable

### PLAYBACK LOCKOUT

This locks playback operations.

Set this to **Enable** if you want to use the unit as a recording device and not allow playback.

Options: Disable (default), Enable

3. Press the **EXIT [PEAK CLEAR]** button to return to the Menu Screen.

# 4 – Recording

In this chapter, we explain basic recording operation procedures.

## NOTE

The maximum number of recording channels for this unit depends on the sampling frequency as follows.

- 44.1/48kHz: 64 channels
- 88.2/96kHz: 32 channels

## Restrictions on recording operations

Due to the specifications of this unit, recording will be restricted when the total number of files and folders inside one folder becomes great. This restriction is as follows.

- Recording might be restricted when the total number of files and folders inside a single folder exceeds 10,000

In this case, recording a new take from a stopped state might not be possible.

If such a folder is loaded, recording to that folder might not be possible. The following pop-up message will appear in such cases. At such times, Rec Limit will also appear in the remaining recordable time area on the Home Screen.

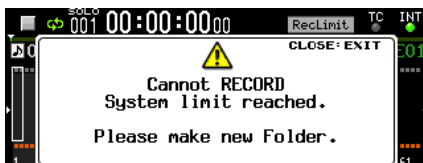

## CAUTION

The total number of files and folders inside a folder includes files and folders created by devices other than this unit. This also includes files and folders that ordinarily cannot be seen, including management files and system files.

## Setting the master clock

The unit's master clock can be set.

## CAUTION

Set up a system with multiple connected digital audio devices so that it uses only one master clock.

1. Select the **CLOCK MASTER** item on the **GENERAL** page to open the **CLOCK** screen. (See "Menu operation procedures" on page 16.)

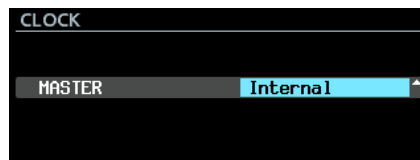

2. Set the master clock.

Option	Meaning
Internal (default)	The unit's internal clock is used.
WORD	Synchronize with the word clock signal input through the <b>WORD/VIDEO IN</b> connector.
VIDEO	Synchronize with the video clock signal input through the <b>WORD/VIDEO IN</b> connector.
SLOT 1	Synchronize with the SLOT 1 digital signal clock.
SLOT 2	Synchronize with the SLOT 2 digital signal clock.

3. Confirm the setting and return to the Menu Screen.

## NOTE

- When synchronizing with video clock, the frame rate of the input signal and this unit's **TC FRAME TYPE** setting must match. (See "TC FRAME TYPE" on page 37.)
- If synchronization with the set master clock is not possible, the unit will switch to its built-in clock and an asterisk (\*) will appear at the end of the selected setting name.
- When synchronization with the external master clock becomes possible again, External Clock Regained. Switch to External? will appear as a pop-up message.

Press the **MULTI JOG** dial to switch from using the built in clock to using the external clock as the master clock.

Press the **EXIT [PEAK CLEAR]** button to close the pop-up menu and continue using the built-in clock as the master clock. In this case, \* (Regained) will appear at the end of the selected setting name.

- When \* (Regained) appears at the end of the selected setting name, press the **MULTI JOG dial** to open a Switch to Regained External Clock? pop-up message. Press the **MULTI JOG dial** to switch from using the built in clock to using the external clock as the master clock.

Press the **EXIT [PEAK CLEAR]** button to close the pop-up menu and continue using the built-in clock as the master clock.

## CAUTION

When switching the master clock, noise might occur in the audio input and output.

Be aware of this when choosing when to change the master clock.

## Making word/video connector settings

Settings can be made for the **WORD/VIDEO IN** and **WORD/VIDEO THRU/OUT** connectors.

1. Select the **WORD/VIDEO SETUP** item on the **GENERAL** page to open the **WORD/VIDEO SETUP** screen. (See “Menu operation procedures” on page 16.)

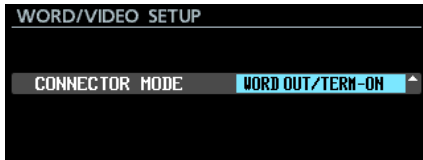

2. Set the word clock output signal.

Option	Meaning
WORD OUT/ TERM-ON (default)	Set the signal output from the <b>WORD/VIDEO OUT/THRU</b> connector to WORD OUT, and turn <b>WORD/VIDEO IN</b> connector termination resistance (75Ω) on.
WORD OUT/ TERM-OFF	Set the signal output from the <b>WORD/VIDEO OUT/THRU</b> connector to WORD OUT, and turn <b>WORD/VIDEO IN</b> connector termination resistance (75Ω) off.
THRU OUT/ TERM-OFF	Set the signal output from the <b>WORD/VIDEO OUT/THRU</b> connector to THRU output of the signal from the <b>WORD/VIDEO IN</b> connector, and turn <b>WORD/VIDEO IN</b> connector termination resistance (75Ω) off.

3. Confirm the setting and return to the Menu Screen.

## Setting the reference level

You can set the analog input and output headroom (difference between the maximum and reference levels).

1. Select the **REFERENCE LEVEL** item on the **GENERAL** page to open the **REFERENCE LEVEL** screen. (See “Menu operation procedures” on page 16.)

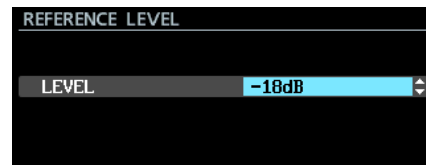

2. Set the reference level.

Option	Meaning
-9dB	+6dBu standard level, +15dBu maximum level
-14dB	+4dBu standard level, +18dBu maximum level
-16dB	+4dBu standard level, +20dBu maximum level
-18dB (default)	+4dBu standard level, +22dBu maximum level
-20dB	+4dBu standard level, +24dBu maximum level

3. Confirm the setting and return to the Menu Screen.

## Setting input monitoring

Turn input monitoring off before playing back recordings.

Audio input through jacks for channels that have input monitoring on will be output from the unit's audio output jacks.

1. Select the **INPUT MONITOR** item on the **GENERAL** page to open the **INPUT MONITOR** screen. (See “Menu operation procedures” on page 16.)

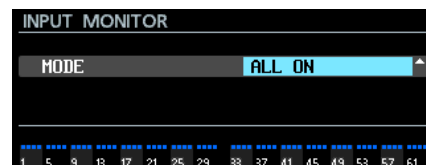

2. Set the input monitoring mode.

Options:

**ALL ON**: Turn input monitoring on for all channels

**ALL OFF** (default): Turn input monitoring off for all channels

**Individual**: Allow input monitoring to be turned on/off for specific channels individually or all at once

3. Confirm the setting and return to the Menu Screen.

## 4 – Recording

### Setting input monitoring for specific channels

When the **MODE** on the **INPUT MONITOR** screen is set to **Individual**, input monitoring can be turned on/off for specific channels individually or all at once.

1. Open the **INPUT MONITOR** screen. (See “Menu operation procedures” on page 16.)
2. On the **INPUT MONITOR** screen, set the input monitoring mode to **Individual**.

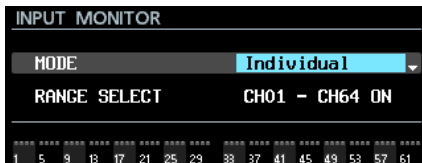

Underneath the **MODE** item, the **RANGE SELECT** item appears.

3. Press the **MULTI JOG** dial to confirm and move the cursor to the next item.

Use the **◀◀/▶▶** [**MARK** **◀◀/▶▶**] buttons to move the cursor.

When the cursor is at **ON** or **OFF**, press the **MULTI JOG** dial to open a confirmation pop-up message.

When the confirmation message is open, press the **MULTI JOG** dial to set all channels at once.

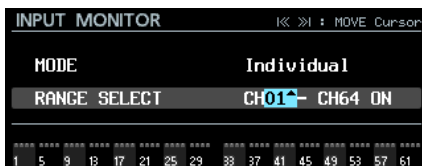

Setting the first channel to be included when selecting a range of channels at once

Options:

**CH01-CH63**: First channel included when selecting a range of channels at once

**CH02-CH64**: Last channel included when selecting a range of channels at once

**OFF/ON**: Input monitoring status for range of channels selected at once

4. By moving the cursor to the input monitoring indicator area, you can set input monitoring for individual channels.

Press the **MULTI JOG** dial to enable/disable monitoring for the channel where the cursor is.

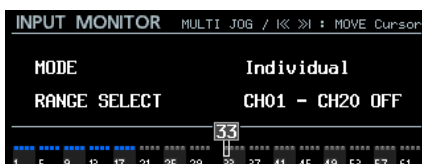

#### NOTE

*You can also turn the **MULTI JOG** dial to select a channel. Turn the **MULTI JOG** dial while pressing and holding the **SHIFT** button to move the cursor by 4 channels at a time.*

### Making recording channel settings

1. Select the **REC FUNCTION** item on the **REC FILE FORMAT** page to open the **REC FUNCTION** screen. (See “Menu operation procedures” on page 16.)

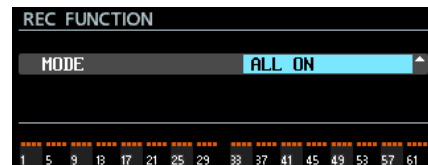

2. Set the recording function mode.

Options

**ALL ON** (default): Recording is enabled for all channels

**ALL OFF**: Recording is disabled for all channels

**Individual**: Allow recording to be enabled/disabled for specific channels individually or all at once

3. Confirm the setting and return to the Menu Screen.

### Setting the record function for specific channels

When the **MODE** on the **REC FUNCTION** screen is set to **Individual**, recording can be enabled/disabled for specific channels individually or all at once.

1. Open the **REC FUNCTION** screen. (See “Menu operation procedures” on page 16.)
2. Set the recording function mode on the **REC FUNCTION** screen to **Individual**.

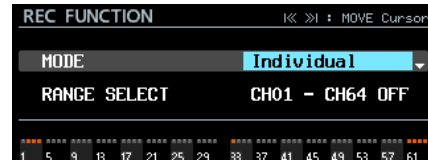

Underneath the **MODE** item, the **RANGE SELECT** item appears.

3. Press the **MULTI JOG** dial to confirm and move the cursor to the next item.

Use the **◀◀/▶▶** [**MARK** **◀◀/▶▶**] buttons to move the cursor.

When the cursor is at **ON** or **OFF**, press the **MULTI JOG** dial to open a confirmation pop-up message.

When the confirmation message is open, press the **MULTI JOG** dial to set all channels at once.

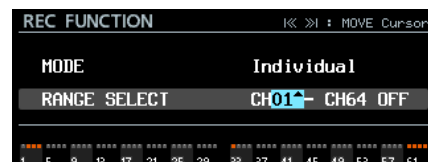

Setting the first channel to be included when selecting all channels at once

Options:

CH01–CH63: First channel included when selecting a range of channels at once

CH02–CH64: Last channel included when selecting a range of channels at once

OFF/ON: Record function status for range of channels selected at once

- By moving the cursor to the record function display area, you can enable/disable recording for individual channels. Press the **MULTI JOG** dial to enable/disable recording for the channel where the cursor is.

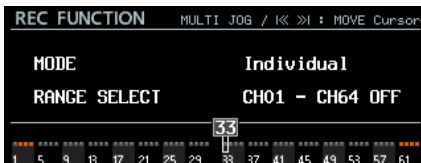

### NOTE

You can also turn the **MULTI JOG** dial to select a channel. Turn the **MULTI JOG** dial while pressing and holding the **SHIFT** button to move the cursor by 4 channels at a time.

## Setting the recording file format

The quantization bit depth and sampling frequency used when recording files can be set.

- Select the **BIT LENGTH** item on the **REC FILE FORMAT** page to open the **BIT LENGTH** screen. (See “Menu operation procedures” on page 16.)



- Set the quantization bit depth.  
Options: 16bit, 24bit (default)
- Confirm the setting and return to the **REC FILE FORMAT** page.
- Turn the **MULTI JOG** dial to select the **REC Fs** item.
- Press the **MULTI JOG** dial to open the **REC Fs** screen.

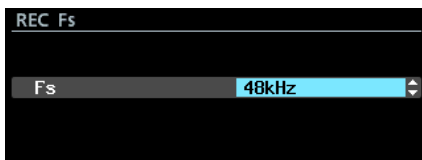

- Set the sampling frequency used for recording.  
Options: 44.1kHz, 48kHz (default), 88.2kHz, 96kHz
- Confirm the setting selection to change the sampling frequency used by the unit and return to the Menu Screen.

When the setting is changed from 44.1/48kHz to 88.2/96kHz or from 88.2/96kHz to 44.1/48kHz, a message appears confirming that the maximum number of recording channels has changed, as shown below.

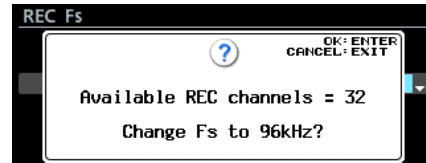

When this message is open, press the **MULTI JOG** dial to confirm the sampling frequency change and return to the Menu Screen.

### NOTE

The maximum number of recording channels for this unit is as follows.

- 44.1/48kHz recording sampling frequency: 64 channels
- 88.2/96kHz recording sampling frequency: 32 channels

# 4 – Recording

## Setting the file name format

You can select the format of names given to files automatically during recording.

1. Select the **FILE NAME** item on the **REC FILE FORMAT** page to open the **FILE NAME** screen. (See “Menu operation procedures” on page 16.)

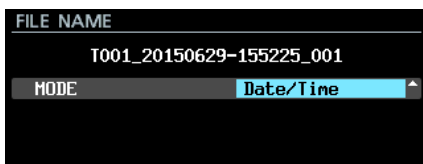

2. Select one of the following file name formats.

### Options

**Date/Time** (default): The date and time of the unit's built in clock is used for the file name.

**Folder Name**: The name of the folder is used for the file name.

**User Word**: The text set by the user (maximum of 31 characters) is used for the file name.

3. If you selected **Date/Time** or **Folder Name** (or **User Word** and you do not want to change the text used for the file name), press the **MULTI JOG** dial to return to the menu.

If you selected **User Word** and you want to change the text used for the file name, press the **▶▶| [MARK ▶▶|]** button to open the **User Word** screen.

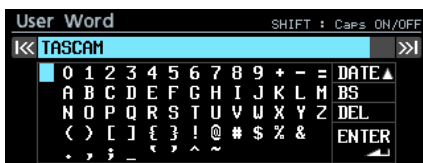

4. Edit the text used for the file name. For details about how to edit the text, see “Editing text” on page 26.
5. After you finish editing, select **ENTER** to confirm the edited text and returned to the **FILE NAME** screen.
6. Confirm the setting and return to the **Menu Screen**.

## Editing text

Use these operations to edit text.

### ■ Changing the cursor (editing point) position

Use the **◀◀/▶▶| [MARK ◀◀/▶▶|]** buttons on the unit.

### ■ Changing the character input:

Turn the **MULTI JOG** dial.

### ■ Inputting the selected character at the cursor (editing) position:

Press the **MULTI JOG** dial.

### ■ Leaving a single space open:

Turn the **MULTI JOG** dial to select a blank space at the left end of any row, and press the **MULTI JOG** dial.

### ■ Deleting a character:

Turn the **MULTI JOG** dial to select **DEL** (to delete a character to the right of the cursor) or **BS** (to delete a character to the left of the cursor), and press the **MULTI JOG** dial.

### ■ Deleting all characters to the right of the cursor:

Turn the **MULTI JOG** dial to select **DEL**, and press and hold the **MULTI JOG** dial.

### ■ Deleting all characters to the left of the cursor:

Turn the **MULTI JOG** dial to select **BS**, and press and hold the **MULTI JOG** dial.

### ■ Switching between upper and lower case:

Press the **SHIFT** button.

### ■ Canceling edits:

Press the **EXIT [PEAK CLEAR]** button.

### ■ Inputting the date.

Turn the **MULTI JOG** dial to select **DATE ▲**. Press the **MULTI JOG** dial to input the date and time of the built-in clock in “yyyy-mm-dd” format.

On the **RENAME FOLDER** screen, if a folder with the same name already exists, an underscore ( **\_** ) followed by a number that has not already been used will be added to the end of the name.

## CAUTION

- You can connect the **SSD/HDD** to a computer and edit file names from the computer. Doing so, however, could cause the order of the files to change when played back on the unit.
- On a text input screen, characters other than English letters, numerals and symbols will not be shown. If text includes characters other than English letters, numerals and symbols, opening a text input screen will delete them.
- The following symbols and punctuation marks cannot be used in text.  
¥ / : \* ? " < > |

## NOTE

You can also use a **USB keyboard** to edit characters. (See “Using the keyboard to input names and values” on page 53.)

### ■ Character input limit

The blue background in the character field indicates the maximum number of characters. The gray background shows characters in excess of the maximum number. These will be discarded when you select **Enter** and confirm the input text.



## Automatically incrementing take numbers

The unit can automatically increment take numbers when set conditions are met during recording. Each time the take number is incremented, a new audio file is created.

Use the menu to select the auto file incrementation mode and make specific settings.

1. Select the **AUTO FILE INCREMENT** item on the **REC FILE FORMAT** page to open the **AUTO FILE INCREMENT** screen. (See “Menu operation procedures” on page 16.)

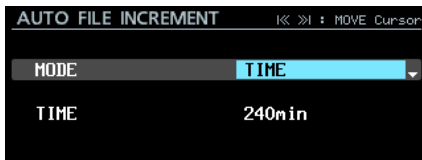

When **MODE** is set to **TIME**

2. Set the auto file incrementation mode.

Options

- SIZE:** Increment whenever the set size is reached.
- TIME (default):** Increment whenever the set time is reached.

### NOTE

*When the **AUTO FILE INCREMENT** screen is open, use the **MARK** buttons to move the cursor between setting items.*

3. Press the **MULTI JOG** dial to confirm the setting. Move the cursor to the next setting item.
4. Turn the **MULTI JOG** dial to select an option.

In **SIZE** mode

Options: 640MB (77min), 1GB (124min), 2GB (248min)(default)

In **TIME** mode

Options: 1min–240min (1-minute increments, default is 240min)

### NOTE

- When using **SIZE** mode, the time values in parentheses next to the **SIZE** item options change according to the **REC FS** and **BIT LENGTH** screen settings.
  - When using **TIME** mode and the cursor is on the **TIME** item, turn the **MULTI JOG** dial while pressing and holding the **SHIFT** button to change the time in 10-minute increments.
5. Confirm the setting and return to the Menu Screen.

## Incrementing take numbers manually

You can press the **[SPLIT]** button during recording to increment the take number.

A message will appear if incrementing is not possible when you press the **[SPLIT]** button due to system limitations under conditions like the following.

- When the **[SPLIT]** button is pressed repeatedly in a short amount of time
- When the media has very little remaining open space
- When the limit to the number of files in a folder is reached

## Adding marks automatically when recording

By turning the auto mark function on, you can have the unit add marks automatically when audio level overloads occur or when synchronization errors occur because external clock is lost. Using this function, you can quickly search for locations where problems occurred during recording.

1. Select the **AUTO MARK** item on the **REC OPTIONS** page to open the **AUTO MARK** screen. (See “Menu operation procedures” on page 16.)

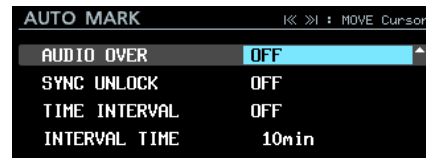

2. Use the **MULTI JOG** dial to set the following auto mark function settings.

**AUDIO OVER**

Add a mark whenever the audio level reaches 0 dB (full bit).

Options: OFF (default value), ON

**SYNC UNLOCK**

Add a mark whenever synchronization with the master clock is lost.

Options: OFF (default value), ON

**TIME INTERVAL**

Add a mark at set time intervals.

Options: OFF (default value), ON

**INTERVAL TIME**

Set the length of the interval for adding marks when the **TIME INTERVAL** item is on.

Options: 1min–240min (1-minute increments, default is 10min)

### NOTE

- When the **AUTO MARK** screen is open, use the **MARK** buttons to move the cursor between setting items.
  - When the **AUTO MARK** screen is open and the cursor is at the **INTERVAL TIME** item, turn the **MULTI JOG** dial while pressing and holding the **SHIFT** button to change the time in 10-minute increments.
3. When the cursor is at the **INTERVAL TIME** item, press the **MULTI JOG** dial to confirm the setting and return to the menu.

### NOTE

- After an **AUDIO OVER** or **SYNC UNLOCK** mark is added, the same type of mark will not be added again until at least 10 seconds have passed.
- For an **AUDIO OVER**, a mark named “OVERxx” will be added.
- For a **SYNC UNLOCK**, a mark named “UNLKxx” will be added.
- For a **TIME INTERVAL**, a mark named “TIMExx” will be added.

\*The “xx” is a number given to all marks that is incremented in order.

## 4 – Recording

### Adding marks manually when recording

You can manually add a mark to a take where you want it when recording, allowing you to find that point again quickly during playback.

#### NOTE

*Moving between marks is only possible when stopped, playing back or in playback standby. (See "Moving to marks" on page 45.)*

### Adding marks when recording

During recording when the Home Screen is open, to add a mark at a desired point, press the **MULTI JOG** dial when that point comes.

#### NOTE

- The maximum number of marks that can be added to a take is 99. The mark data is stored in the file.
- You can also add marks when the unit is stopped, playing back or in playback standby. (See "Adding marks" on page 45.)
- A mark added manually will be named "MARKxx"\*. \*The "xx" is a number given to all marks that is incremented in order.

### Setting the pause mode function

You can set the pause mode function to either divide the file or not whenever you switch the unit from recording to recording standby (pausing).

1. Select the **PAUSE MODE** item on the **REC OPTIONS** page to open the **PAUSE MODE** screen. (See "Menu operation procedures" on page 16.)

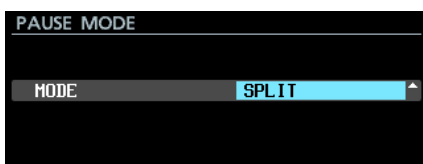

2. Set the pause mode function.

#### Options

**SPLIT** (default): Create a new file whenever recording is paused

**NO SPLIT**: Do not create a new file whenever recording is paused

3. Confirm the setting and return to the Menu Screen.

### Setting input signal routing

Set the input signal routing.

1. Open the **INPUT ROUTING 1** page or the **INPUT ROUTING 2** page and select the channel that you want to change. (See "Menu operation procedures" on page 16.)
2. This opens the **INPUT ROUTING** screen for the selected channel.

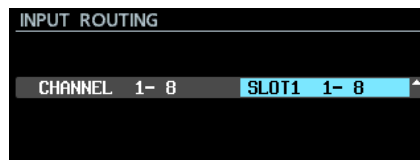

INPUT ROUTING screen CHANNEL 1-8

3. Set the signals input to the channel.

#### Options:

**SLOT1 1- 8** (default for CHANNEL 1-8)  
**SLOT1 9-16** (default for CHANNEL 9-16)  
**SLOT1 17-24** (default for CHANNEL 17-24)  
**SLOT1 25-32** (default for CHANNEL 25-32)  
**SLOT1 33-40** (default for CHANNEL 33-40)  
**SLOT1 41-48** (default for CHANNEL 41-48)  
**SLOT1 49-56** (default for CHANNEL 49-56)  
**SLOT1 57-64** (default for CHANNEL 57-64)  
**SLOT2 1- 8**  
**SLOT2 9-16**  
**SLOT2 17-24**  
**SLOT2 25-32**  
**SLOT2 33-40**  
**SLOT2 41-48**  
**SLOT2 49-56**  
**SLOT2 57-64**

4. Confirm the setting and return to the Menu Screen.

### Making I/O card settings

After installing an I/O card (sold separately) in **SLOT 1** or **SLOT 2**, information about that card and its settings are available on the **SLOT 1** or **SLOT 2** page.

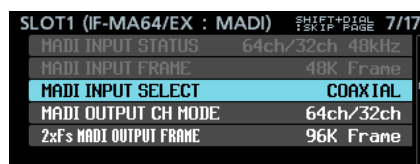

When IF-MA64/EX installed

#### NOTE

*No Card is shown when no I/O card (sold separately) is installed.*



## Settings for IF-MA64/EX and IF-MA64/BN cards

### ■ MADI INPUT STATUS

This shows the channel mode/frame frequency of the MADI input signal.

Example: 64ch/32ch 48kHz

If there is no input signal, no signal is shown.

### ■ MADI INPUT FRAME

This shows the MADI input signal frame type (48K Frame/96K Frame).

If there is no input signal, no signal is shown.

### ■ MADI INPUT SELECT (IF-MA64/EX only)

Set the input connector used.

Options: COAXIAL (default), OPTICAL

### ■ MADI OUTPUT CH MODE

Set the output channel mode.

Options: 64ch/32ch (default), 56ch/28ch

### NOTE

*Left of /: 1×Fs channel mode*

*Right of /: 2×Fs channel mode*

### ■ 2×Fs MADI OUTPUT FRAME

Set the MADI output signal frame type when the unit's sampling frequency is 88.2/96kHz.

Options: 48K Frame, 96K Frame (default)

### CAUTION

*A MADI signal with a 88.2/96kHz sampling frequency and 48K Frame type cannot be distinguished from a 44.1/48kHz sampling frequency MADI signal.*

*For this reason, a 48K Frame MADI input signal that does not match the sampling frequency of the receiving device cannot be received as proper audio data.*

*When using a 48K Frame MADI signal, always match the sampling frequencies of the signal sending and receiving devices.*

### NOTE

*The signal from the IF-MA64/EX MADI COAXIAL IN connector is output through its MADI COAXIAL THRU connector whether the unit is on or off.*

*When the unit is turned on/off, however, the signal output from the MADI COAXIAL THRU connector will be momentarily disrupted.*

*For this reason, time turning the unit on/off carefully when the signal output from the MADI COAXIAL THRU connector is being used by a connected device.*

## Timecode synchronized recording

This unit captures the timecode from its built-in timecode generator at the start of recording and uses it as the file start time.

## Recording duration

The table below shows maximum recording times by file format on SSD/HDD drives of different capacities.

File format used	Media capacity			
	80GB	120GB	240GB	480GB
16-bit/44.1kHz/64-channel	3h 55m	5h 53m	11h 47m	23h 35m
16-bit/48kHz/64-channel	3h 36m	5h 24m	10h 49m	21h 40m
24-bit/44.1kHz/64-channel	2h 36m	3h 55m	7h 51m	15h 43m
24-bit/48kHz/64-channel	2h 24m	3h 36m	7h 13m	14h 26m
24-bit/88.2kHz/32-channel	2h 36m	3h 55m	7h 51m	15h 43m
24-bit/96kHz/32-channel	2h 24m	3h 36m	7h 13m	14h 26m

- The recording times shown above are estimates. They might differ depending on the media used.
- The recording times shown above are not continuous recording times, but rather they are the total possible recording times for the media.

# 5 – Working with Folders (BROWSE screen)

You can manage audio files on the SSD/HDD drive in a folder structure.

After selecting a folder to work with on the BROWSE screen, you can open a folder pop-up menu.

You can also create folders from the menu.

## NOTE

- *Using a computer to read the contents of SSD/HDD drives, you can change the folder structure, edit the names of folders and files, and delete folders and files, for example.*
- *Making changes with a computer, however, could cause the order of the files to change when played back on the unit.*

## Opening the BROWSE screen

Select the BROWSE item on the GENERAL page to open the BROWSE screen. (See “Menu operation procedures” on page 16.)

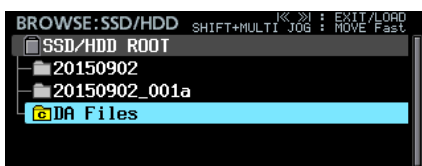

## Navigating the BROWSE screen

On the BROWSE Screen, folders appear in a list in the same way files are shown on a computer.

When the BROWSE screen is open, use the MULTI JOG dial or I◀◀/▶▶I [MARK I◀◀/▶▶I] buttons to select a file or folder for use.

- Press the MULTI JOG dial to open the folder pop-up menu. (See “Folder operations” on page 30.)
- Press the EXIT [PEAK CLEAR] button to move up one folder level.

At the media selection level, press the EXIT [PEAK CLEAR] button to return to the Menu Screen.

Press the EXIT [PEAK CLEAR] button when using a folder menu to go back one operation.

- Turn the MULTI JOG dial to select a folder or file.
- When a file or folder is selected, press the I◀◀ [MARK I◀◀] button to move up one level or the ▶▶I [MARK ▶▶I] button to move down one level. You can also change levels when a folder is selected by turning the MULTI JOG dial to open the pop-up folder menu and select the ENTER or LOAD item. This will move up one level if the top line of the BROWSE screen is selected and down one level if the second or later line is selected.
- When a folder or file is selected, press the HOME [METER] button to return to the Home Screen.
- When a take is selected, press the ▶ button to return to the Home Screen and play that take.
- When a take is selected, press the II [CHASE] button to return to the Home Screen and enter playback standby at the beginning of that take.

## Icons on the BROWSE screen

The icons that appear on the BROWSE Screen are as follows.

### ■ Plain folder

The folder name appears next to the folder icon.

“C” appears in a yellow folder icon for the current folder.

### ■ Take

The file name appears next to the take icon.

The take icon appears yellow for the current take.

### ■ Audio file

The audio icon appears for audio files included in a take.

### ■ Other files

The file name appears next to the file icon.

## Folder operations

Select the desired folder on the BROWSE Screen and press the MULTI JOG dial to open the pop-up folder menu.

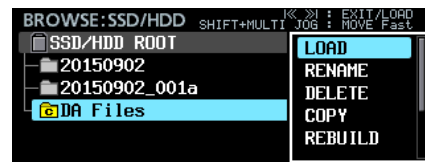

Turn the MULTI JOG dial to select the desired operation, and press the MULTI JOG dial to execute it as follows.

### ■ ENTER/EXIT

Press the MULTI JOG dial when the ENTER item is shown to enter the selected folder and view its contents as a list.

Press the MULTI JOG dial when the EXIT item is shown to close the selected folder and move up one level.

### ■ LOAD

Select as the current folder, enter it and view its contents as a list.

## NOTE

*Only a folder in the root directory of the SSD/HDD can be selected as the current folder. Folders in other locations cannot be selected as the current folder.*

### ■ RENAME

Open the RENAME FOLDER screen where you can edit the name of the selected folder. (See “Editing folder, take and file names” on page 31.)

### ■ DELETE

Delete the selected folder. (See “Deleting folders, takes and files” on page 32.)

### ■ COPY

Copy the selected folder. (See “Copying folders, takes and files” on page 32.)

### ■ REBUILD

Use this to rebuild the selected folder after deleting a file from the unit by FTP, for example. (See “Rebuilding folders” on page 33.)

This can only be done when the unit is stopped.

# 5 – Working with Folders (BROWSE screen)

## ■ INFO

Open a pop-up with the creation date and time of the selected folder.

## ■ CREATE

Create a new folder. (See “Creating new folders” on page 33.)

## ■ CANCEL

Close the folder menu.

## Take and file operations

Select the desired take or file on the BROWSE Screen and press the **MULTI JOG** dial to open the pop-up file menu.

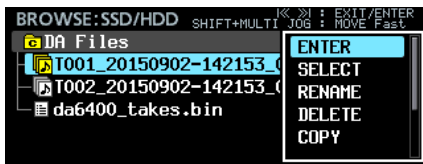

Turn the **MULTI JOG** dial to select the desired operation, and press the **MULTI JOG** dial to execute it as follows.

## ■ ENTER (only when take selected)

This shows the file list of the selected take.

## ■ SELECT (only when take selected)

Set the selected take as the current take and return to the Home Screen.

## ■ RENAME

Open the RENAME TAKE or RENAME FILE screen where you can edit the name of the selected take or file. (See “Editing folder, take and file names” on page 31.)

## ■ DELETE

Delete the selected file. (See “Deleting folders, takes and files” on page 32.)

## ■ COPY

Copy the selected file. (See “Copying folders, takes and files” on page 32.)

## ■ EDIT TC (only when take selected)

Edit the start timecode of the selected take. (See “Editing the start timecode of a take” on page 33.)

## ■ INFO

Open a pop-up with information about the selected take or file.

If the selected file is a take, information is shown on two pages as follows. Press the **MULTI JOG** dial to switch between the two pages.

Page	Contents
1st	Creation date and time
	Sampling frequency/bit length/number of channels
	File capacity
	File length
2nd	START timecode
	END timecode
	Frame type

If the selected file is not a take, the creation date and time and file capacity are shown.

## ■ CANCEL

Close the file menu.

## Editing folder, take and file names

1. Select the folder, take or file with the name you want to edit, and open the folder/file pop-up menu.
2. Select the RENAME item to open the RENAME FOLDER, RENAME TAKE or RENAME FILE screen.



Editing a folder name

3. Edit the name.  
For details about how to edit the text, see “Editing text” on page 26.
4. After you finish editing the name, select ENTER to confirm it.  
A Renaming... pop-up appears while the name is being changed.  
After renaming completes, the BROWSE screen reopens.

## CAUTION

- You can connect the SSD/HDD to a computer and edit names from the computer. Doing so, however, could cause the order of the files to change when played back on the unit.
- On a text input screen, characters other than English letters, numerals and symbols will not be shown. If text includes characters other than English letters, numerals and symbols, opening a text input screen will delete them.
- The following symbols and punctuation marks cannot be used in text.

¥ / : \* ? " < > |

# 5 – Working with Folders (BROWSE screen)

## Deleting folders, takes and files

You can delete folders, takes and files from SSD/HDD drives and USB flash drives.

Deleting a folder will also delete all the files it contains.

1. Select the folder, take or file that you want to delete, and open the folder/file pop-up menu.
2. Select the **DELETE** item, and press the **MULTI JOG** dial. The following pop-up message will appear.



When deleting a folder

### NOTE

Press the **EXIT [PEAK CLEAR]** button to cancel deletion.

3. Press the **MULTI JOG** dial.  
A second confirmation pop-up message will appear.



When deleting a folder

4. Press and hold the **MULTI JOG** dial to delete the selected folder, take or file.  
A pop-up with, for example, **Deleting Folder...** appears while the folder, take or file is being deleted.  
When deleting completes, the Home Screen opens.

## Copying folders, takes and files

1. Select the folder, take or file that you want to copy, and open the folder/file pop-up menu.
2. Select the **COPY** item, and press the **MULTI JOG** dial to open the copy destination folder selection screen.
3. Move to the copy destination folder.
  - If it is the first time copying, the media selection screen will open. Select the media that contains the copy destination folder and then move to that folder.

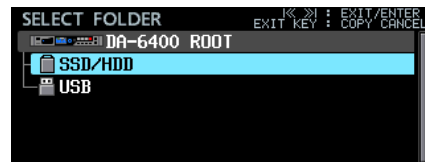

- If it is the second or later time, the last shown copy destination folder selection screen will reopen.

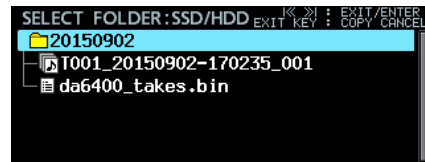

### NOTE

- During copy destination folder selection, **BROWSE** changes to **SELECT FOLDER** and blinks.
  - While selecting a copy destination folder, press the **EXIT [PEAK CLEAR]** button to open a **CANCEL COPY?** confirmation pop-up message. Press the **MULTI JOG** dial to close the copy destination folder selection screen and return to the **BROWSE** screen.
  - While the copy destination is selected, select the **CANCEL** item from the pop-up menu and press the **MULTI JOG** dial to close the copy destination folder selection screen and return to the **BROWSE** screen.
4. Select the copy destination folder, and open the folder pop-up menu.

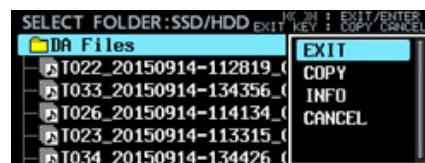

5. Select the **COPY** item, and press the **MULTI JOG** dial to open a confirmation pop-up message.



When copying a folder



## 5 – Working with Folders (BROWSE screen)

- Press the **MULTI JOG** dial to copy the item.  
Press the **EXIT [PEAK CLEAR]** button to cancel copying or change the copy destination.

### NOTE

*If a folder/take/file with the same name already exists in the copy destination, a Cannot Copy Folder, Cannot Copy Take or Cannot Copy File pop-up message will open.*

*To change the name of the copied folder/take/file, press the **MULTI JOG** dial.*

*For details about how to input text, see “Editing text” on page 26.*

*Press the **EXIT [PEAK CLEAR]** button to cancel copying.*

- A progress pop-up appears while the item is being copied. When copying completes, the pop-up disappears and the **BROWSE** screen reopens.

## Rebuilding folders

Use this to rebuild a folder when discrepancies occur between management and audio files after deleting a file from the unit by FTP, for example.

- Select the folder to rebuild, and press the **MULTI JOG** dial to open the pop-up folder menu.
- Select the **REBUILD** item in the folder menu, and press the **MULTI JOG** dial.  
A confirmation pop-up message appears.

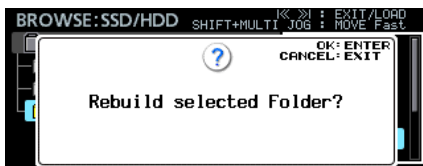

- Press the **MULTI JOG** dial to rebuild the folder.

## Editing the start timecode of a take

- Select the take with the start timecode you want to edit, and press the **MULTI JOG** dial to open the pop-up file menu.
- Select the **EDIT TC** item in the file menu, and press the **MULTI JOG** dial.  
The **EDIT TAKE TC** screen opens.



- Use the **MULTI JOG** dial to change the time.  
Press the **MULTI JOG** dial when the cursor is in the last field to confirm the setting and return to the **BROWSE** screen.

### NOTE

- When editing, you can press the **EXIT [PEAK CLEAR]** button to cancel the changes and return to the **BROWSE** screen.
- You can also use a USB keyboard to input numbers.

## Creating new folders

- Open the pop-up folder menu.
- Select the **CREATE** item to open the **CREATE FOLDER** screen.



- Input the folder name.  
For details about how to input a folder name, see “Editing text” on page 26.
- After you finish editing the folder name, select **ENTER** to confirm it.  
A confirmation pop-up message will appear.



### NOTE

*During folder creation, press the **EXIT [PEAK CLEAR]** button to cancel it.*

- Press the **MULTI JOG** dial to create the new folder.  
A **Creating Folder...** pop-up appears while the new folder is being created.  
After creation of the new folder completes, the **BROWSE** screen reopens and the new folder becomes the current folder.

### NOTE

- The maximum number of folders that can be created on a single level is 1000.
- The initial folder name shown will be the year, month and day of the built-in clock. (Example: 20150301)
- If this would be the same as the existing name, a three-digit number is added after the year, month and day of the built-in clock. Example: 20150301\_001

# 5 – Working with Folders (BROWSE screen)

## Folder structure overview

This unit manages audio files inside audio folders. In order to keep takes together on an SSD/HDD drive, there are audio folders such as “DA Files” and audio file groups called takes inside audio folders.

## Folder structure

The folder structure is as shown in the illustration below. You can use a USB cable to connect the SSD/HDD to a computer and check the folder and file structure from it.

### CAUTION

*Changing or deleting files inside folders, or changing their names might make it impossible for the unit to play back those folders.*

### NOTE

- Other folders and files used for management are also created.
- Only a folder in the root directory of the SSD/HDD can be selected as the current folder. Folders in other locations cannot be selected as the current folder.

## File name

The rules for file names are as follows  
T[3-digit take number]\_[file name]\_[3-digit number]\_[2-digit channel number].wav

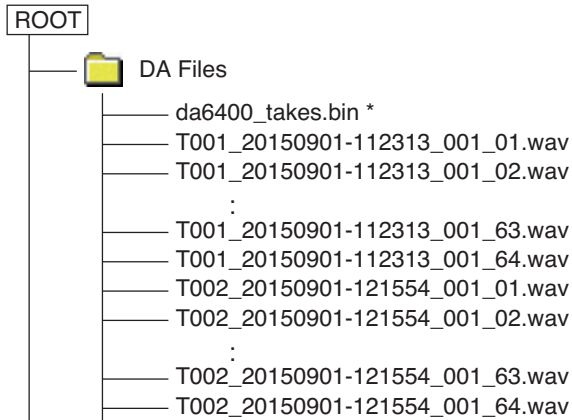

\*: automatically created audio management file

## File formats

This unit can record and play files of the following formats.

File formats: BWF, WAV\*

Sampling frequencies: 44.1, 48, 88.2, 96 kHz

Quantization bit depth: 16/24-bit

Number of channels: 1

\*This unit cannot record WAV files, but it can play them back.

### NOTE

- This unit recognizes and groups up to 64 mono WAV files together as a single take if they have file names in the format “[name]\_[2-digit channel number].wav”.
- If the channel number has only one digit, a “0” will be added to the beginning of the number, resulting in “01” and “02”, for example.
- If the 2-digit channel number is “65” or higher in the name of a WAV file, it will be recognized as a single take.
- If the name of a WAV file does not have a 2-digit channel number, it will be recognized as a single take.

This chapter explains functions for playing back audio files stored on SSD/HDD drives.

This explanation assumes that you have already installed an SSD/HDD drive that contains audio files into the unit and that the unit is on.

## Files that can be played back

This unit can play back files in the following formats.

- File formats: BWF, WAV
- Sampling frequencies: 44.1, 48, 88.2, 96 kHz
- Quantization bit depth: 16/24-bit
- Number of channels: 1

### CAUTION

*Takes with sampling frequencies that are different from that set on the REC F<sub>3</sub> screen cannot be played back.*

*To play takes with sampling frequencies that are different from that set on the REC F<sub>3</sub> screen, change the setting on the REC F<sub>3</sub> screen. (See “Setting the recording file format” on page 25.)*

### NOTE

*The maximum number of playback channels for this unit depends on the sampling frequency as follows.*

- 44.1/48kHz: 64 channels
- 88.2/96kHz: 32 channels

## Basic playback operations

This section explains basic operations, including starting, stopping and pausing play.

This explanation assumes that you have already made necessary connections, turned the unit on, installed an SSD/HDD drive that contains audio files and opened the Home Screen on the display.

### Playing recordings

Press the ► button on the unit to start playback.

If the media does not contain any audio files that the unit can play, a **There is no take.** pop-up message will appear.

#### ■ Stopping playback:

Press the ■ button.

#### ■ Pausing playback:

Press the ■ [CHASE] button.

## Selecting takes

This section explains how to select a take when there are multiple takes.

### Skipping to the previous/next take

Use the I◀◀/▶▶I [MARK I◀◀/▶▶I] buttons to skip to the previous/next take.

## Selecting takes directly

1. On the BROWSE screen, turn the **MULTI JOG** dial to select that take you want to play.
2. Press the **MULTI JOG** dial to open the file menu.
3. Select the SELECT item in the file menu and press the **MULTI JOG** dial to make the selected take the current take and return to the Home Screen.

## Searching backward and forward

You can search backward and forward within a take.

1. Play or pause the desired take.
2. Press and hold the ◀◀/▶▶ button to search backward/forward.
3. Release the button to stop searching and resume the previous state (playing or paused).

### NOTE

*When searching backward/forward, press and hold the other ◀◀/▶▶ button for the opposite direction to search at high speed.*

## Setting the play mode

This sets the playback mode.

1. Select the PLAY MODE item on the PLAY SETUP page to open the PLAY MODE screen. (See “Menu operation procedures” on page 16.)

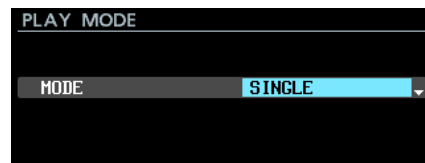

2. Set the play mode.  
Options  
SINGLE (default): Only play the currently selected take  
ALL: Play all the takes in the currently loaded folder
3. Confirm the setting and return to the Menu Screen.

## Setting the repeat mode

This turns the repeat function on or off.

1. Select the REPEAT MODE item on the PLAY SETUP page to open the REPEAT MODE screen. (See “Menu operation procedures” on page 16.)

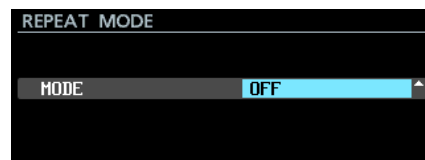

2. Turn the repeat function on or off.  
Options: OFF (default), ON
3. Confirm the setting and return to the Menu Screen.

### NOTE

*When repeat playback is on, that area will be played back according to the playback mode.*

# 7 – Internal Settings

## Setting the timecode

Use the **TC SETUP 1** and **TC SETUP 2** pages to make settings related to timecode.

### TC SETUP 1 page settings

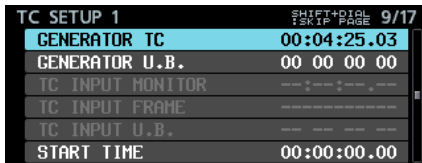

#### ■ GENERATOR TC

This shows the current timecode generator time. Select the **GENERATOR TC** item, and press the **MULTI JOG** dial to open the **GENERATOR TC** screen.

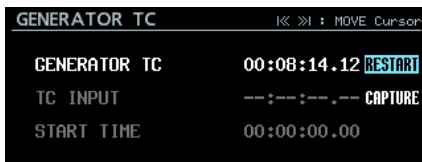

GENERATOR TC screen when set to **FREE RUN**

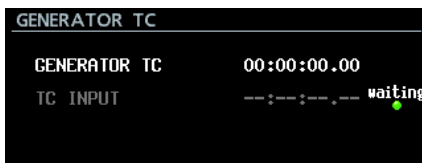

GENERATOR TC screen when not set to **FREE RUN**  
GENERATOR TC item

When the **GENERATOR MODE** item on the **TC GENERATOR MODE** screen is set to **FREE RUN**, select **RESTART** and press the **MULTI JOG** dial to reset the timecode generator timecode to the start time.

#### TC INPUT item

When the **GENERATOR MODE** item on the **TC GENERATOR MODE** screen is set to **FREE RUN**, select **CAPTURE** and press the **MULTI JOG** dial to capture the current timecode time shown for **TC INPUT** and set it as the timecode generator timecode.

When the **GENERATOR MODE** item on the **TC GENERATOR MODE** screen is set to **FREE ONCE** or **JAM SYNC**, the "waiting" (capture status) indicator lights green when waiting to capture timecode. When timecode is captured, the indicator turns off.

#### START TIME item

This shows the time when timecode resumes, which is set with the **START TIME** item on the **START TIME** screen.

#### ■ GENERATOR U.B.

This shows the user bits (U.B.) for the timecode generator. Select the **GENERATOR U.B.** item, and press the **MULTI JOG** dial to open the **GENERATOR USER BITS** screen.

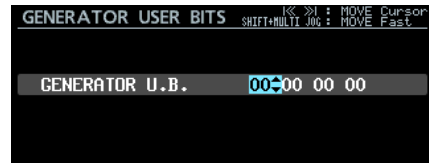

GENERATOR U.B. item  
Set the user bits (U.B.).

#### NOTE

*You can also use a USB keyboard to input numbers and the letters A-F.*

#### ■ TC INPUT MONITOR

This shows the input timecode time.

#### ■ TC INPUT FRAME

This shows the input timecode frame type.

#### ■ TC INPUT U.B.

This shows the user bits (U.B.) for the input timecode.

#### ■ START TIME

When the **RESTART** item on the **GENERATOR TC** screen is selected and the **MULTI JOG** dial is pressed, the time that the timecode restarts is shown in the **GENERATOR TC** item on the **TC SETUP 1** page.

Select the **START TIME** item, and press the **MULTI JOG** dial to open the **START TIME** screen.

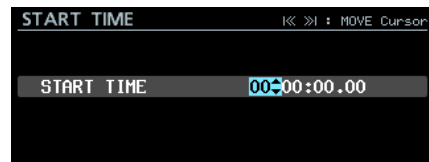

START TIME item  
Set the time when timecode resumes.

#### NOTE

*You can also use a USB keyboard to input numbers.*

## TC SETUP 2 page settings

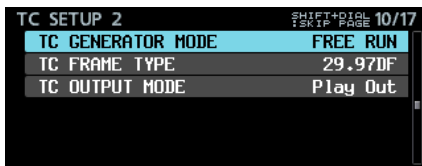

### TC GENERATOR MODE

This shows the timecode generator mode.

Select the TC GENERATOR MODE item, and press the MULTI JOG dial to open the TC GENERATOR MODE screen.

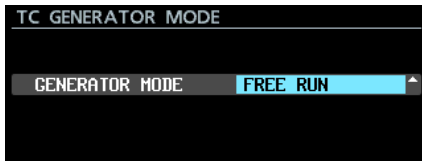

GENERATOR MODE item

This sets the internal timecode generator mode.

Option	Meaning
FREE RUN (default)	The timecode generator runs by itself from the START TIME.
FREE ONCE	After capturing the input timecode once, the generator runs by itself from the captured timecode in free run mode.
TIME OF DAY	After capturing the time from the built-in clock when one of the following operations is conducted, the generator runs by itself in free run mode. <ul style="list-style-type: none"> <li>Turning the unit on</li> <li>Changing the mode to TC GEN MODE</li> <li>Resetting the built-in clock</li> </ul>
JAM SYNC	The generator synchronizes to timecode when it is being input. If timecode input stops, the generator runs by itself in free run mode.
REGEN	The generator synchronizes to the input timecode.
REC RUN	The timecode generator runs only during recording. The timecode generator stops when not recording.
TC SYNC REC	Recording starts when the unit synchronizes with external TC, and recording pauses when synchronization with the external TC is lost.  When set to TC SYNC REC mode, the TC indicator on the Home Screen lights/blinks red. For details, see the TC indicator explanation in ⑧ Timecode status on "Home Screen" on page 12.

**NOTE**  
Set this unit and the TC to use the same frame types.

### TC FRAME TYPE

This shows the timecode frame type.

Select the TC FRAME TYPE item, and press the MULTI JOG dial to open the TC FRAME TYPE screen.

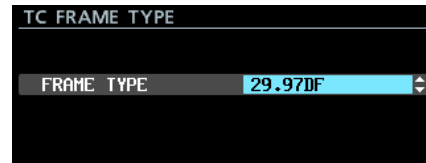

FRAME TYPE item

This sets the timecode frame type.

Options: 23.976F, 24F, 25F, 29.97DF (default), 30DF, 30NDF

### TC OUTPUT MODE

This shows the timecode output mode.

Select the TC OUTPUT MODE item, and press the MULTI JOG dial to open the TC OUTPUT MODE screen.

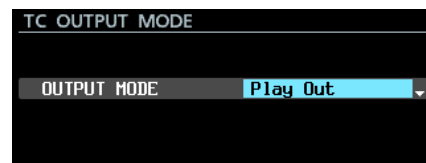

OUTPUT MODE item

This sets the timecode output mode.

Option	Meaning
Generator Out	Output the timecode of the built-in timecode generator.
Play Out (default)	This outputs the timecode contained in the file.

# 7 – Internal Settings

## PARALLEL connector settings

Use the PARALLEL INPUT and PARALLEL OUTPUT pages to make parallel connector input and output settings.

### PARALLEL INPUT page settings

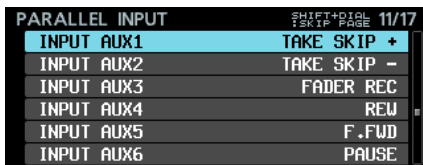

#### ■ INPUT AUX1 – INPUT AUX6

This shows the current functions set for INPUT AUX1 – INPUT AUX6 of the PARALLEL connector.

Select INPUT AUX1 – INPUT AUX6, and press the MULTI JOG dial to open the PARALLEL INPUT screen.

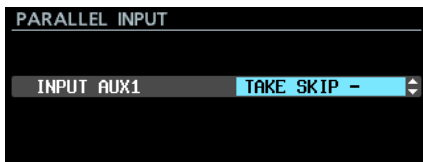

When INPUT AUX1 selected

INPUT AUX1 – INPUT AUX6 items

Set the functions for INPUT AUX1 – AUX6 of the PARALLEL connector.

Options:

- PLAY/PAUSE
- PAUSE (default for INPUT AUX6)
- REC
- FADER REC (default for INPUT AUX3)
- FADER START
- REW (default for INPUT AUX4)
- F.FWD (default for INPUT AUX5)
- TAKE SKIP - (default for INPUT AUX2)
- TAKE SKIP + (default for INPUT AUX1)
- MARK SKIP -
- MARK SKIP +
- TAKE/MARK SKIP -
- TAKE/MARK SKIP +
- MARK

#### NOTE

- Setting multiple FADER REC and FADER START settings to INPUT AUX is not possible.
- When set to FADER REC, low signal input starts recording and high signal input stops recording.
- When set to FADER START, low signal input starts playback and high signal input pauses playback.
- When set to anything other than the above, it operates with low signal input of 50 msec or longer. (See “Note about the PARALLEL connector” on page 12.)

## PARALLEL OUTPUT page settings

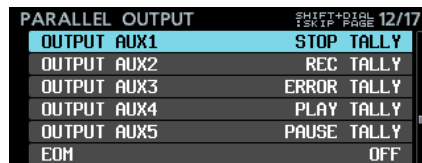

#### ■ OUTPUT AUX1 – OUTPUT AUX5

This shows the current functions set for OUTPUT AUX1 – OUTPUT AUX5 of the PARALLEL connector.

Select OUTPUT AUX1 – OUTPUT AUX5, and press the MULTI JOG dial to open the PARALLEL OUTPUT screen.

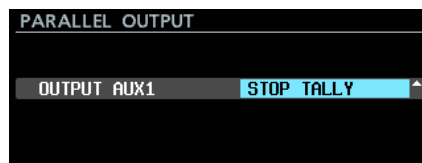

When OUTPUT AUX1 selected

OUTPUT AUX1 – OUTPUT AUX5 items

Set the functions for OUTPUT AUX1 – AUX5 of the PARALLEL connector.

Options:

- STOP TALLY (default for OUTPUT AUX1)
- PLAY TALLY (default for OUTPUT AUX4)
- PAUSE TALLY (default for OUTPUT AUX5)
- REC TALLY (default for OUTPUT AUX2)
- EOM TALLY
- ERROR TALLY (default for OUTPUT AUX3)
- EOM/ERROR TLLY

#### NOTE

When the INFO indicator is lit red, an ERROR TALLY signal is being output.

#### ■ EOM

This shows the setting status of the EOM (End Of Message) function.

If the available recording time (when recording or in recording standby) or the total remaining playback time (when playing back or in playback standby) becomes less than the set time, an EOM tally signal will be output from the pin number of the PARALLEL connector that corresponds to any OUTPUT AUX1 – OUTPUT AUX5 item set to EOM TALLY or EOM/ERROR TLLY.

Select the EOM item, and press the MULTI JOG dial to open the EOM screen.

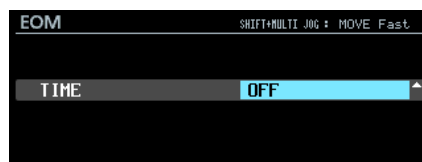

TIME item

Set the amount of time that will cause an EOM tally signal to be output.

Options: OFF (default), 1sec – 99sec (1sec increments)



## NOTE

When OUTPUT AUX1 – OUTPUT AUX5 is set to EOM/ERROR TLLY, a tally signal will be output when either condition is met.

## Network function settings

Use the NETWORK page to make network function settings.



### ■ MAC ADDRESS

This shows the unit's MAC address.

### ■ IP ADDRESS

This shows the current IP address setting mode.

### ■ DNS ADDRESS

This shows the current IP address setting mode for the DNS server.

### ■ IP SETUP

This shows the setting status of the MODE item on the IP SETUP screen.

Select the IP SETUP item, and press the **MULTI JOG** dial to open the IP SETUP screen.

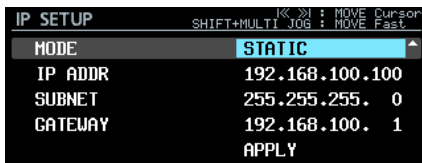

MODE item

Set the IP address setting mode.

Option	Meaning
STATIC (default)	Set the IP ADDR, SUBNET and GATEWAY items on the IP SETUP screen manually.
AUTO	Set the IP ADDR, SUBNET and GATEWAY items on the IP SETUP screen automatically. Use this setting if there is a DHCP server on the network.

IP ADDR, SUBNET and GATEWAY items

When the IP SETUP screen MODE item is set to STATIC, IP ADDR, SUBNET and GATEWAY items appear and their settings can be changed.

Options: 0 – 255

(IP ADDR item default: 192.168.100.100)

(SUBNET item default: 255.255.255.0)

(GATEWAY item default: 192.168.100.1)

When the MODE item is set to STATIC, press the **MULTI JOG** dial on APPLY in the last line to confirm the changed settings and return to the Menu Screen.

## NOTE

Press the EXIT [PEAK CLEAR] button to cancel the menu operation and return to the Menu Screen.

### ■ DNS SETUP

This shows the setting status of the MODE item on the DNS SETUP screen.

Select the DNS SETUP item, and press the **MULTI JOG** dial to open the DNS SETUP screen.

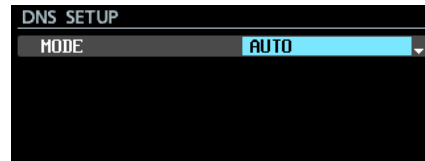

When the MODE item is set to AUTO



When the MODE item is set to STATIC

On the DNS SETUP screen, set the IP address of the DNS server so the IP address can be looked up from the server name.

MODE item

Set the IP address setting mode.

Option	Meaning
STATIC	Set the IP address of the DNS server manually.
AUTO (default)	Set the IP address of the DNS server automatically. Use this setting if there is a DHCP server on the network that will return the IP address of the DNS server.

DNS ADDR item

When the DNS SETUP screen MODE item is set to STATIC, a DNS ADDR item appears and its setting can be changed.

Options: 0 – 255 (default: 0.0.0.0)

When the MODE item is set to STATIC, press the **MULTI JOG** dial on APPLY in the last line to confirm the changed settings and return to the Menu Screen.

## NOTE

Press the EXIT [PEAK CLEAR] button to cancel the menu operation and return to the Menu Screen.

### ■ PASSWORD

Select the PASSWORD item, and press the **MULTI JOG** dial to open the PASSWORD screen.



Set the password (default: DA-6400).

Use up to 10 characters.

For details about how to edit the text, see “Editing text” on page 26.

## NOTE

Press the **MULTI JOG** dial on PRESET ▲ to input “DA-6400”.

# 7 – Internal Settings

## Setting the SNTP function

Use the SNTP page to make settings for automatically synchronizing with the date and time of an Internet time server.

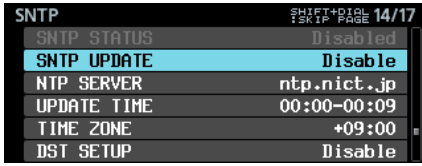

### ■ SNTP STATUS

This shows the current status of the SNTP function.

Message	Status
Sync at YYYY/MM/DD hh:mm	The unit will be synchronized with the NTP server at the date and time shown.
Starting Up	The unit is preparing for operation.
Accessing Server	The unit is connecting with a server.
Disabled	The SNTP function is disabled.
Waiting for Network	The unit is waiting to confirm the network connection.
Server Name not found	The server name could not be found on the DNS server.
Server Name found	The server name was found on the DNS server.
Server connection failed	The server has not responded.
Server refusing connections	Server responded, but is refusing additional connections; select a different SNTP server

### ■ SNTP UPDATE

This shows the setting status of the MODE item on the SNTP UPDATE screen.

Select the SNTP UPDATE item, and press the **MULTI JOG** dial to open the SNTP UPDATE screen.

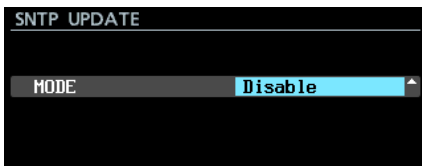

#### MODE item

Set the SNTP function update mode.

#### Options

**Disable** (default): Do not use SNTP function.

**Start UP**: When the unit starts up, get the time from an NTP server and use it to set the built-in clock.

**Start UP/24h cycle**: Get the time from an NTP server and use it to set the built-in clock when the unit starts up, as well as when the time set with the UPDATE TIME item occurs every 24 hours.

### NOTE

When using the SNTP function, you must set the NTP Server item and the NETWORK page DNS SETUP item.

### ■ NTP SERVER

This shows the setting status of the NTP SERVER screen.

Select the NTP SERVER item, and press the **MULTI JOG** dial to open the NTP SERVER screen.



Edit the NTP server name, which must have no more than 32 characters (default: ntp.nict.jp).

For details about how to edit the text, see “Editing text” on page 26.

### NOTE

Press the **MULTI JOG** dial on **PRESET ▲** to open a pull up menu.



Turn the **MULTI JOG** dial to select a menu item, and press the **MULTI JOG** dial to input the preset value of that item.

Press the **EXIT [PEAK CLEAR]** button to close the pull-up menu.

### ■ UPDATE TIME

This shows the setting status of the Time item on the UPDATE TIME screen.

Select the UPDATE TIME item, and press the **MULTI JOG** dial to open the UPDATE TIME screen.



#### Time item

If the **MODE** item on the SNTP UPDATE screen is set to **Start UP/24h cycle**, set the time when the time will be acquired from the NTP server.

Options: 00:00-00:09 – 23:00-23:09 (in 1-hour steps, default: “00:00-00:09”)

### NOTE

Since access to SNTP servers on the hour could result in congestion, the unit will access the SNTP server randomly during the first 10 minutes of the hour.

## ■ TIME ZONE

This shows the setting status of the Time Zone item on the TIME ZONE screen.

Select the TIME ZONE item, and press the **MULTI JOG** dial to open the TIME ZONE screen.

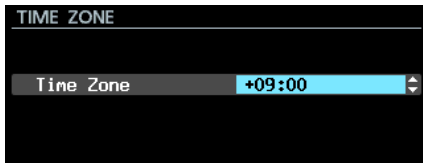

### Time Zone item

Set the time offset from Coordinated Universal Time (UTC).

Options: -12:00 - +14:00 (00:15/step, default: +09:00)

## NOTE

- For the United States, use one of the following settings.

Zone	Setting
Pacific Standard Time (PST) zone	-08:00
Mountain Standard Time (MST) zone	-07:00
Central Standard Time (CST) zone	-06:00
Eastern Standard Time (EST) zone	-05:00

- To use Japan Standard Time (JST), set this to +09:00.

## ■ DST SETUP

This is the settings screen for the daylight savings time function, which advances the built-in clock during the set period.

It shows the setting status of the MODE item on the DAYLIGHT SAVING TIME screen.

Select the MODE item, and press the **MULTI JOG** dial to open the MODE screen.



When MODE is set to Disable

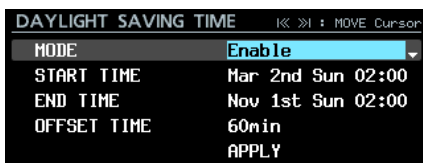

When MODE is set to Enable

### MODE item

Set whether or not to enable the daylight savings time function.

Options

Disable (default): Do not use the daylight savings time function.

Enable: Use the daylight savings time function.

### START TIME/END TIME items

Set when to start and end use of the daylight savings time function.

Setting item	Options
Month	Jan, Feb, Mar, Apr, May, Jun, Jul, Aug, Sep, Oct, Nov, Dec
Week	1st, 2nd, 3rd, 4th, 5th, Last
Day	Sun, Mon, Tue, Wed, Thu, Fri, Sat
Time	00:00 - 24:00 (01:00/step)

START TIME defaults: Mar/2nd/Sun/02:00

END TIME defaults: Nov 1st Sun 02:00

### OFFSET TIME item

Set the amount to advance the clock during daylight savings time.

Options: 30min, 60min (default)

## NOTE

On the screen, local time is set, not Coordinated Universal Time (UTC).

When the MODE item is set to Enable, press the **MULTI JOG** dial on APPLY in the last line to confirm the changed settings and return to the Menu Screen.

## NOTE

Press the EXIT [PEAK CLEAR] button to cancel the menu operation and return to the Menu Screen.

# 7 – Internal Settings

## Network functions (FTP server/telnet/VNC)

### FTP (file transfer protocol) server

By using an FTP client function, you can transfer files between this unit and a computer. Connect to this unit and log in as you would with another FTP server.

When you connect and log in, "ssd" and "usb0" will appear in the root directory. These directories are SSD/HDD and USB.

If the corresponding media is not loaded, nothing will appear beneath "ssd" and "usb0".

#### NOTE

- *Data in files and folders with names that use Japanese or other multibyte characters cannot be displayed or transferred properly. When using the FTP function, use only half-width alphabetical letters, numbers and symbols (ASCII characters) in file and folder names.*
- *For information about FTP client applications that have already been confirmed to work with this unit, please contact TASCAM customer support (contact information at the end of this manual).*

### Required settings for FTP connection

The following settings are necessary to connect to this unit by FTP.

IP address: The IP address of the unit is shown in the IP ADDRESS item on the NETWORK page.

Port number: 21

User name: DA-6400

Case-sensitive (cannot be changed)

Password: DA-6400 (default) (Case-sensitive)

This can be changed on the PASSWORD screen.  
(See "Network function settings" on page 39.)

#### NOTE

- *FTP connection is not possible when the EXTERNAL CONTROL item is set to LOCK on the LOCK SETUP screen.*
- *If the setting is changed to LOCK when there is an FTP connection, the connection will be interrupted.*
- *If a NETWORK page setting is changed when there is an FTP connection, the connection will be interrupted.*

### Overview of file operations using an FTP client application

1. Reading files from the unit  
Reading files from the unit is always possible.
2. Adding new files to the unit  
Adding new files to the unit is always possible.  
If BWF or WAV files are added to the current folder during recording, files will be shown in the list in order from existing files to recorded files and then added files.
3. Overwriting existing files on the unit  
The current take can only be overwritten when the unit is stopped.  
Overwriting all other existing files on the unit is always possible. However, if the MODE item on the PLAY MODE screen is set to ALL and the unit is playing, overwriting the take after the current take might not be possible depending on the timing. (See "Setting the play mode" on page 35.)

#### CAUTION

- *Problems might occur if the size, number of channels, bit depth or sampling frequency of the overwritten file differs from the original file.*

*The following error message will appear if playback is attempted when the problem has occurred.*

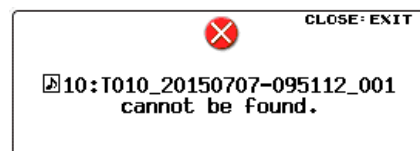

*Delete that take from the SSD/HDD to resolve the problem and stop the error message from appearing.*

- *Do not overwrite existing audio files with files that use different sampling frequencies. Doing so could make it impossible to resolve the problem*
4. Deleting files on the unit  
The current take can only be deleted when the unit is stopped.  
Files other than the current take can be deleted at any time. You must rebuild after deleting a file, however, because discrepancies between management and audio files will occur.
    - After deleting a file (and after playback/recording stops), when the following rebuild confirmation message appears, execute rebuilding.

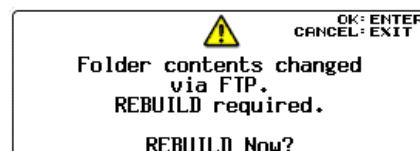

- If you do not rebuild, discrepancies between the management and audio files will occur, and the following message might appear.



- When rebuilding becomes necessary, the **INFO** indicator will light red and the following pop-up message will appear.

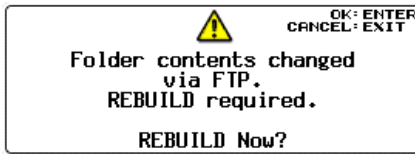

Press the **MULTI JOG** dial to rebuild.

Press the **EXIT [PEAK CLEAR]** button to close the pop-up message.

- When rebuilding becomes necessary and the **INFO** indicator lights red, press the **INFO** button to open an ALERT INFORMATION pop-up message like the following.

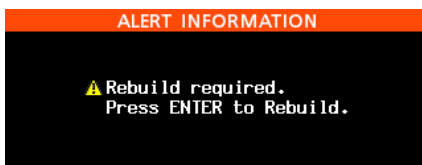

When this appears, press the **MULTI JOG** dial to open a rebuild confirmation pop-up message. Press the **MULTI JOG** dial again to rebuild.

Press the **EXIT [PEAK CLEAR]** button to close the pop-up message.

- When rebuilding becomes necessary, an icon will appear in the following locations. Select the **REBUILD** item in the **BROWSE** screen pull-up menu to rebuild.
  - At the right side of the **BROWSE** item on the **GENERAL** menu page.



- At the top right of the **BROWSE** screen. **REBUILD REQUIRED** appears to the right of the icon.



- To the right of the **REBUILD** item in the **BROWSE** screen pull-up menu.



- Adding new folders to the unit  
Adding new folders to the unit is always possible.
- Deleting folders on the unit  
The current folder can only be deleted when the unit is stopped.

Folders other than the current folder can be deleted at any time.

- Change the names of files and folders on the unit  
The names of files and folders on the unit cannot be changed.

### NOTE

*FTP transfer with USB flash drives is only possible when the unit is stopped. Do not edit, load folders, skip or conduct other operations.*

## Remote control (Telnet)

Remote control of this unit by Ethernet using Telnet through port 23 is possible.

- Required settings for Telnet connection  
The following settings are necessary to connect to this unit by Telnet.

IP address: The IP address of the unit is shown in the IP ADDRESS item on the **NETWORK** page.

Port number: 23

Password: DA-6400 (default) (Case-sensitive)

This can be changed on the **PASSWORD** screen. (See “Network function settings” on page 39.)

- Connecting to this unit by Telnet
  - After connecting to this unit by Telnet with the above IP address and port number, press the computer Enter key.
  - “Enter Password” will appear on the Telnet console. Enter the above password and press the Enter key.
  - When login succeeds, “Login Successful” will appear on the Telnet console. Enter “exit” and press the Enter key to end the Telnet connection.

### NOTE

- Two Telnet connections are possible at the same time.
- Telnet connection is not possible when the **EXTERNAL Control** item is set to **LOCK** on the **LOCK SETUP** screen. If the setting is changed to **LOCK** when there is a Telnet connection, the connection will be interrupted.
- If a **NETWORK** page setting is changed when there is a Telnet connection, the connection will be interrupted.
- For information about this unit's Telnet command protocol, please contact TASCAM customer support (contact information at the end of this manual).

## 7 – Internal Settings

### VNC (virtual network computing)

By using a VNC viewer application, you can view and operate the screen shown on this unit's display from a computer.

The following operations are possible using a mouse with a VNC viewer application.

- Mouse left click: Same function as pressing the unit's **MULTI JOG** dial
- Mouse right click: Same function as pressing the unit's **EXIT [PEAK CLEAR]** button
- Mouse wheel operation: Same function as turning the unit's **MULTI JOG** dial
- Mouse wheel press and turn: Same function as turning the unit's **MULTI JOG** dial while pressing and holding the **SHIFT** button to make rough setting changes (MOVE Fast operation).

In addition, when the VNC viewer application is active, the computer keyboard can be used for the same operations as though it were connected directly to the unit. See "List of keyboard operations" on page 54 for details.

#### ■ Required settings for VNC connection

The following settings are necessary to connect to this unit by a VNC viewer application.

IP address: The IP address of the unit is shown in the **IP ADDRESS** item on the **NETWORK** page.

Password: DA-6400 (default) (Case-sensitive) This can be changed on the **PASSWORD** screen. (See "Network function settings" on page 39.)

#### NOTE

- *Only one VNC connection is possible at a time.*
- *When the **KEYBOARD** item is set to **LOCK** on the **LOCK SETUP** screen, a VNC viewer application can be used to view the unit's display but it cannot be used to control the unit.*
- *If a **NETWORK** page setting is changed when there is a VNC connection, the connection will be interrupted.*
- *For information about VNC viewer applications that have already been confirmed to work with this unit, please contact TASCAM customer support (contact information at the end of this manual).*
- *When files are being transferred by FTP or the system uses 88.2/96kHz sampling frequency, the appearance and operation of the VNC viewer application will not be smooth.*

### Making oscillator settings

A 1kHz sine wave is output at the reference level (See "Setting the reference level" on page 23.).

Use this to check connections, for example.

1. Select the **OSCILLATOR** item on the **SYSTEM SETUP** page to open the **OSCILLATOR** screen. (See "Menu operation procedures" on page 16.)

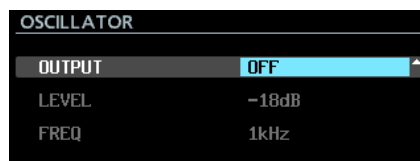

2. Turn the oscillator on or off.  
Options: **OFF** (default value), **ON**
3. Confirm the setting and return to the Menu Screen.

#### NOTE

- *If you change the reference level on the **REFERENCE LEVEL** screen, the oscillator output level will also change.*
- *The reference level cannot be changed on this screen.*
- *The frequency is fixed at 1kHz.*
- *The oscillator ON setting is not backed up.*
- *The oscillator cannot be turned ON during playback.*
- *The oscillator will automatically be turned OFF at the following times.*
  - During startup
  - When loading a folder
  - When playback starts



# 8 – Mark and Locate Functions

## Mark functions

### Adding marks

Marks can be added in the following ways.  
Including the marks added by the automatic mark function, one take can have up to 99 marks added to it.

#### ■ Adding marks manually

Press the **MULTI JOG** dial to add a mark at the current playback/recording point.

The mark will be named "MARK xx".



#### ■ Adding marks automatically

The automatic mark function allows the unit to add marks automatically during recording. For details about the automatic mark function, see "Adding marks automatically when recording" on page 27.

The marks will be named according to type.

Reason mark added automatically	Mark name
Overload indicator lit	OVERxx
Synchronization with master clock lost	UNLKxx
At set time interval	TIMExx

### Using marks

Press the **INFO** button while pressing and holding the **SHIFT** button to open the **MARK INFO** page.

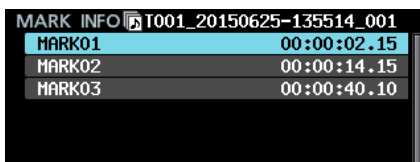

No Mark Point is shown when the current take has no marks.

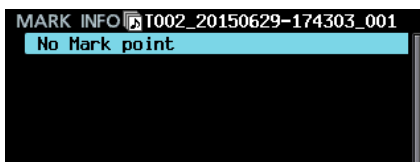

Select the desired mark on the **MARK INFO** Screen and press the **MULTI JOG** dial to open the mark pop-up menu.

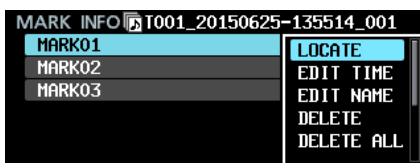

Turn the **MULTI JOG** dial to select the desired item, and press the **MULTI JOG** dial to execute it as follows.

#### ■ LOCATE

Move to the selected mark. (See "Moving to marks" on page 45.)

#### ■ EDIT TIME

Open the **EDIT MARK TIME** screen where you can edit the selected mark.

#### ■ EDIT NAME

Open the **MARK NAME** screen where you can edit the name of selected mark.

#### ■ DELETE

Delete the selected mark. (See "Deleting marks" on page 46.)

#### ■ DELETE ALL

Delete all marks in the current take. (See "Deleting all marks in the current take" on page 46.)

#### ■ SORT BY TIME

Show marks sorted by time.

#### ■ SORT BY NAME

Show marks sorted by name.

#### ■ INFO

Open a pop-up with the number of marks of each type in the current take. (See "Viewing mark information" on page 46.)

#### ■ CANCEL

Close the mark menu.

## Moving to marks

#### ■ Using buttons to move to marks

Press the **◀◀ [MARK ◀◀]** or **▶▶ [MARK ▶▶]** button while pressing and holding the **SHIFT** button to move to the previous or next mark.

#### NOTE

*If the settings of the INPUT AUX1-INPUT AUX6 items are MARK SKIP +, MARK SKIP -, TAKE/MARK SKIP +, TAKE/MARK SKIP - or MARK on the PARALLEL INPUT screen, if a mark movement event is input through the PARALLEL connector, the transport will move one mark backward or forward for each event. (See "PARALLEL INPUT page settings" on page 38.)*

#### ■ Using the menu to move to marks

1. Turn the **MULTI JOG** dial to select the mark to which you want to move.
2. Press the **MULTI JOG** dial to open the mark pop-up menu, select the **LOCATE** item and press the **MULTI JOG** dial to move to the selected mark.

# 8 – Mark and Locate Functions

## Editing mark names

1. Select the mark with the name that you want to edit and press the **MULTI JOG** dial to open the mark pop-up menu.
2. Select the **EDIT NAME** item in the mark menu, and press the **MULTI JOG** dial to open the **MARK NAME** screen.



3. Input the mark name.  
For details about how to edit the mark name, see “Editing text” on page 26.

### NOTE

- The names of marks created by the automatic mark function cannot be changed.
- Editing the names of marks is only possible when stopped or in playback standby.

## Deleting marks

1. Select the mark that you want to delete and press the **MULTI JOG** dial to open the mark pop-up menu.
2. Select the **DELETE** item in the mark menu, and press the **MULTI JOG** dial.
3. A confirmation pop-up message will appear.  
Press the **MULTI JOG** dial again to open a second confirmation pop-up message.
4. Press and hold the **MULTI JOG** dial to delete the selected mark.

### NOTE

Deleting marks is only possible when stopped or in playback standby.

## Deleting all marks in the current take

1. Press the **MULTI JOG** dial to open the mark pop-up menu.
2. Select the **DELETE ALL** item in the mark menu, and press the **MULTI JOG** dial.
3. A confirmation pop-up message will appear.  
Press the **MULTI JOG** dial again to open a second confirmation pop-up message.
4. Press and hold the **MULTI JOG** dial to delete all marks in the current take.

### NOTE

Deleting marks is only possible when stopped or in playback standby.

## Editing mark locations

You can edit the position (time) of a mark added using the **MULTI JOG** dial (a mark named “MARK xx”).

### NOTE

- The names of marks created by the automatic mark function cannot be changed.
  - Editing the locations of marks is only possible when stopped or in playback standby.
1. Select the mark with the location that you want to edit and press the **MULTI JOG** dial to open the mark pop-up menu.
  2. Select the **EDIT TIME** item in the mark menu, and press the **MULTI JOG** dial.
  3. When the **EDIT MARK TIME** screen opens, use the **MULTI JOG** dial to change the time.



Press the **MULTI JOG** dial when the cursor is in the last field to confirm the setting and return to the **MARK INFO** screen.

### NOTE

- When editing, you can press the **EXIT [PEAK CLEAR]** button to cancel the changes and return to the **MARK INFO** screen.
- You can also use a USB keyboard to input numbers.

## Viewing mark information

Press the **MULTI JOG** dial to open the mark pop-up menu, select the **INFO** item and press the **MULTI JOG** dial again to show the numbers of marks of different types in the current take.

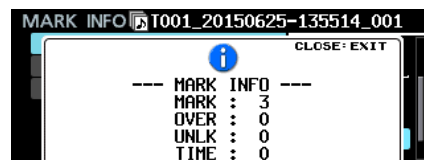

Press the **EXIT [PEAK CLEAR]** button to close the pop-up message.

## Locating to a specific time

You can locate to a specific time using a USB keyboard with a numeric keypad or a USB numeric keypad.

Press the \* (asterisk) key on the Home Screen to clear the take number and time display and enable numerical input.

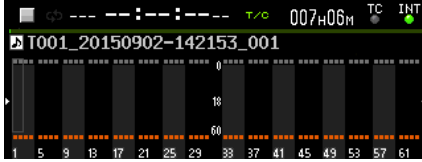

Use the keypad to enter numbers in the following order.

- Take number: 3 digits
- Time elapsed from take beginning (hours, minutes, seconds, frames): 2 digits each

For example, enter the following numbers in order to specify the location 1 minute 30 seconds from the beginning of take 2.

0 → 0 → 2 → 0 → 0 → 0 → 1 → 3 → 0 → 0 → 0

After inputting the 11th digit, the unit will automatically locate to the specified time.

The status of the unit after locating will be the same as it was before (stopped, in playback standby or playing).

For this reason, playback will resume at the new time only after locating during playback.

### NOTE

*Using the Backspace or / key on the USB keyboard will delete the last input number.*

## Locating before completely specifying the time

Before inputting all the numbers to specify a time, you can press the Enter key on the USB keyboard, the **MULTI JOG** dial on the unit or the ► or || [CHASE] button to locate to the time specified.

For example, entering the following incomplete time.

0 → 0 → 2 → 0 → 0 → 1 → 2

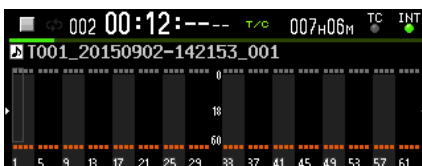

Press the ► button to locate to 12 minutes from the beginning of take 2.

What happens after locating depends on which control was pressed.

### ■ If the MULTI JOG dial was pressed:

Playback or playback standby is resumed according to the state before locating.

### ■ If the ► button was pressed:

Playback starts.

### ■ If the || [CHASE] button was pressed:

The unit enters playback standby.

# 9 – Loading Files Recorded by Other Devices

The unit can load audio files that meet the following conditions and play them as takes. Moreover, the unit can load audio files that were created by a TASCAM DA-6400/DA-6400dp and meet the following conditions and play them as is.

- File formats: BWF, WAV
- Sampling frequencies: 44.1, 48, 88.2, 96 kHz
- Quantization bit depth: 16/24-bit
- Number of channels: 1

## CAUTION

*Takes with sampling frequencies that are different from that set on the REC F $\Sigma$  screen cannot be played back. (See “Setting the recording file format” on page 25.)*

*To play takes with sampling frequencies that are different, change the setting on the REC F $\Sigma$  screen.*

*We recommend that you keep only files with the same sampling frequency together in a folder whenever possible.*

## NOTE

- *This unit recognizes and groups up to 64 mono WAV files together as a single take if they have file names in the format “[name]\_[2-digit channel number].wav”.*
- *If the channel number has one digit, a “0” will be added to the beginning of the number, resulting in “01” and “02”, for example.*
- *If the 2-digit channel number is “65” or higher in the name of a WAV file, it will be recognized as a single take.*
- *If the name of a WAV file does not have a 2-digit channel number, it will be recognized as a single take.*

## Preparation before loading

If an SSD or HDD drive is to be used with this unit for the first time, use this unit to format it. SSD and HDD drives formatted by this unit are optimized to improve performance.

Operation of this unit might be affected when using an SSD/HDD that has been formatted by a computer or other device.

1. Format the SSD/HDD drive. (See “Preparing SSD/HDD drives and USB flash drives for use” on page 19.)

## NOTE

*When this unit formats a drive, it automatically puts a “DA Files” folder in the root directory.*

2. You can connect the drive to a computer or other device by switching the unit to USB connection mode or turning the unit off and removing the SSD/HDD case. (See “Connecting an SSD/HDD to a computer” on page 49.)
3. If formatted by this unit, a drive named “DA-6400” should be recognized by the computer.
4. Copy the audio files you want to load into folders on the DA-6400 drive.
5. When done copying, end USB connection mode or disconnect the SSD/HDD case from the computer.

## Using the loaded files on the unit

- If they were added to the current folder, audio files that can be played back will automatically be recognized as takes.
- If they were added to any other folder, when that folder is selected as the current folder, audio files that can be played back will automatically be recognized as takes.

# 10 – Data Transfer Using a Computer

By using a USB cable to connect the SSD/HDD case installed in this unit to a computer, you can transfer data between them and check the folder and file structure.

Changing or deleting files inside folders, or changing their names, however, might make it impossible for the DA-6400 to play back those folders. Be aware of this possibility.

## ■ Warning about copying files to computers

Be aware of the following precaution when copying files from a DA-6400 SSD/HDD to a computer.

- If you want to be able to play files properly on a DA-6400 at a later date, copy complete folders and do not change their structures.

Changing the folder structure or copying just BWF/WAV files could make it impossible for the DA-6400 to play files back properly with, for example, the correct number of channels and take numbers.

## ■ Warning about copying files from computers

Be aware of the following precaution when copying files from a computer to a DA-6400 SSD/HDD.

- The DA-6400 can only play linear PCM WAV files with sampling frequencies of 44.1, 48, 88.2 or 96 kHz and bit depths of 16/24-bit. The DA-6400 cannot recognize files other than WAV files and will ignore them.
- Files with different sampling frequencies mixed together in the same folder can be recognized as takes. Takes with sampling frequencies that are different from that set on the **REC F** screen, however, cannot be played back. We recommend that you only keep files with the same sampling frequency together in a folder whenever possible. (See "Setting the recording file format" on page 25.)
- Do not copy files larger than 2 GB to a DA-6400 SSD/HDD. Doing so could cause operation of the DA-6400 to become unstable and damage files on the SSD/HDD.

## NOTE

*The expression "computer" in the explanations in this chapter refers to a Windows or Mac computer that this unit supports.*

## Computer system requirements

This unit can be connected to the following types of computers.

### ■ Windows

Windows 10, Windows 8 (including 8.1), Windows 7

### ■ Mac

Mac OS X 10.2 or newer

When this unit and a computer are connected, the computer will recognize this unit as a removable disk. No special driver is necessary.

## NOTE

*Data is transferred between the SSD/HDD case and computer at USB 3.0 speed (maximum). In order to achieve USB 3.0 speed, you must use the included USB cable or a commercially-available USB 3.0 (microB) cable and connect to a port on the computer that supports USB 3.0.*

## Connecting an SSD/HDD to a computer

By connecting the SSD/HDD case installed in this unit to a computer, you can transfer audio data recorded by this unit to the computer.

Use the USB 3.0 port to connect the SSD/HDD case and a computer.

1. Use the included USB cable to connect the SSD/HDD case to a computer in the order shown in the following illustration (① → ② → ③).

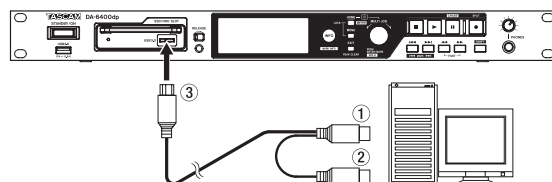

2. On the **MEDIA** page, select the **SSD/HDD USB CONNECT** item.
3. Press the **MULTI JOG** dial to open a confirmation pop-up message.
4. Press the **MULTI JOG** dial.

The following pop-up message will appear.

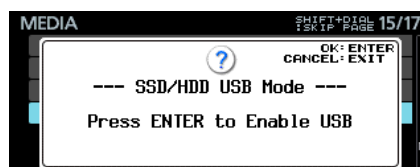

5. Press the **MULTI JOG** dial to start the connection with the computer. The following screen appears when connected to a computer.

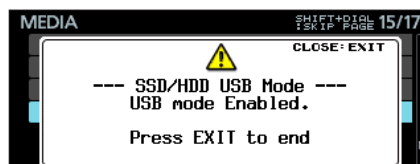

## ■ Precautions when connecting an SSD/HDD case and a computer

- Connect both type A connectors (①, ②) on the included USB cable to the computer. Depending on the power supply capacity of the computer's USB ports and the type of SSD/HDD drive installed in the case, the power supply could be insufficient and the drive might not function properly.
- Connect both type A connectors (①, ②) on the included USB cable to the computer first. Then, connect the USB 3.0 microB connector (③) to the SSD/HDD case.
- Do not connect the type A connectors (①, ②) on the included USB cable to an AC adapter or any 5V power supply device other than the computer. Connecting to a power supply device besides the computer could damage all the equipment connected to the cable.

# 10 – Data Transfer Using a Computer

## Disconnecting from a computer

Follow these procedures to disconnect from a computer.  
Failure to follow the procedures could damage some files.  
Always follow these procedures to disconnect.

### CAUTION

*Do not end the USB connection or disconnect the USB cable during data transfer.*

*Doing so could damage data on the computer or the unit.*

1. End the connection from the computer.

Follow these procedures to disconnect individual SSD/HDD drives.

Disconnecting from Windows 10, Windows 8 (including 8.1), Windows 7

If you click “Safely Remove Hardware” in the taskbar system tray (usually at the bottom right) to disconnect the hardware, the DA-6400 SSD/HDD case itself will be disconnected.

Disconnecting from Mac

Drag the unit's DA-6400 icon to the trash or type Command+E to eject the DA-6400.

At this point, the SSD/HDD can be removed from the case. You can put another SSD/HDD into the case now if desired.

### NOTE

- *If you want connect it with the computer again after disconnecting, disconnect and reconnect the USB cable.*
  - *Depending on the Mac OS X version, you can also eject the DA-6400 by clicking the eject icon next to its name in a Finder window or using a control key operation.*
2. End the connection from the unit.  
Press the **EXIT [PEAK CLEAR]** button to end the connection with the computer from the unit. The following pop-up message will appear in such cases.

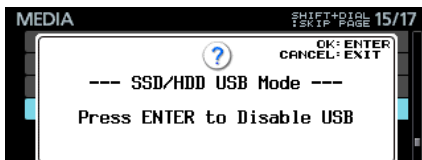

Press the **MULTI JOG** dial to end the connection with the computer and reopen the Menu Screen.

Press the **EXIT [PEAK CLEAR]** button to return to the pop-up message that appears when connected.

3. Disconnect the USB cable.

### NOTE

*Even when an SSD/HDD case has been removed from the unit, it can still be connected to a computer and exchange data with it.*



# 11 – Other Settings, Information Screens and Keyboard Operations

## INFO button and indicator appearance

The **INFO** indicator lights blue when the unit is functioning properly.

The **INFO** indicator lights red when an error or warning has occurred with the unit.

Press this button when the **INFO** indicator is lit blue to show the unit's operation status on the display. Press this button when the **INFO** indicator is lit red to show the error message on the display.

### ■ Operation status display (when lit blue)

INFORMATION	
CLOCK	48kHz INTERNAL
FILE	BWF 24bit 64ch MONO 2015/02/14

Contents

#### CLOCK

Sampling frequency and clock source currently used for operation

#### FILE

Information about currently selected file

File type/quantization bit depth

Number of channels/file mode

Recording date

When lit blue, press the **INFO** button to switch between the Home Screen and operation status display.

### ■ Alert display (when lit red)

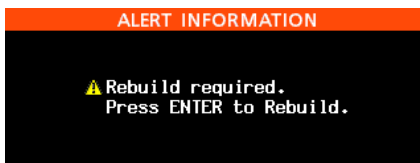

Contents 1

Rebuilding is necessary. Press the **MULTI JOG** dial to rebuild.

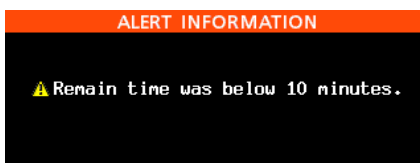

Contents 2

The remaining recording time is less than 10 minutes. This appears when the remaining recording time becomes less than 10 minutes when recording or in recording standby.

Once this alert has been viewed, it will not appear again until recording ends.



Contents 3

Due to the increased number of files in a folder, for example, writing to the media has become slower so the recording buffer is about to overflow. Reduce the number of recording channels or create a new folder.

These messages could be shown at the same time.

### ■ Error display 1 (when lit red)



Contents

This shows media errors.

For the DA-6400dp, this also shows power supply errors. (See "Setting the power redundancy check function (DA-6400dp only)" on page 55.)

### ■ Error display 2 (when lit red)



Contents

This shows master clock and slot errors.

Press the **INFO** button to cycle through the screens in this order: alert, error 1, error 2, operation status, Home Screen.

Alert and error screens, however, will only be shown when one has occurred (when lit red).

## Checking the firmware version

1. Select the **VERSION INFO** item on the **SYSTEM SETUP** page to open the **VERSION INFORMATION** screen. (See "Menu operation procedures" on page 16.)

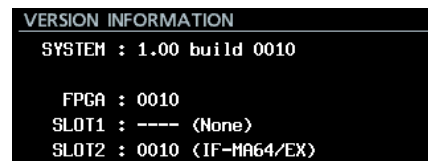

On the **VERSION INFORMATION** screen, information is shown about the system firmware version and build number, as well as cards installed in **SLOT 1** and **SLOT 2**.

2. Press the **EXIT [PEAK CLEAR]** button to return to the Menu Screen.

# 11 – Other Settings, Information Screens and Keyboard Operations

## Firmware update procedures

1. Download the latest firmware from the TEAC Global Site (<http://teac-global.com/>). If the downloaded file is in ZIP format or another compressed file type, decompress it.
2. Copy the downloaded firmware to the root directory (top level) of a USB flash drive.
3. Insert the USB flash drive prepared in step 2 into the **USB2.0** port on the front of the unit.
4. Select the **F/W UPDATE** item on the **SYSTEM SETUP** page to open the **Firmware update** screen. (See “Menu operation procedures” on page 16.)

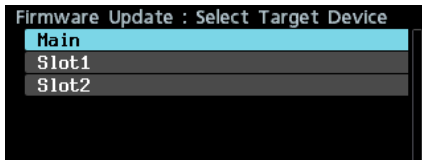

5. Select the device to be updated.

### Options

**Main:** Update the firmware of the main unit

**Slot1:** Update the firmware of the I/O card installed in **SLOT 1**

**Slot2:** Update the firmware of the I/O card installed in **SLOT 2**

6. When the USB flash drive and firmware update file have been verified, the following screen will appear.

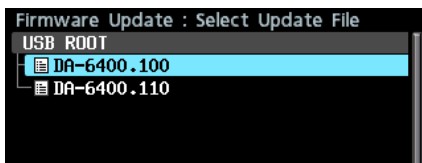

### NOTE

- The screen above shows a list of firmware update files in the root folder of the USB flash drive connected to the **USB2.0** port on the front of the unit. The firmware copied in step 2 above should also be shown.

No Update File is shown if no update file is in the directory.

- A maximum of five lines of firmware can be shown at the same time. If there are more files than this, use the **MULTI JOG** dial to scroll the list.

- The screen shown above is an example. The actual appearance will differ.

7. Select the firmware update to use.

The screen shown below will appear.

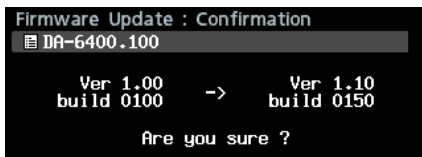

The number of the current version is shown on the left and the update version is shown on the right.

### NOTE

The screen shown above is an example. The actual appearance will differ.

8. Press the **MULTI JOG** dial to start the update.

### CAUTION

- Be careful not to let the power be interrupted during the update.
  - If the power is interrupted during the update, the unit might become unstartable.
9. When the update completes, the following screen will appear.

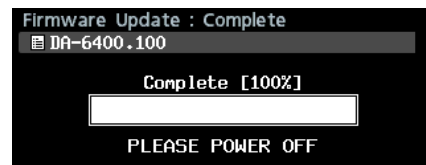

10. Press the **STANDBY/ON** switch on the unit to turn it off.
11. Refer to “Checking the firmware version” on page 51 and confirm that the latest firmware is being used. This completes the update procedure.
12. Delete the firmware update file from the USB flash drive.

## Viewing media information

You can view information about the current device's media.

1. Select the **MEDIA INFO** item on the **MEDIA** page to open the **MEDIA INFO** screen.



2. Select the media that you want to check, and open the media information pop-up.

You can view information about the current device's media, and check its used space, open space and total size.



3. Press the **EXIT [PEAK CLEAR]** button to return to the Menu Screen.

# 11 – Other Settings, Information Screens and Keyboard Operations

## Setting peak hold time

You can set the level meter peak hold time.

1. Select the **PEAK HOLD TIME** item on the **PREFERENCES** page to open the **PEAK HOLD TIME** screen. (See “Menu operation procedures” on page 16.)



2. Set the level meter peak hold time.  
Options: 0sec – 10sec, inf (hold never disappears) (default: 2sec)
3. Confirm the setting and return to the Menu Screen.

### NOTE

When the Home Screen is open, you can press the **EXIT [PEAK CLEAR]** button to reset peak holds.

## Setting the meter mode

Set the number of level meter channels shown in the level meter area of the Home Screen.

1. Select the **METER MODE** item on the **PREFERENCES** page to open the **METER MODE** screen. (See “Menu operation procedures” on page 16.)

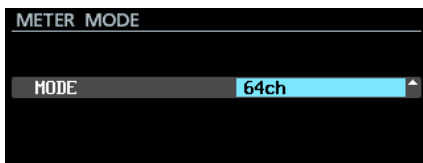

2. Set the number of level meter channels shown in the level meter area of the Home Screen.  
Options: 32ch, 64ch (default)
3. Confirm the setting and return to the Menu Screen.

### NOTE

- When the meter mode is set to 32ch, the Home Screen will appear as shown below.



Press the **HOME [METER]** button while pressing and holding the **SHIFT** button to switch between showing level meters for channels 1-32 and 33-64 on the Home Screen.

- When switching between showing channels 1-32 and 33-64 and the meter mode is “32ch”, the position of the solo selection frame before switching will be retained. For this reason, the solo selection frame will become hidden. In this case, use the **MULTI JOG** dial to move the solo selection frame to a visible channel.
- When the meter mode is “32ch”, the solo selection frame can only be moved to visible channels.

## Using a USB keyboard to operate the unit

You can connect a Windows-compatible USB keyboard or numeric keypad to the **USB2.0** port on the front of the unit, and use it to control the unit.

Various controls are possible, but it makes inputting text much more efficient.

## Setting the keyboard type

Set the type of keyboard being connected.

1. Select the **KEYBOARD TYPE** item on the **PREFERENCES** page to open the **KEYBOARD TYPE** screen. (See “Menu operation procedures” on page 16.)



2. Set it to **US** (English-language keyboard) or **JPN** (Japanese keyboard).  
Options: JPN (default), US
3. Confirm the setting and return to the Menu Screen.

## Using the keyboard to input names and values

You can edit and input characters for the following items in the same way as with a computer.

- Folder names (See “Creating new folders” on page 33.)
- File names (See “Editing folder, take and file names” on page 31.)
- Passwords (See “Network function settings” on page 39.)
- NTP server names (See “Setting the SNTP function” on page 40.)
- Mark names (See “Editing mark names” on page 46.)

You can also input numbers for the following item.

- Locating to a specific time (See “Locating to a specific time” on page 47.)

### ■ Selecting the type of character input:

Use the **Shift** and **Caps Lock** keys to change the type of character input in the same way as with a computer.

### ■ Inputting characters:

Use the number, character and symbol keys to input characters directly.

### ■ Moving the cursor:

Use the **←/→** keys.

Use the **HOME/↑** key to move the cursor to the beginning.

Use the **END/↓** key to move the cursor to the end.

# 11 – Other Settings, Information Screens and Keyboard Operations

## ■ Deleting a character:

Delete key: delete character at cursor  
Back Space key: delete character before cursor

## ■ Inserting characters:

Input the character at the desired position (default: insert mode).

If the character input mode is not set to the default insert mode, press the Insert key to switch to insert mode before inputting characters.

## ■ Correcting characters:

Press the Insert key to switch to overwrite mode, move the cursor and input the correct character.

### CAUTION

- *The following symbols and punctuation marks cannot be used in text.*  
¥ / : \* ? “ < > |
- *Japanese characters cannot be input.*

You can also input values for the following items.

EDIT TAKE TC screen (See page 33)  
EDIT MARK TIME screen (See page 46)  
GENERATOR USER BITS screen (See page 36)  
START TIME screen (See page 36)  
IP SETUP screen (See page 39)  
DNS SETUP screen (See page 39)

- When these screens are open, press the ← or / (slash) keys to move the cursor left or the → or Enter keys to move it right.
- On the IP SETUP and DNS SETUP screens, use the . (decimal point) key to move the cursor right.
- Use the ↑ or + keys to increase values.
- Use the ↓ or – keys to decrease values.

## List of keyboard operations

In addition to inputting names, you can also use the keyboard for transport control, editing and various other operations.

The functions of buttons on the front of the unit are assigned to the keyboard as follows. Character input and control modes switch automatically according to the unit operation.

### ■ Full keyboard

Keyboard key	Function
Esc key	Same as <b>EXIT [PEAK CLEAR]</b> button
Shift key	Same as <b>SHIFT</b> button
F1 key	Same as <b>HOME [METER]</b> button
F2 key	Same as <b>INFO</b> button
F3 key	Same as <b>MENU</b> button
F12 key	Same as <b>● [SPLIT]</b> button
Shift + F1 key	When the meter mode setting is 32ch, press this button while pressing and holding the <b>SHIFT</b> button to switch between showing level meters for channels 1-32 and 33-64 on the Home Screen. (See “Setting the meter mode” on page 53.)
Shift + F2 key	Open <b>MARK INFO</b> screen
Shift + F3 key	Go to previous page of menu screen

Keyboard key	Function
R key	Search backward ( <b>REW</b> )
P key	Skip to the <b>P</b> revious take
Shift + P key	Skip to the previous mark
S key	<b>Stop</b>
F key	Search <b>F</b> orward
N key	Skip to the <b>N</b> ext take
Shift + N key	Skip to the following mark
Enter key	Same as pressing the <b>MULTI JOG</b> dial (add/delete mark)
Shift + Enter key	When the Home Screen is open, switch the solo selection frame color
Space bar	Same as <b>▶</b> and <b>II [CHASE]</b> buttons
↑ key	Same as <b>▶▶I</b> button during transport use; moves cursor up at other times
↓ key	Same as <b>I◀◀</b> button during transport use; moves cursor down at other times
Shift + ↑ key	When controlling the transport, skip to the following mark At other times, go to the previous menu page
Shift + ↓ key	When controlling the transport, skip to the previous mark At other times, go to the next menu page
← key	During transport operation, same as turning <b>MULTI JOG</b> dial left (move to previous mark in current take or skip to previous take when no marks); move cursor left at other times
→ key	During transport operation, same as turning <b>MULTI JOG</b> dial right (move to next mark in current take or skip to next take when no marks); move cursor right at other times

### ■ Numeric keypad (transport operations only)

Keyboard key	Function
. (decimal point) key	Same as <b>■</b> button
0 key	Same as <b>▶</b> and <b>II [CHASE]</b> buttons
1 key	Search backward
2 key	Search forward
3 key	Same as <b>● [SPLIT]</b> button
4 key	Search backward at high speed
5 key	Search forward at high speed
7 key	Skip to previous take
8 key	Skip to next take
– key	Same as turning <b>MULTI JOG</b> dial left (move to previous mark in current take, skip to previous take when no marks)
+ key	Same as turning <b>MULTI JOG</b> dial right (move to next mark in current take, skip to next take when no marks)
Enter key	Same as pressing the <b>MULTI JOG</b> dial (add/delete mark)
* (asterisk) key	When the Home Screen is open, press to switch to location input mode
/ (slash) key	When in location input mode, delete one digit of the input value

# 11 – Other Settings, Information Screens and Keyboard Operations

## Setting the power redundancy check function (DA-6400dp only)

The DA-6400dp has two power supply circuits to allow redundant power, which can prevent problems caused by power supply issues.

When shipped new from the factory, the power redundancy check function is set to ON. To use this function, connect each circuit to a different power supply.

When the power redundancy check function is ON, if the unit determines that one power supply connection has been interrupted, the **INFO** indicator will light red.

To disable the power supply redundancy check function, select the **POWER REDUNDANCY CHECK** item on the **PREFERENCES** page.

1. Select the **POWER REDUNDANCY CHECK** item on the **PREFERENCES** page to open the **POWER REDUNDANCY CHECK** screen. (See “Menu operation procedures” on page 16.)

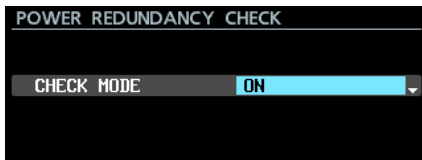

2. Turn the power redundancy check function on or off.  
Options: ON (default), OFF
3. Confirm the setting and return to the Menu Screen.

### NOTE

When making a setting, you can press the **EXIT [PEAK CLEAR]** button to cancel the changes and return to the Menu Screen.

## Exporting/importing system backup data

You can export the system backup data from the unit's built-in memory to a USB flash drive connected to the **USB2.0** port on the front of the unit. You can also import this data.

1. Select the **SYSTEM BACKUP** item on the **SYSTEM SETUP** page to open the **SYSTEM BACKUP** screen. (See “Menu operation procedures” on page 16.)



2. Select whether to export or import system backup data to or from a USB flash drive.  
**EXPORT**: export system backup data to a USB flash drive  
**IMPORT**: import system backup data from a USB flash drive
3. Press the **MULTI JOG** dial.  
A confirmation pop-up message will appear.

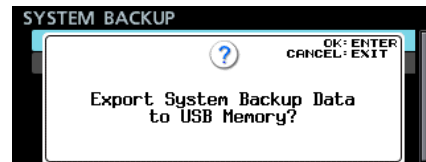

Pop-up message when set to Export

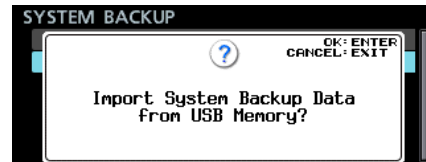

Pop-up message when set to Import

4. Press the **MULTI JOG** dial again.  
A confirmation pop-up message appears again.

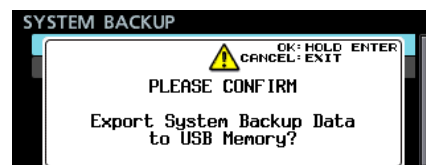

Pop-up message when set to Export

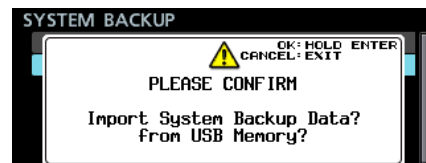

Pop-up message when set to Import

5. When the confirmation message is open, press and hold the **MULTI JOG** dial to begin exporting to or importing from the USB flash drive.

When exporting/importing ends, the **SYSTEM BACKUP** screen reopens.

### NOTE

- When **Import** was selected, one of the following pop-up messages will appear if importing did not complete properly.

If the connected USB flash drive does not contain a system backup data file

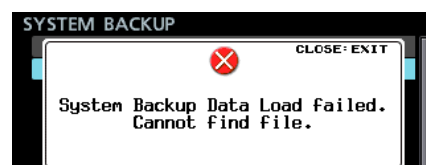

If the system backup data file on the connected USB flash drive does not contain valid data

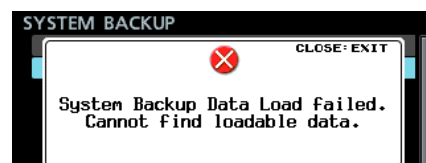

If importing completed, but some data with problems was not imported (part of the system backup data file is damaged)

# 11 – Other Settings, Information Screens and Keyboard Operations

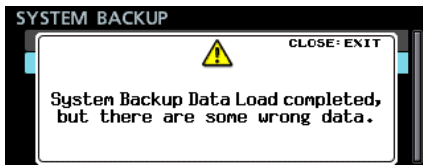

- The following setting items are saved and loaded with system backup data.

Screen name	Page name	Setting item
Home Screen		Time counter display mode
		Solo selection channel
LOCK SETUP screen		All settings
MENU screen	GENERAL page	CLOCK MASTER
		WORD/VIDEO SETUP
		REFERENCE LEVEL
		INPUT MONITOR
	REC FILE FORMAT page	All settings
	REC OPTIONS page	All settings
	PLAY SETUP page	All settings
	INPUT ROUTING 1 page	All settings
	INPUT ROUTING 2 page	All settings
	SLOT 1 page	All settings
	SLOT 2 page	All settings
	TC SETUP 1 page	All settings
	TC SETUP 2 page	All settings
	PARALLEL INPUT page	All settings
	PARALLEL OUTPUT page	All settings
	NETWORK page	IP SETUP
		DNS SETUP
		PASSWORD
SNTP page	SNTP UPDATE	
	NTP SERVER	
	UPDATE TIME	
	TIME ZONE	
	DST SETUP	
PREFERENCES page	All settings	
Others		Color display brightness setting
		Indicator brightness setting

## Restoring factory default settings

You can restore the various settings stored in the backup memory of the unit to their factory default values.

Use the following menu procedures to do so.

- On the **SYSTEM SETUP** page, select the **FACTORY PRESET** item. (See “Menu operation procedures” on page 16.)
- Press the **MULTI JOG** dial.  
A confirmation pop-up message will appear.

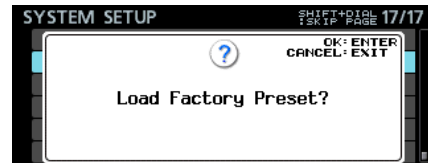

### NOTE

Press the **EXIT [PEAK CLEAR]** button to cancel.

- Press the **MULTI JOG** dial again.  
A confirmation pop-up message will appear again.



When the confirmation pop-up is open, press and hold the **MULTI JOG** dial to open a **Loading File...** pop-up and restore the unit to its factory defaults.

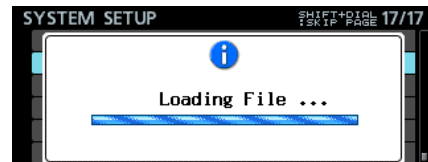

After it completes, the Menu Screen will reopen.



# 12 – Troubleshooting

If you are having trouble with the operation of this unit, please try the following before seeking repair.

If these measures do not solve the problem, please contact the store where you bought the unit or TEAC customer support (see back page).

## ■ The unit will not turn on.

- Confirm that the power plug and other connectors are inserted completely.

## ■ The media is not recognized.

- Confirm that the SSD/HDD case or USB flash drive is inserted completely.

## ■ Playback is not possible.

- If you are trying to play a WAV file, confirm that it uses a sampling frequency (44.1/48/88.2/96kHz) and a bit depth (16/24-bit) that are supported by this unit.

## ■ No sound is output.

- Check connections with the monitoring system again. Check the volume of the amplifier as well.
- If you cannot hear the input signal, turn the **INPUT MONITOR** screen setting on.
- If you cannot hear the playback signal, turn the **INPUT MONITOR** screen setting off.

## ■ Recording is not possible.

- Check connections with other equipment again.
- Check the audio source level.
- Confirm that recording is enabled for the necessary channels.
- If there is not enough room on the media, delete unnecessary data to increase the amount of open space or change the media.
- If the maximum number of recordable takes or take numbers has been reached, change the recording folder.
- If the total number of files, folders and other items inside the recording folder is great, change the recording folder.

## ■ Changed settings are forgotten.

- This unit backs up the settings every time they are changed. Backup can fail depending on when the power is turned off. Do not turn the power off immediately after changing a setting.

## ■ There is noise.

- Confirm that the connection cables do not have contact issues.

## ■ “Name Full” appears when editing a name.

- Due to file system limitations, 255 is the maximum number of characters (half-width) that can be used in folder and file names, as well as other text fields. In addition, the full path on the **BROWSE** screen is also limited to 255 characters.

## ■ Cannot create a new folder.

- Confirm that a folder with the same name does not already exist.
- New folders cannot be created if the space open on the media is low. Delete unnecessary data and then create a folder.

## ■ The SSD/HDD case is not recognized properly when it is connected to a computer.

## ■ The SSD/HDD case is recognized properly by a computer, but it stops working when writing files.

- The USB bus power supply might be insufficient. Use the included USB cable to supply power from 2 computer USB ports.

If it does not work properly even when using the included cable, the power supply capacity of the USB ports themselves might be insufficient.

In this case, load the SSD/HDD case into the unit, and follow the procedures in “Connecting an SSD/HDD to a computer” on page 49 to connect to the computer.

- If you use a commercially-available USB cable, the SSD/HDD might not function properly due to insufficient power supply caused by the resistance of the cable. Use the included USB cable.

# 13 – Specifications

---

## General

---

- **Recording media**  
SSD/HDD
- **File system**  
FAT32
- **File formats**  
BWF format (wav extension)
- **Number of channels**  
64 channels maximum (44.1/48kHz sampling frequency)  
32 channels maximum (88.2/96kHz sampling frequency)
- **Quantization bit depth**  
16/24-bit
- **Sampling frequencies**  
44.1, 48, 88.2 or 96 kHz
- **Clock references**  
INTERNAL, WORD IN, VIDEO IN, SLOT1 IN, SLOT2 IN
- **Timecode frames**  
23.976F, 24F, 25F, 29.97DF, 29.97NDF, 30DF, 30NDF

---

## Analog output

---

- **PHONES jack**  
Connector: 6.3mm (1/4") standard stereo jack  
Maximum output level: 45 mW + 45 mW or higher (THD+N 0.1% or less, when into 32  $\Omega$  load)

---

## Control input/output

---

- **USB port**  
Connector: USB 2.0 A type  
Protocol: USB 2.0 Hi Speed (480 Mbps)
- **TIME CODE IN connector**  
Connector: BNC  
Signal voltage amplitude: 0.5–5 Vp-p  
Input impedance: 10 k $\Omega$   
Format: SMPTE 12M-1999 compliant
- **TIME CODE OUT connector**  
Connector: BNC  
Signal voltage amplitude: 2 Vp-p  
Output impedance: 600  $\Omega$   
Format: SMPTE 12M-1999 compliant

- **WORD/VIDEO IN connector**  
Connector: BNC  
Signal voltage amplitude: 0.5–5 Vp-p (WORD IN)/1 Vp-p (VIDEO IN)  
Input impedance: 75  $\Omega$   $\pm$ 10% (termination resistance on)  
(See "Making word/video connector settings" on page 23 for details about turning termination resistance on/off)  
Input frequency (WORD): 44.1, 48, 88.2, 96 kHz  
Input signal (VIDEO): 24/25/29.97/30-frame (NTSC/PAL black burst, HDTV tri-Level)
- **WORD/VIDEO THRU/OUT connector**  
Connector: BNC  
Signal voltage amplitude: 5V TTL equivalent  
Output frequency (WORD): 44.1, 48, 88.2, 96 kHz  
Only THRU OUT for VIDEO signal  
(See "Making word/video connector settings" on page 23 for details about OUT/THRU switching)
- **ETHERNET connector**  
Connector: RJ45  
Compatible standards: 100BASE-TX, 1000BASE-T
- **RS-422 terminal**  
Connector: 9-pin D-sub (female, inch-standard)
- **PARALLEL connector**  
Connector: 15-pin D-sub (female, inch-standard)

---

## Other

---

- **Power**  
AC 100-240V, 50/60Hz
- **Power consumption**  
21 W (when IF-MA64/EX installed)
- **External dimensions**  
482.6  $\times$  44.7  $\times$  304.8 mm (width  $\times$  height  $\times$  depth)
- **Weight**  
DA-6400: 3.9 kg  
DA-6400dp: 4.0 kg  
(Without I/O card (sold separately) or SSD/HDD case installed)
- **Operating temperature range**  
0°C – 40°C (32°F – 104°F)

## Dimensional drawings

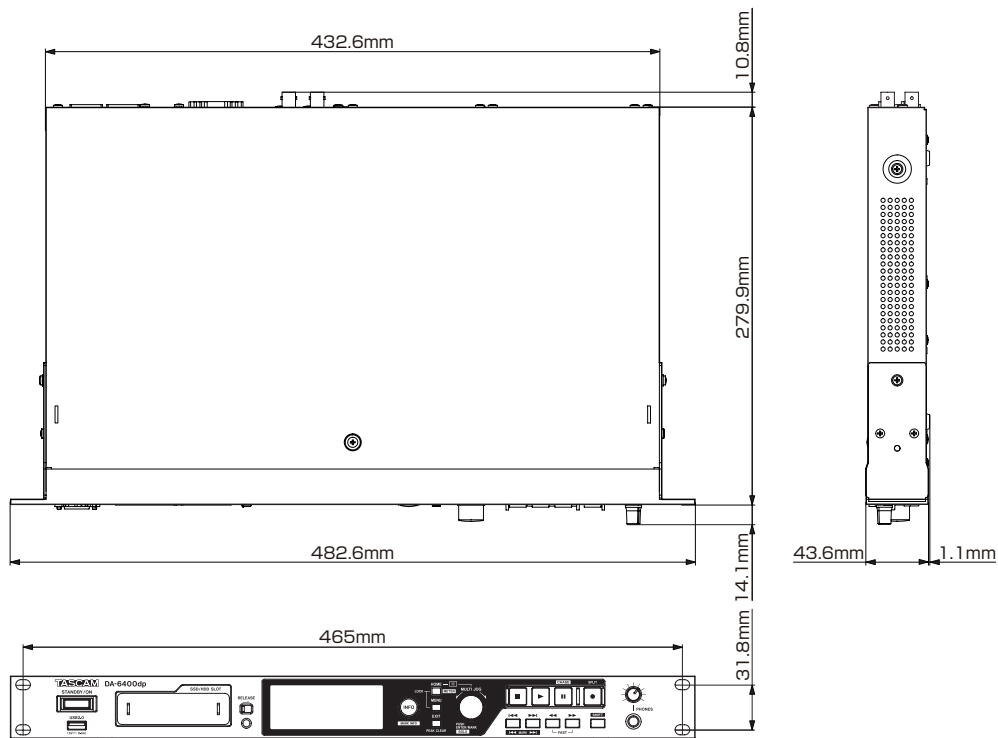

- Illustrations in this manual might differ in part from the actual product.
- Specifications and external appearance might be changed without notification to improve the product.

## Block diagrams

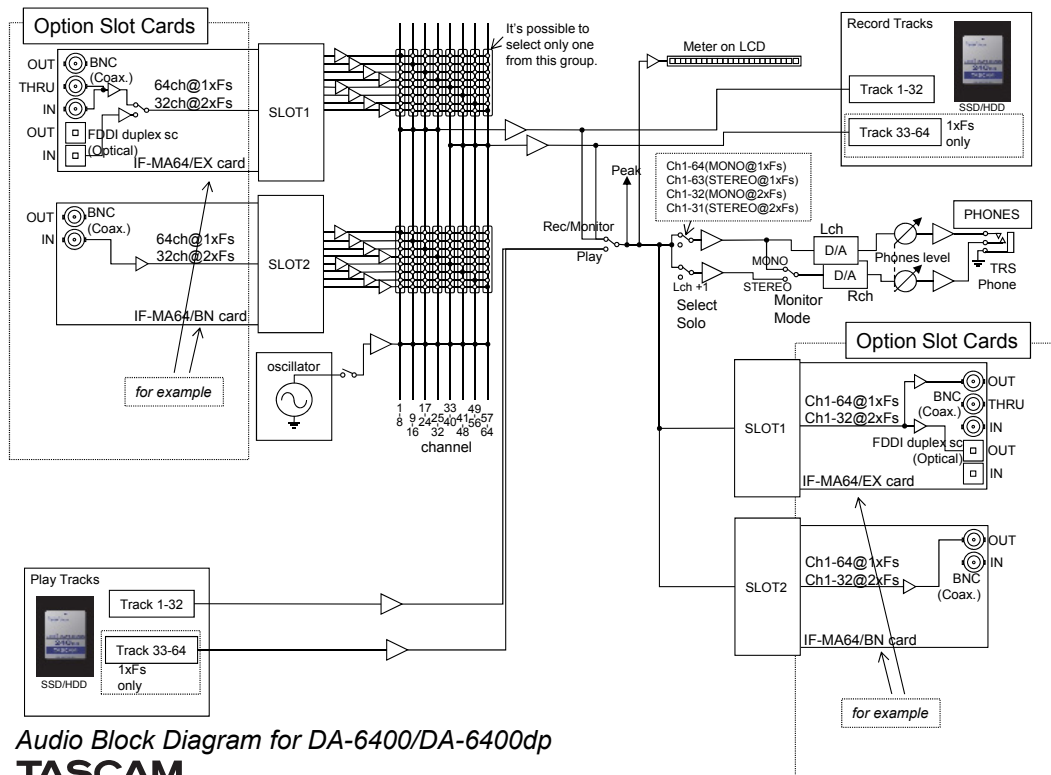

# 14 – Important notice regarding software

## Open Source License Term

As some of the Open Source and Public Domain Software is used in eT-Kernel/Compact and PrCONNECT/Pro, the following Copyright and/or License Term need to be described accordingly.

(1)eT-Kernel/Compact

Copyright (c) 1982, 1985, 1993  
The Regents of the University of California. All rights reserved.

Copyright (c) 1982, 1986, 1993  
The Regents of the University of California. All rights reserved.

Copyright (c) 1982, 1986, 1989, 1993  
The Regents of the University of California. All rights reserved.  
(c) UNIX System Laboratories, Inc.  
All or some portions of this file are derived from material licensed to the University of California by American Telephone and Telegraph Co. or Unix System Laboratories, Inc. and are reproduced herein with the permission of UNIX System Laboratories, Inc.

Copyright (c) 1982, 1986, 1991, 1993, 1994  
The Regents of the University of California. All rights reserved.  
(c) UNIX System Laboratories, Inc.  
All or some portions of this file are derived from material licensed to the University of California by American Telephone and Telegraph Co. or Unix System Laboratories, Inc. and are reproduced herein with the permission of UNIX System Laboratories, Inc.

Copyright (c) 1983, 1990, 1993  
The Regents of the University of California. All rights reserved.

Copyright (c) 1983, 1990, 1993  
The Regents of the University of California. All rights reserved.  
(c) UNIX System Laboratories, Inc.  
All or some portions of this file are derived from material licensed to the University of California by American Telephone and Telegraph Co. or Unix System Laboratories, Inc. and are reproduced herein with the permission of UNIX System Laboratories, Inc.

Copyright (c) 1983, 1993  
The Regents of the University of California. All rights reserved.

Copyright (c) 1987, 1991, 1993  
The Regents of the University of California. All rights reserved.

Copyright (c) 1987, 1993  
The Regents of the University of California. All rights reserved.

Copyright (c) 1988 Regents of the University of California.  
All rights reserved.

Copyright (c) 1988 University of Utah.  
Copyright (c) 1992, 1993  
The Regents of the University of California. All rights reserved.  
This code is derived from software contributed to Berkeley by the Systems Programming Group of the University of Utah Computer Science Department and Ralph Campbell.

Copyright (c) 1988, 1993  
The Regents of the University of California. All rights reserved.

Copyright (c) 1989 The Regents of the University of California.  
All rights reserved.

Copyright (c) 1989 The Regents of the University of California.  
All rights reserved.  
(c) UNIX System Laboratories, Inc.  
All or some portions of this file are derived from material licensed to the University of California by American Telephone and Telegraph Co. or Unix System Laboratories, Inc. and are reproduced herein with the permission of UNIX System Laboratories, Inc.

Copyright (c) 1989, 1993  
The Regents of the University of California. All rights reserved.

Copyright (c) 1989, 1993  
The Regents of the University of California. All rights reserved.  
(c) UNIX System Laboratories, Inc.  
All or some portions of this file are derived from material licensed to the University of California by American Telephone and Telegraph Co. or Unix System Laboratories, Inc. and are reproduced herein with the permission of UNIX System Laboratories, Inc.

Copyright (c) 1990, 1993  
The Regents of the University of California. All rights reserved.  
Copyright (c) 1990, 1993  
The Regents of the University of California. All rights reserved.

This code is derived from software contributed to Berkeley by Chris Torek.

Copyright (c) 1991, 1993  
The Regents of the University of California. All rights reserved.

Copyright (c) 1991, 1993  
The Regents of the University of California. All rights reserved.  
This code is derived from software contributed to Berkeley by Berkeley Software Design, Inc.

Copyright (c) 1992, 1993  
The Regents of the University of California. All rights reserved.

Copyright (c) 1992, 1993  
The Regents of the University of California. All rights reserved.  
This code is derived from software contributed to Berkeley by Ralph Campbell.

Copyright (c) 1992, 1993  
The Regents of the University of California. All rights reserved.  
(c) UNIX System Laboratories, Inc.  
All or some portions of this file are derived from material licensed to the University of California by American Telephone and Telegraph Co. or Unix System Laboratories, Inc. and are reproduced herein with the permission of UNIX System Laboratories, Inc.

Copyright (c) 1993  
The Regents of the University of California. All rights reserved.

Copyright (c) 1994  
The Regents of the University of California. All rights reserved.  
This code is derived from software contributed to Berkeley by Andrew Hume of AT&T Bell Laboratories.

Portions Copyright (c) 1993 by Digital Equipment Corporation.

Redistribution and use in source and binary forms, with or without modification, are permitted provided that the following conditions are met:

1. Redistributions of source code must retain the above copyright notice, this list of conditions and the following disclaimer.
2. Redistributions in binary form must reproduce the above copyright notice, this list of conditions and the following disclaimer in the documentation and/or other materials provided with the distribution.
3. [rescinded 22 July 1999]
4. Neither the name of the University nor the names of its contributors may be used to endorse or promote products derived from this software without specific prior written permission.

THIS SOFTWARE IS PROVIDED BY THE REGENTS AND CONTRIBUTORS "AS IS" AND ANY EXPRESS OR IMPLIED WARRANTIES, INCLUDING, BUT NOT LIMITED TO, THE IMPLIED WARRANTIES OF MERCHANTABILITY AND FITNESS FOR A PARTICULAR PURPOSE ARE DISCLAIMED.

IN NO EVENT SHALL THE REGENTS OR CONTRIBUTORS BE LIABLE FOR ANY DIRECT, INDIRECT, INCIDENTAL, SPECIAL, EXEMPLARY, OR CONSEQUENTIAL DAMAGES (INCLUDING, BUT NOT LIMITED TO, PROCUREMENT OF SUBSTITUTE GOODS OR SERVICES; LOSS OF USE, DATA, OR PROFITS; OR BUSINESS INTERRUPTION) HOWEVER CAUSED AND ON ANY THEORY OF LIABILITY, WHETHER IN CONTRACT, STRICT LIABILITY, OR TORT (INCLUDING NEGLIGENCE OR OTHERWISE) ARISING IN ANY WAY OUT OF THE USE OF THIS SOFTWARE, EVEN IF ADVISED OF THE POSSIBILITY OF SUCH DAMAGE.

-  
Copyright (c) 1982, 1986, 1990, 1993  
The Regents of the University of California. All rights reserved.

Copyright (c) 1983, 1993  
The Regents of the University of California. All rights reserved.

Copyright (c) 1990, 1993  
The Regents of the University of California. All rights reserved.

Redistribution and use in source and binary forms, with or without modification, are permitted provided that the following conditions are met:

1. Redistributions of source code must retain the above copyright notice, this list of conditions and the following disclaimer.
2. Redistributions in binary form must reproduce the above copyright notice, this list of conditions and the following disclaimer in the documentation and/or other materials provided with the distribution.
3. Neither the name of the University nor the names of its contributors may be used to endorse or promote products derived from this software without specific prior written permission.

THIS SOFTWARE IS PROVIDED BY THE REGENTS AND CONTRIBUTORS "AS IS" AND ANY EXPRESS OR IMPLIED WARRANTIES, INCLUDING, BUT NOT LIMITED TO, THE IMPLIED WARRANTIES OF MERCHANTABILITY AND FITNESS FOR A PARTICULAR PURPOSE ARE DISCLAIMED.

IN NO EVENT SHALL THE REGENTS OR CONTRIBUTORS BE LIABLE FOR ANY DIRECT, INDIRECT, INCIDENTAL, SPECIAL, EXEMPLARY, OR CONSEQUENTIAL DAMAGES (INCLUDING, BUT NOT LIMITED TO, PROCUREMENT OF SUBSTITUTE GOODS OR SERVICES; LOSS OF USE, DATA, OR PROFITS; OR BUSINESS INTERRUPTION) HOWEVER CAUSED AND ON ANY THEORY OF LIABILITY, WHETHER IN CONTRACT, STRICT LIABILITY, OR TORT (INCLUDING NEGLIGENCE OR OTHERWISE) ARISING IN ANY WAY OUT OF THE USE OF THIS SOFTWARE, EVEN IF ADVISED OF THE POSSIBILITY OF SUCH DAMAGE.

Copyright (c) 1991, 1993, 1994  
The Regents of the University of California. All rights reserved.

-  
Copyright (c) 1996 The NetBSD Foundation, Inc.  
All rights reserved.  
This code is derived from software contributed to The NetBSD Foundation by J.T. Conklin.

Copyright (c) 1997 The NetBSD Foundation, Inc.  
All rights reserved.  
This code is derived from software contributed to The NetBSD Foundation by Klaus Klein.

Copyright (c) 1997, 1998 The NetBSD Foundation, Inc.  
All rights reserved.

Copyright (c) 1997, 98 The NetBSD Foundation, Inc.  
All rights reserved.  
This code is derived from software contributed to The NetBSD Foundation by J.T. Conklin.

Copyright (c) 1997, 1998 The NetBSD Foundation, Inc.  
All rights reserved.  
This code was contributed to The NetBSD Foundation by Klaus Klein.

Copyright (c) 1998 The NetBSD Foundation, Inc.  
All rights reserved.  
This code is derived from software contributed to The NetBSD Foundation by Klaus Klein.

Copyright (c) 1998, 1999 The NetBSD Foundation, Inc.  
All rights reserved.  
This code is derived from software contributed to The NetBSD Foundation by Klaus Klein.

Copyright (c) 1998, 2000 The NetBSD Foundation, Inc.  
All rights reserved.  
This code is derived from software contributed to The NetBSD Foundation by Klaus J. Klein.

Copyright (c) 2000 The NetBSD Foundation, Inc.  
All rights reserved.  
This code is derived from software contributed to The NetBSD Foundation by Dieter Baron and Thomas Klausner.

Copyright (c) 2000, 2001 The NetBSD Foundation, Inc.  
All rights reserved.  
This code is derived from software contributed to The NetBSD Foundation by Jun-ichiro itojun Hagino and by Klaus Klein.

Copyright (c) 2001 The NetBSD Foundation, Inc.  
All rights reserved.  
This code is derived from software contributed to The NetBSD Foundation by Klaus Klein.

Redistribution and use in source and binary forms, with or without modification, are permitted provided that the following conditions are met:

1. Redistributions of source code must retain the above copyright notice, this list of conditions and the following disclaimer.
2. Redistributions in binary form must reproduce the above copyright notice, this list of conditions and the following disclaimer in the documentation and/or other materials provided with the distribution.
3. [rescinded 20 Jun 2008]
4. [rescinded 20 Jun 2008]

THIS SOFTWARE IS PROVIDED BY THE NETBSD FOUNDATION, INC. AND

# 14 – Important notice regarding software

CONTRIBUTORS "AS IS" AND ANY EXPRESS OR IMPLIED WARRANTIES, INCLUDING, BUT NOT LIMITED TO, THE IMPLIED WARRANTIES OF MERCHANTABILITY AND FITNESS FOR A PARTICULAR PURPOSE ARE DISCLAIMED.

IN NO EVENT SHALL THE FOUNDATION OR CONTRIBUTORS BE LIABLE FOR ANY DIRECT, INDIRECT, INCIDENTAL, SPECIAL, EXEMPLARY, OR CONSEQUENTIAL DAMAGES (INCLUDING, BUT NOT LIMITED TO, PROCUREMENT OF SUBSTITUTE GOODS OR SERVICES; LOSS OF USE, DATA, OR PROFITS; OR BUSINESS INTERRUPTION) HOWEVER CAUSED AND ON ANY THEORY OF LIABILITY, WHETHER IN CONTRACT, STRICT LIABILITY, OR TORT (INCLUDING NEGLIGENCE OR OTHERWISE) ARISING IN ANY WAY OUT OF THE USE OF THIS SOFTWARE, EVEN IF ADVISED OF THE POSSIBILITY OF SUCH DAMAGE.

-  
This product includes software developed by Christos Zoulas.

Copyright (c) 1997 Christos Zoulas. All rights reserved.

Redistribution and use in source and binary forms, with or without modification, are permitted provided that the following conditions are met:

1. Redistributions of source code must retain the above copyright notice, this list of conditions and the following disclaimer.
2. Redistributions in binary form must reproduce the above copyright notice, this list of conditions and the following disclaimer in the documentation and/or other materials provided with the distribution.
3. All advertising materials mentioning features or use of this software must display the following acknowledgement:

This product includes software developed by Christos Zoulas.

4. The name of the author may not be used to endorse or promote products derived from this software without specific prior written permission.

THIS SOFTWARE IS PROVIDED BY THE AUTHOR "AS IS" AND ANY EXPRESS OR IMPLIED WARRANTIES, INCLUDING, BUT NOT LIMITED TO, THE IMPLIED WARRANTIES OF MERCHANTABILITY AND FITNESS FOR A PARTICULAR PURPOSE ARE DISCLAIMED.

IN NO EVENT SHALL THE AUTHOR BE LIABLE FOR ANY DIRECT, INDIRECT, INCIDENTAL, SPECIAL, EXEMPLARY, OR CONSEQUENTIAL DAMAGES (INCLUDING, BUT NOT LIMITED TO, PROCUREMENT OF SUBSTITUTE GOODS OR SERVICES; LOSS OF USE, DATA, OR PROFITS; OR BUSINESS INTERRUPTION) HOWEVER CAUSED AND ON ANY THEORY OF LIABILITY, WHETHER IN CONTRACT, STRICT LIABILITY, OR TORT (INCLUDING NEGLIGENCE OR OTHERWISE) ARISING IN ANY WAY OUT OF THE USE OF THIS SOFTWARE, EVEN IF ADVISED OF THE POSSIBILITY OF SUCH DAMAGE.

-  
This product includes software developed by Winning Strategies, Inc.

Copyright (c) 1994 Winning Strategies, Inc.  
All rights reserved.

Redistribution and use in source and binary forms, with or without modification, are permitted provided that the following conditions are met:

1. Redistributions of source code must retain the above copyright notice, this list of conditions and the following disclaimer.
2. Redistributions in binary form must reproduce the above copyright notice, this list of conditions and the following disclaimer in the documentation and/or other materials provided with the distribution.
3. All advertising materials mentioning features or use of this software must display the following acknowledgement:  
This product includes software developed by Winning Strategies, Inc.
4. The name of the author may not be used to endorse or promote products derived from this software without specific prior written permission.

THIS SOFTWARE IS PROVIDED BY THE AUTHOR "AS IS" AND ANY EXPRESS OR IMPLIED WARRANTIES, INCLUDING, BUT NOT LIMITED TO, THE IMPLIED WARRANTIES OF MERCHANTABILITY AND FITNESS FOR A PARTICULAR PURPOSE ARE DISCLAIMED.

IN NO EVENT SHALL THE AUTHOR BE LIABLE FOR ANY DIRECT, INDIRECT, INCIDENTAL, SPECIAL, EXEMPLARY, OR CONSEQUENTIAL DAMAGES (INCLUDING, BUT NOT LIMITED TO, PROCUREMENT OF SUBSTITUTE GOODS OR SERVICES; LOSS OF USE, DATA, OR PROFITS; OR BUSINESS INTERRUPTION) HOWEVER CAUSED AND ON ANY THEORY OF LIABILITY, WHETHER IN CONTRACT, STRICT LIABILITY, OR TORT (INCLUDING NEGLIGENCE OR OTHERWISE) ARISING IN ANY WAY OUT OF THE USE OF THIS SOFTWARE, EVEN IF ADVISED OF THE POSSIBILITY OF SUCH DAMAGE.

-  
Copyright (C) 1995, 1996, 1997, and 1998 WIDE Project.  
All rights reserved.

Redistribution and use in source and binary forms, with or without modification, are permitted provided that the following conditions are met:

1. Redistributions of source code must retain the above copyright notice, this list of conditions and the following disclaimer.

2. Redistributions in binary form must reproduce the above copyright notice, this list of conditions and the following disclaimer in the documentation and/or other materials provided with the distribution.
3. Neither the name of the project nor the names of its contributors may be used to endorse or promote products derived from this software without specific prior written permission.

THIS SOFTWARE IS PROVIDED BY THE PROJECT AND CONTRIBUTORS "AS IS" AND ANY EXPRESS OR IMPLIED WARRANTIES, INCLUDING, BUT NOT LIMITED TO, THE IMPLIED WARRANTIES OF MERCHANTABILITY AND FITNESS FOR A PARTICULAR PURPOSE ARE DISCLAIMED.

IN NO EVENT SHALL THE PROJECT OR CONTRIBUTORS BE LIABLE FOR ANY DIRECT, INDIRECT, INCIDENTAL, SPECIAL, EXEMPLARY, OR CONSEQUENTIAL DAMAGES (INCLUDING, BUT NOT LIMITED TO, PROCUREMENT OF SUBSTITUTE GOODS OR SERVICES; LOSS OF USE, DATA, OR PROFITS; OR BUSINESS INTERRUPTION) HOWEVER CAUSED AND ON ANY THEORY OF LIABILITY, WHETHER IN CONTRACT, STRICT LIABILITY, OR TORT (INCLUDING NEGLIGENCE OR OTHERWISE) ARISING IN ANY WAY OUT OF THE USE OF THIS SOFTWARE, EVEN IF ADVISED OF THE POSSIBILITY OF SUCH DAMAGE.

-  
Copyright (c) 1999 Citrus Project,  
All rights reserved.

Redistribution and use in source and binary forms, with or without modification, are permitted provided that the following conditions are met:

1. Redistributions of source code must retain the above copyright notice, this list of conditions and the following disclaimer.
2. Redistributions in binary form must reproduce the above copyright notice, this list of conditions and the following disclaimer in the documentation and/or other materials provided with the distribution.

THIS SOFTWARE IS PROVIDED BY THE AUTHOR AND CONTRIBUTORS "AS IS" AND ANY EXPRESS OR IMPLIED WARRANTIES, INCLUDING, BUT NOT LIMITED TO, THE IMPLIED WARRANTIES OF MERCHANTABILITY AND FITNESS FOR A PARTICULAR PURPOSE ARE DISCLAIMED.

IN NO EVENT SHALL THE AUTHOR OR CONTRIBUTORS BE LIABLE FOR ANY DIRECT, INDIRECT, INCIDENTAL, SPECIAL, EXEMPLARY, OR CONSEQUENTIAL DAMAGES (INCLUDING, BUT NOT LIMITED TO, PROCUREMENT OF SUBSTITUTE GOODS OR SERVICES; LOSS OF USE, DATA, OR PROFITS; OR BUSINESS INTERRUPTION) HOWEVER CAUSED AND ON ANY THEORY OF LIABILITY, WHETHER IN CONTRACT, STRICT LIABILITY, OR TORT (INCLUDING NEGLIGENCE OR OTHERWISE) ARISING IN ANY WAY OUT OF THE USE OF THIS SOFTWARE, EVEN IF ADVISED OF THE POSSIBILITY OF SUCH DAMAGE.

Copyright (c) 1999, 2000 The NetBSD Foundation, Inc.  
All rights reserved.

This code is derived from software contributed to The NetBSD Foundation by Julian Coleman.

Redistribution and use in source and binary forms, with or without modification, are permitted provided that the following conditions are met:

1. Redistributions of source code must retain the above copyright notice, this list of conditions and the following disclaimer.
2. Redistributions in binary form must reproduce the above copyright notice, this list of conditions and the following disclaimer in the documentation and/or other materials provided with the distribution.
3. All advertising materials mentioning features or use of this software must display the following acknowledgement:  
This product includes software developed by the NetBSD

-  
Copyright (c) 1995, 1996 Carnegie-Mellon University.  
All rights reserved.

Author: Chris G. Demetrious

Permission to use, copy, modify and distribute this software and its documentation is hereby granted, provided that both the copyright notice and this permission notice appear in all copies of the software, derivative works or modified versions, and any portions thereof, and that both notices appear in supporting documentation.

CARNEGIE MELLON ALLOWS FREE USE OF THIS SOFTWARE IN ITS "AS IS" CONDITION. CARNEGIE MELLON DISCLAIMS ANY LIABILITY OF ANY KIND FOR ANY DAMAGES WHATSOEVER RESULTING FROM THE USE OF THIS SOFTWARE.

Carnegie Mellon requests users of this software to return to

Software Distribution Coordinator or Software.Distribution@CS.CMU.EDU  
School of Computer Science  
Carnegie Mellon University  
Pittsburgh PA 15213-3890

any improvements or extensions that they make and grant Carnegie the

rights to redistribute these changes.

(2) PrCONNECT/PRO

Copyright (c) 1980, 1983, 1988, 1993  
The Regents of the University of California. All rights reserved.

Copyright (c) 1982, 1986 Regents of the University of California.  
All rights reserved.

Copyright (c) 1983, 1987, 1989  
The Regents of the University of California. All rights reserved.

Copyright (c) 1983, 1989, 1993  
The Regents of the University of California. All rights reserved.

Copyright (c) 1985, 1988, 1993  
The Regents of the University of California. All rights reserved.

Copyright (c) 1985, 1989, 1993  
The Regents of the University of California. All rights reserved.

Copyright (c) 1983, 1993  
The Regents of the University of California. All rights reserved.

Copyright (c) 1985, 1993  
The Regents of the University of California. All rights reserved.

Copyright (c) 1988 Stephen Deering.

Copyright (c) 1989, 1993, 1995  
The Regents of the University of California. All rights reserved.

Redistribution and use in source and binary forms, with or without modification, are permitted provided that the following conditions are met:

1. Redistributions of source code must retain the above copyright notice, this list of conditions and the following disclaimer.
2. Redistributions in binary form must reproduce the above copyright notice, this list of conditions and the following disclaimer in the documentation and/or other materials provided with the distribution.
3. [rescinded 22 July 1999]
4. Neither the name of the University nor the names of its contributors may be used to endorse or promote products derived from this software without specific prior written permission.

THIS SOFTWARE IS PROVIDED BY THE REGENTS AND CONTRIBUTORS "AS IS" AND ANY EXPRESS OR IMPLIED WARRANTIES, INCLUDING, BUT NOT LIMITED TO, THE IMPLIED WARRANTIES OF MERCHANTABILITY AND FITNESS FOR A PARTICULAR PURPOSE ARE DISCLAIMED.

IN NO EVENT SHALL THE REGENTS OR CONTRIBUTORS BE LIABLE FOR ANY DIRECT, INDIRECT, INCIDENTAL, SPECIAL, EXEMPLARY, OR CONSEQUENTIAL DAMAGES (INCLUDING, BUT NOT LIMITED TO, PROCUREMENT OF SUBSTITUTE GOODS OR SERVICES; LOSS OF USE, DATA, OR PROFITS; OR BUSINESS INTERRUPTION) HOWEVER CAUSED AND ON ANY THEORY OF LIABILITY, WHETHER IN CONTRACT, STRICT LIABILITY, OR TORT (INCLUDING NEGLIGENCE OR OTHERWISE) ARISING IN ANY WAY OUT OF THE USE OF THIS SOFTWARE, EVEN IF ADVISED OF THE POSSIBILITY OF SUCH DAMAGE.

Portions Copyright (c) 1993 by Digital Equipment Corporation.

Permission to use, copy, modify, and distribute this software for any purpose with or without fee is hereby granted, provided that the above copyright notice and this permission notice appear in all copies, and that the name of Digital Equipment Corporation not be used in advertising or publicity pertaining to distribution of the document or software without specific, written prior permission.

THE SOFTWARE IS PROVIDED "AS IS" AND DIGITAL EQUIPMENT CORP. DISCLAIMS ALL WARRANTIES WITH REGARD TO THIS SOFTWARE, INCLUDING ALL IMPLIED WARRANTIES OF MERCHANTABILITY AND FITNESS.

IN NO EVENT SHALL DIGITAL EQUIPMENT CORPORATION BE LIABLE FOR ANY SPECIAL, DIRECT, INDIRECT, OR CONSEQUENTIAL DAMAGES OR ANY DAMAGES WHATSOEVER RESULTING FROM LOSS OF USE, DATA OR PROFITS, WHETHER IN AN ACTION OF CONTRACT, NEGLIGENCE OR OTHER TORTIOUS ACTION, ARISING OUT OF OR IN CONNECTION WITH THE USE OR PERFORMANCE OF THIS SOFTWARE.

Copyright (c) 2004 by Internet Systems Consortium, Inc. ("ISC")  
Portions Copyright (c) 1996-1999 by Internet Software Consortium.

Permission to use, copy, modify, and distribute this software for any purpose with or without fee is hereby granted, provided that the above copyright notice and this permission notice appear in all copies.

THE SOFTWARE IS PROVIDED "AS IS" AND ISC DISCLAIMS ALL WARRANTIES WITH REGARD TO THIS SOFTWARE INCLUDING ALL IMPLIED WARRANTIES OF MERCHANTABILITY AND FITNESS.



# 14 – Important notice regarding software

IN NO EVENT SHALL ISC BE LIABLE FOR ANY SPECIAL, DIRECT, INDIRECT, OR CONSEQUENTIAL DAMAGES OR ANY DAMAGES WHATSOEVER RESULTING FROM LOSS OF USE, DATA OR PROFITS, WHETHER IN AN ACTION OF CONTRACT, NEGLIGENCE OR OTHER TORTIOUS ACTION, ARISING OUT OF OR IN CONNECTION WITH THE USE OR PERFORMANCE OF THIS SOFTWARE.

Copyright 1996 - 2000 By InterNiche Technologies Inc. All rights reserved  
Copyright 1997 - 2000 By InterNiche Technologies Inc. All rights reserved  
Copyright 1997 - 2002 By InterNiche Technologies Inc. All rights reserved  
Copyright 1997 - 2003 By InterNiche Technologies Inc. All rights reserved  
Copyright 1997-2007 By InterNiche Technologies Inc. All rights reserved  
Copyright 2004 By InterNiche Technologies Inc. All rights reserved

Redistribution and use in source and binary forms, with or without modification, are permitted provided that the following conditions are met:

1. Redistributions of source code must retain the above copyright notice, this list of conditions and the following disclaimer.
2. Redistributions in binary form must reproduce the above copyright notice, this list of conditions and the following disclaimer in the documentation and/or other materials provided with the distribution.
3. [rescinded 22 July 1999]
4. Neither the name of the University nor the names of its contributors may be used to endorse or promote products derived from this software without specific prior written permission.

THIS SOFTWARE IS PROVIDED BY THE REGENTS AND CONTRIBUTORS "AS IS" AND ANY EXPRESS OR IMPLIED WARRANTIES, INCLUDING, BUT NOT LIMITED TO, THE IMPLIED WARRANTIES OF MERCHANTABILITY AND FITNESS FOR A PARTICULAR PURPOSE ARE DISCLAIMED.

IN NO EVENT SHALL THE REGENTS OR CONTRIBUTORS BE LIABLE FOR ANY DIRECT, INDIRECT, INCIDENTAL, SPECIAL, EXEMPLARY, OR CONSEQUENTIAL DAMAGES (INCLUDING, BUT NOT LIMITED TO, PROCUREMENT OF SUBSTITUTE GOODS OR SERVICES; LOSS OF USE, DATA, OR PROFITS; OR BUSINESS INTERRUPTION) HOWEVER CAUSED AND ON ANY THEORY OF LIABILITY, WHETHER IN CONTRACT, STRICT LIABILITY, OR TORT (INCLUDING NEGLIGENCE OR OTHERWISE) ARISING IN ANY WAY OUT OF THE USE OF THIS SOFTWARE, EVEN IF ADVISED OF THE POSSIBILITY OF SUCH DAMAGE.

Copyright (c) 2004 by Internet Systems Consortium, Inc. ("ISC")  
Portions Copyright (c) 1996-1999 by Internet Software Consortium.  
Copyright (c) 1997-1999 by Internet Software Consortium.  
Copyright (c) 1995-1999 by Internet Software Consortium.  
Copyright (c) 1995, 1999 by Internet Software Consortium.  
Copyright (c) 1996, 1999 by Internet Software Consortium.  
Copyright (c) 1997, 1999 by Internet Software Consortium.  
Copyright (c) 1999 by Internet Software Consortium.

Permission to use, copy, modify, and distribute this software for any purpose with or without fee is hereby granted, provided that the above copyright notice and this permission notice appear in all copies.

THE SOFTWARE IS PROVIDED "AS IS" AND ISC DISCLAIMS ALL WARRANTIES WITH REGARD TO THIS SOFTWARE INCLUDING ALL IMPLIED WARRANTIES OF MERCHANTABILITY AND FITNESS.

IN NO EVENT SHALL ISC BE LIABLE FOR ANY SPECIAL, DIRECT, INDIRECT, OR CONSEQUENTIAL DAMAGES OR ANY DAMAGES WHATSOEVER RESULTING FROM LOSS OF USE, DATA OR PROFITS, WHETHER IN AN ACTION OF CONTRACT, NEGLIGENCE OR OTHER TORTIOUS ACTION, ARISING OUT OF OR IN CONNECTION WITH THE USE OR PERFORMANCE OF THIS SOFTWARE.

This product includes software developed by WIDE Project and its contributors.

Copyright (C) 1995, 1996, 1997, and 1998 WIDE Project.  
All rights reserved.

Redistribution and use in source and binary forms, with or without modification, are permitted provided that the following conditions are met:

1. Redistributions of source code must retain the above copyright notice, this list of conditions and the following disclaimer.
2. Redistributions in binary form must reproduce the above copyright

notice, this list of conditions and the following disclaimer in the documentation and/or other materials provided with the distribution.

3. Neither the name of the project nor the names of its contributors may be used to endorse or promote products derived from this software without specific prior written permission.

THIS SOFTWARE IS PROVIDED BY THE PROJECT AND CONTRIBUTORS "AS IS" AND ANY EXPRESS OR IMPLIED WARRANTIES, INCLUDING, BUT NOT LIMITED TO, THE IMPLIED WARRANTIES OF MERCHANTABILITY AND FITNESS FOR A PARTICULAR PURPOSE ARE DISCLAIMED.

IN NO EVENT SHALL THE PROJECT OR CONTRIBUTORS BE LIABLE FOR ANY DIRECT, INDIRECT, INCIDENTAL, SPECIAL, EXEMPLARY, OR CONSEQUENTIAL DAMAGES (INCLUDING, BUT NOT LIMITED TO, PROCUREMENT OF SUBSTITUTE GOODS OR SERVICES; LOSS OF USE, DATA, OR PROFITS; OR BUSINESS INTERRUPTION) HOWEVER CAUSED AND ON ANY THEORY OF LIABILITY, WHETHER IN CONTRACT, STRICT LIABILITY, OR TORT (INCLUDING NEGLIGENCE OR OTHERWISE) ARISING IN ANY WAY OUT OF THE USE OF THIS SOFTWARE, EVEN IF ADVISED OF THE POSSIBILITY OF SUCH DAMAGE.

Copyright 1997-2006 By InterNiche Technologies Inc. All rights reserved

Portions Copyright 1986 by Carnegie Mellon

Portions Copyright 1984 by the Massachusetts Institute of Technology  
Copyright (c) 1982, 1986, 1988 Regents of the University of California.  
All rights reserved.

Redistribution and use in source and binary forms are permitted provided that the above copyright notice and this paragraph are duplicated in all such forms and that any documentation and other materials related to such distribution and use acknowledge that the software was developed by the University of California, Berkeley.

The name of the University may not be used to endorse or promote products derived from this software without specific prior written permission.

THIS SOFTWARE IS PROVIDED "AS IS" AND WITHOUT ANY EXPRESS OR IMPLIED WARRANTIES, INCLUDING, WITHOUT LIMITATION, THE IMPLIED WARRANTIES OF MERCHANTABILITY AND FITNESS FOR A PARTICULAR PURPOSE.

Rights, responsibilities and use of this software are controlled by the agreement found in the "LICENSE.H" file distributed with this source code. "LICENSE.H" may not be removed from this distribution, modified, enhanced nor references to it omitted.

Copyright 1983 by the Massachusetts Institute of Technology  
Copyright 1984 by the Massachusetts Institute of Technology

Copyright 1984, 1985 by the Massachusetts Institute of Technology

Copyright 1986 by Carnegie Mellon

All Rights Reserved

Permission to use, copy, modify, and distribute this software and its documentation for any purpose and without fee is hereby granted, provided that the above copyright notice appear in all copies and that both that copyright notice and this permission notice appear in supporting documentation, and that the name of CMU not be used in advertising or publicity pertaining to distribution of the software without specific, written prior permission.

Copyright 1999-2000 By InterNiche Technologies Inc. All rights reserved  
Portions Copyright 1984 by the Massachusetts Institute of Technology

Permission is hereby granted, free of charge, to any person obtaining a copy of this software and associated documentation files (the "Software"), to deal in the Software without restriction, including without limitation the rights to use, copy, modify, merge, publish, distribute, sublicense, and/or sell copies of the Software, and to permit persons to whom the Software is furnished to do so, subject to the following conditions:

The above copyright notice and this permission notice shall be included in

all copies or substantial portions of the Software.

THE SOFTWARE IS PROVIDED "AS IS", WITHOUT WARRANTY OF ANY KIND, EXPRESS OR IMPLIED, INCLUDING BUT NOT LIMITED TO THE WARRANTIES OF MERCHANTABILITY, FITNESS FOR A PARTICULAR PURPOSE AND NONINFRINGEMENT.

IN NO EVENT SHALL THE AUTHORS OR COPYRIGHT HOLDERS BE LIABLE FOR ANY CLAIM, DAMAGES OR OTHER LIABILITY, WHETHER IN AN ACTION OF CONTRACT, TORT OR OTHERWISE, ARISING FROM, OUT OF OR IN CONNECTION WITH THE SOFTWARE OR THE USE OR OTHER DEALINGS IN THE SOFTWARE.

Copyright 2000 By InterNiche Technologies Inc. All rights reserved  
Copyright 1998-2000 By InterNiche Technologies Inc. All rights reserved  
Copyright 1997-2002 By InterNiche Technologies Inc. All rights reserved  
Copyright 1997-2001 By InterNiche Technologies Inc. All rights reserved  
Copyright 1997-2000 By InterNiche Technologies Inc. All rights reserved  
Copyright 2000-2007 By InterNiche Technologies Inc. All rights reserved  
Copyright 1996-2000 By InterNiche Technologies Inc. All rights reserved  
Copyright 1986 by Carnegie Mellon  
Copyright 1984 by the Massachusetts Institute of Technology

Portions Copyright 1990 by NetPort Software.  
Portions Copyright 1990, 1993 by NetPort Software.  
Portions Copyright 1990-1993 by NetPort Software.  
Portions Copyright 1993 by NetPort Software  
Portions Copyright 1990-1996 by NetPort Software.  
Portions Copyright 1990-1997 by NetPort Software.  
Portions Copyright 1990-1994 by NetPort Software  
Portions Copyright 1986 by Carnegie Mellon  
Portions Copyright 1983 by the Massachusetts Institute of Technology  
Portions Copyright 1984 by the Massachusetts Institute of Technology  
Portions Copyright 1984, 1985 by the Massachusetts Institute of Technology

Copyright (c) 1994-2000 Carnegie Mellon University. All rights reserved.

Redistribution and use in source and binary forms, with or without modification, are permitted provided that the following conditions are met:

1. Redistributions of source code must retain the above copyright notice, this list of conditions and the following disclaimer.
2. Redistributions in binary form must reproduce the above copyright notice, this list of conditions and the following disclaimer in the documentation and/or other materials provided with the distribution.

3. The name "Carnegie Mellon University" must not be used to endorse or promote products derived from this software without prior written permission. For permission or any legal details, please contact  
Office of Technology Transfer  
Carnegie Mellon University  
5000 Forbes Avenue  
Pittsburgh, PA 15213-3890  
(412) 268-4387, fax: (412) 268-7395  
tech-transfer@andrew.cmu.edu

4. Redistributions of any form whatsoever must retain the following acknowledgment:

"This product includes software developed by Computing Services at Carnegie Mellon University (<http://www.cmu.edu/computing/>)."

CARNEGIE MELLON UNIVERSITY DISCLAIMS ALL WARRANTIES WITH REGARD TO THIS SOFTWARE, INCLUDING ALL IMPLIED WARRANTIES OF MERCHANTABILITY AND FITNESS, IN NO EVENT SHALL CARNEGIE MELLON UNIVERSITY BE LIABLE FOR ANY SPECIAL, INDIRECT OR CONSEQUENTIAL DAMAGES OR ANY DAMAGES WHATSOEVER RESULTING FROM LOSS OF USE, DATA OR PROFITS, WHETHER IN AN ACTION OF CONTRACT, NEGLIGENCE OR OTHER TORTIOUS ACTION, ARISING OUT OF OR IN CONNECTION WITH THE USE OR PERFORMANCE OF THIS SOFTWARE.





**TASCAM**