

Spider MT503 SMART

USER MANUAL



INDEX

Overview	Page 03
Connecting the Spider	Page 04
Using the Spider	Page 05
• Directional Array	Page 05
• Volume Control	Page 06
Display	Page 06
External Mic/Speaker	Page 07
Daisy Chaining	Page 09
Specifications	Page 11
Warranty	Page 12

SPIDER 503 SMART OVERVIEW

The Spider is a high-quality conference speakerphone that will turn any room into a professionally sounding conference room. It has an exceptionally large pickup and broadcasting range, yet is small in size and discreet in design.

The Spider utilizes multiple microphones, a uniquely designed speaker, and a powerful DSP to achieve commanding performance.

This guide will help you learn how to use your conference phone and will reveal all the features that come with it.

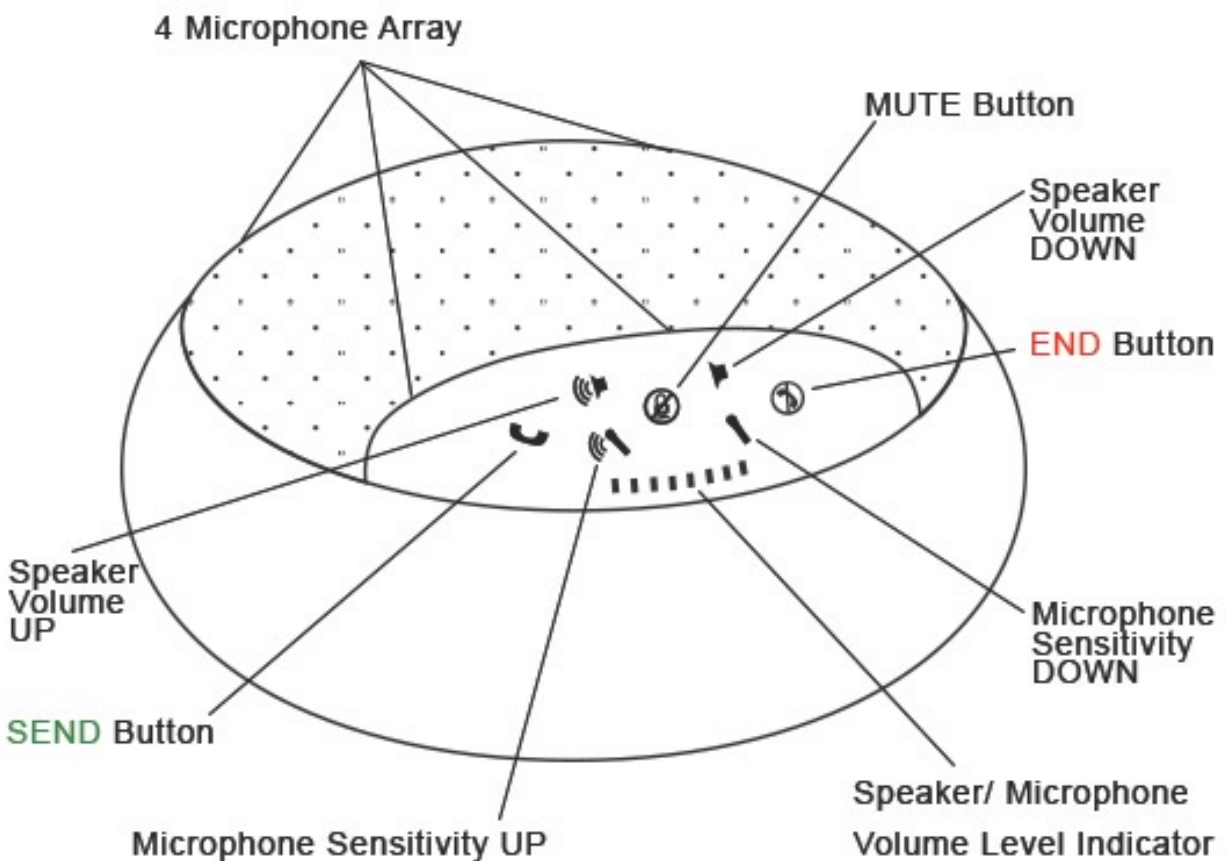

CONNECTING YOUR SPIDER

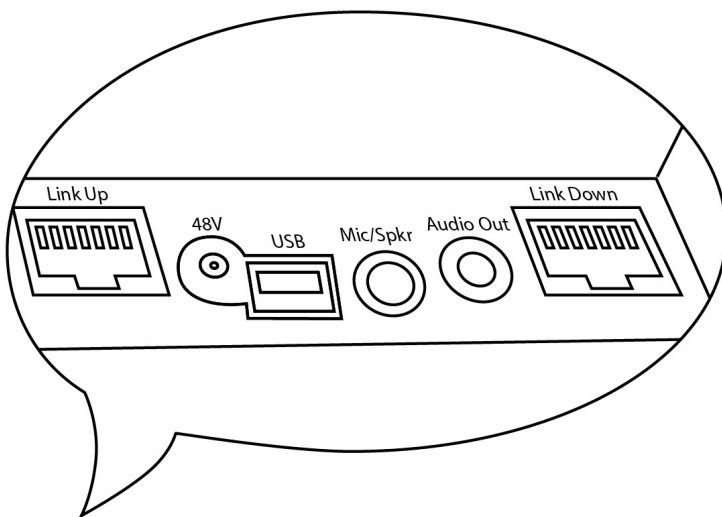
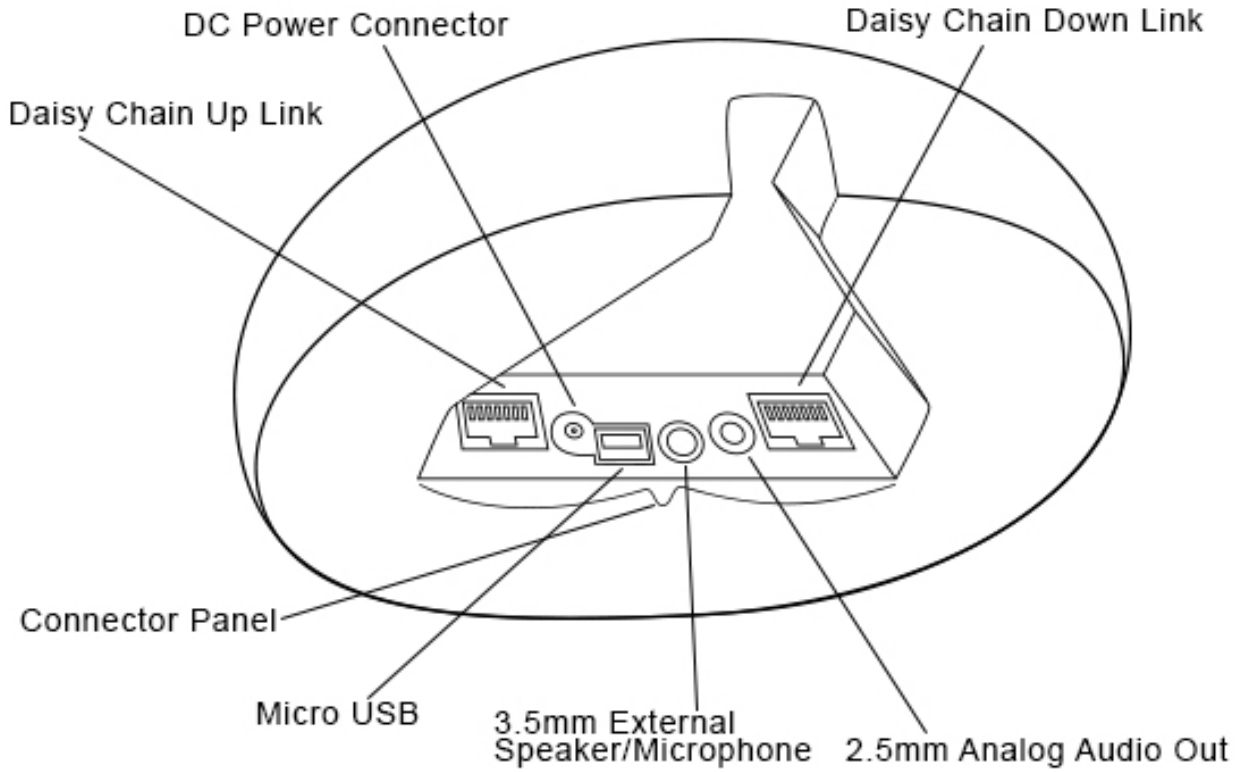

Connector Panel Detail

CONNECTING TO A COMPUTER

This connection is for any session using your computer, such as Voice over IP applications (Skype, Vidyo, etc.).

- ▶ Using the USB cable provided, plug the micro USB side of the cable into the Spider (USB connector located on the connector panel below the unit).
- ▶ Plug the USB end of the cable into any USB port on your computer.

No additional drivers or steps are needed. However, we do recommend downloading and using our “Phoenix Audio Setup Utility” for optimal audio control and performance. This utility can be found on our website: www.phnxaudio.com/downloads/audiosetup/

CONNECTING TO A SMART DEVICE

This connection is for any session using a smart phone, tablet, or any device that requires an analog audio signal (Smart Phones, Tablets, Video Codec Systems, etc.).

- ▶ Using the provided audio cable or any custom made cable, plug the 2.5mm 3-pin connector side into the Spider’s “Audio Out” jack (located on the connector panel below the unit).
- ▶ Plug the other end of the provided cable (3.5mm 4pin connector) into your smart phone or tablet’s headphone / headset jack.
- ▶ Connect your Spider to a power source using either a USB connection (computer or the provided 5V USB power supply) or a 48V Daisy Chain Kit power supply. Your Spider is now ready for use.

USING THE SPIDER

THE DIRECTIONAL ARRAY

During a call the Spider uses a proprietary Beamforming technology to locate a legitimate voice source, and to steer an array towards it. This allows the Spider to focus on the speaker in the room and to cancel out all other noises.

The Beamforming process is dynamic and adjusts the direction of the array when the source of sound changes or moves. When in a call and a voice is detected in the room, a single or multiple blue lights located under the grill will indicate which direction the Spider’s audio beam is



focusing on. This is the direction that will be heard best by the far-end of the call (the person you are talking to).

NOTE: This function can be disabled (see below).

VOLUME CONTROL

Adjust the volume levels for the Spider's different volume profiles listed below:

SPEAKER

Change the speaker volume by using  to increase, or  to decrease the volume.

MICROPHONE

Change the microphone sensitivity by using  to increase, or  to decrease the sensitivity.

NOTE: If the sensitivity is set too low you won't be heard by the far-end. However, if the sensitivity is set too high, the far-end might get a distorted signal.

MICROPHONE MUTE



In order to mute the Spider's microphones during a call, press the  button located on the bottom right of the keypad. When muted, a MUTE symbol will appear on the screen and all the grill lights will flash red.

To UNMUTE, just press the  button again.

DISPLAY

GRILL LIGHT

When using the device, blue LED lights located under the grill will show the direction of the Spider's Beamforming mechanism. This indicates to the user which direction the Spider is "listening" to. These same lights will blink red when the device's microphones are muted.

In order to disable the grill light function, press and hold both the  AND  buttons for three seconds.

To enable the feature, just repeat the process.

VOLUME LEVEL INDICATOR

The LED bar, which is located below the buttons, represents the volume level currently being adjusted.

CONNECTING AN EXTERNAL MIC AND SPEAKER

MICROPHONE ONLY

Connect the external microphone to the 3.5mm connector using a 3-pin to 4-pin adapter (the same adapter that is used to connect a standard microphone to a Smart device). Select “External Microphone” in the “Audio Jack Setting” of the Audio Setup Utility. The unit’s internal speaker and microphones will continue working, along with the external microphone.

SPEAKERS ONLY (OR HEADPHONES)

Connect the external speakers to the 3.5mm connector. The unit’s built-in speaker will be muted. Make sure that the “Headset” option is selected in the “Audio Jack Setting” of the Audio Setup Utility (this should be the default).

MICROPHONE AND SPEAKERS (OR HEADPHONES WITH MIC)

Connect your headset into the 3.5mm connector, making sure that the “Headset” option is selected in the “Audio Jack Setting” of the Audio Setup Utility (this should be the default.) If you would like to use external speakers and a microphone, wire them the same way a standard Smart Phone mic’d headphone would be wired.

NOTE: Standard wiring: tip → left, ring1 → right, ring2 → ground, sleeve → mic-in

PRIVACY MODE

When using a mic'd headset, you can utilize the standard headset button to toggle between Privacy Mode (Headset Audio) and Speakerphone Mode. This allows you to leave your headset (or handset) plugged into the device when using the Spider's built-in microphone and speaker. When in Privacy Mode the two front red LEDs will blink.

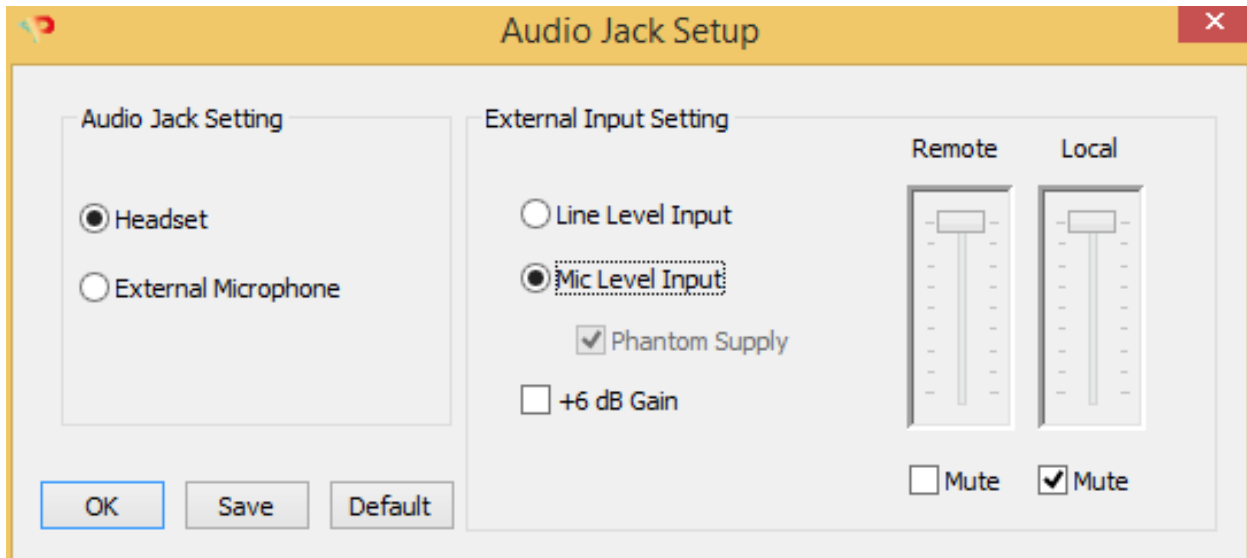

DAISY CHAINING

Every Spider comes with a built in ability to connect to other SMART Spiders (MT503) or Quattro3s (up to 15 units). This feature enables you to provide coverage for larger spaces using a chain of units.

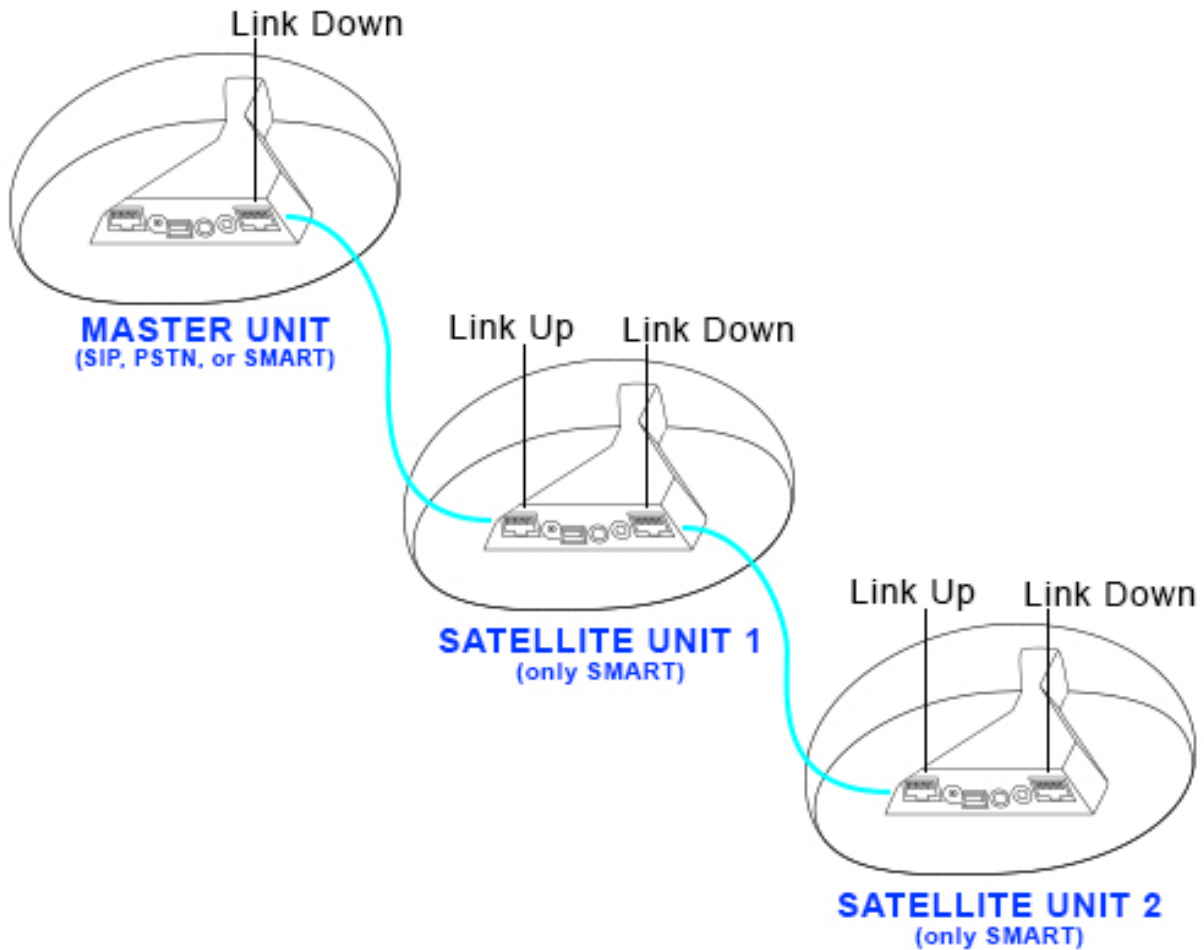

MAKING THE CONNECTION

- ▶ The SMART Spider can be both a master unit as well as a satellite, however you can use other units as masters. The master unit will be the only unit communicating with an external device, while all other units will connect and communicate only with each other.
- ▶ Using either the provided daisy chain cable or any other Ethernet cable, connect one of the cable ends to the master unit's daisy chain **DOWN** connector (the RJ45 connector marked "Link Down").
- ▶ Take the other end of the cable and connect it to the next unit's daisy chain **UP** connector (the RJ45 connector marked "UP" or "Link Up").
- ▶ Repeat the process in order to connect a third unit to unit number 2. This process can be repeated with up to 15 units regardless of their interface type. All units in the chain must be Quattro3s or Spiders.

NOTE: The MT505 and MT502 can only be the master unit, or the first unit in the chain.

POWERING THE DAISY CHAIN

Every unit in the chain must be powered. In order to do this, there are two available options:

OPTION 1

Power each unit separately, using its own provided USB cable, DC power supply, or internal battery (if applicable).

OPTION 2

Power only the master unit using the "Daisy Chain Power Kit" (MT320). This setup will require you to connect only the first unit to a power source, and will allow the rest of the units to feed off the master unit via the Ethernet daisy chain cables.

NOTE: While any Spider or Quattro3 can be daisy chained (regardless of interface), the power daisy chain method requires all units in the chain to have some type of secondary interface card (ONLY Quattro3 MT301 will not work). The power daisy chain method will work with up to 8 consecutive units before requiring another power source. The power source can be placed anywhere in the chain (first, last, or middle units).

SPECIFICATIONS

USB interface (micro B connector)

- 3.5mm external loudspeaker and microphone jack
- Daisy chain expandability of up to 15 units
- Three-way bridging capability
- Frequency response 50Hz – 16KHz
- Low latency (10ms)
- Broadcast level (peak): 92dB SPL @1m (5 watts RMS)
- Noise cancellation > 10dB (without pumping noise)
- 100% full duplex – no attenuation (in either direction) during full duplex
- High-end performance conforms to ITU-T G.167
- Acoustic echo cancellation > 40dB with conversion speed of 40dB/sec
- Residual echo is suppressed to the environment noise level, preventing artificial ducking of signal
- 4 high-quality directional microphones
- Direction-finding algorithm (determines the presence and direction of a speaker)
- Beam-forming algorithm (forms and directs audio beams towards a defined direction)
- Automatic voice-level adjustment (AGC)
- Line-echo canceler active when telephone interface is present
- Metal case and metal grill mesh for high RFI immunity and product durability

Dimensions:	<i>Length: 7" Width: 7" Height: 2.75"</i>
Weight:	<i>2.15 lbs.</i>
Power Consumption:	<i>5V 500mA through USB or wall mount ac/dc adaptor</i>
Software:	<i>Plug- and -Play. No installation or drivers.</i> Note: Audio Setup Utility is available for Windows. The setup utility helps monitor the audio input and output level but is not required.
Operating Systems:	<i>Windows 98 and up / Linux / MacOS.</i>

Complies with FCC 47 CFR Part 68, and ACTA adopted technical criteria: TIA-968-A

Complies with FCC 47CFR Part 15; ICES-003: 2004 Issue 4, Class B; AS/NZS CISPR 22: 2006, Class B; EN 55022: 1998+A1(00)+A2(03), Class B; EN61000-3-2: 2000+A2(05); EN61000-3-3: 1995+A2(05); EN55024: 1998+A1(01)+A2(03)

Complies with ETSI EG 201 121 V1.1.3 (2000-02); ETSI ES 203 021-2 V2.1.2 (2006-01); ETSI ES 203 021-3 V2.1.2 (2006-01)

Conforms to the requirement of the European Union Directive 2002/95EC (RoHS Directive)

WARRANTY

The following warranty statement is effective for all Phoenix Audio Technologies' products as of October 1st, 2007

Phoenix Audio Technologies warrants that this product is free of defects in both materials and workmanship. Should any part of this product be defective, the Manufacturer agrees, at its option, to repair or replace with a like new replacement any defective part(s) free of charge (except transportation charges) for a period of two years for all products. This warranty period begins on the date the end user is invoiced for the product, provided the end user provides proof of purchase that the product is still within the warranty period and returns the product within the warranty period to Phoenix Audio Technologies or an authorized Phoenix Audio Technologies dealer according to the Product Return and Repair Policy listed below. All inbound shipping costs are the responsibility of the end user, Phoenix Audio Technologies will be responsible for all outbound shipping costs.

Product Return and Repair Policy

1. Return to seller if purchased through an authorized dealer
 - a. Proof of purchase date from reseller within warranty period must be provided by the end user
 - b. Seller may, at its discretion, provide an immediate exchange or repair or may return the unit to the Manufacturer for repair
2. Return to Manufacturer
 - a. An RMA (return merchandise authorization) number must be obtained by the end user from Phoenix Audio Technologies
 - b. The end user must return the product to Phoenix Audio Technologies with proof of purchase (showing purchase date) for a warranty claim, and display the RMA number on the outside of the shipping package

THIS WARRANTY IS VOID IF:

The product has been damaged by negligence, accident, act of God, or mishandling, or has not been operated in accordance with the procedures described in the operating and technical instructions; or; The product has been altered or repaired by other than the Manufacturer or an authorized service representative of the Manufacturer; or; Adaptations or accessories other than those manufactured or provided by the Manufacturer have been made or attached to the product which, in the determination of the Manufacturer, shall have affected the performance, safety or reliability of the product; or; The product's original serial number has been modified or removed.

NO OTHER WARRANTY, EXPRESS OR IMPLIED, INCLUDING WARRANTIES OF MERCHANTABILITY OR FITNESS FOR ANY PARTICULAR USE, APPLIES TO THE PRODUCT. MANUFACTURER'S MAXIMUM LIABILITY HEREUNDER SHALL BE THE AMOUNT PAID BY THE END USER FOR THE PRODUCT.

Manufacturer shall not be liable for punitive, consequential, or incidental damages, expenses, or loss of revenue or property, inconvenience, or interruption in operation experienced by the end user due to a malfunction in the purchased product. No warranty service performed on any product shall extend the applicable warranty period. This warranty extends only to the original end user and is not assignable or transferable. This warranty is governed by the laws of the State of California.

For more information or technical support please refer to our website www.phnxaudio.com, email us at support@phnxaudio.com, or call (818) 937-4779

Phoenix Audio Technologies, 16 Goodyear #120, Irvine, CA 92618
Email: info@phnxaudio.com, Telephone: (818) 937-4774, Fax: (818) 859-1054

