

## Install

# PRAGUE TPZ152/64

Arrayable 2 Way 15" Full Range Loudspeaker  
for Installation Applications

- Arrayable 2 way full range loudspeaker for installation applications
- Rotatable waveguide with 60° H x 40° V dispersion
- 650 Watts continuous, 2,600 Watts peak power
- Carbon fibre loaded 15" low frequency driver with inside/outside wound coil
- Titanium dome 1.4" neodymium motor compression driver
- Multiple array configurations for extended coverage
- Switchable passive/bi-amp operation for flexibility of use
- Trapezoidal cabinet shape enables visually unobtrusive loudspeaker arrays
- Multiple internal rigging points allow bracket mount and suspension in any orientation
- 15 mm (5/8") birch plywood enclosure with hard wearing semi matt black paint finish
- Architecturally styled powder coated perforated steel mesh grille
- Neutrik speakON\* NL4 and barrier strip connectors
- 10-Year Warranty Program\*
- Designed and engineered in the U.K.



The 2 way full range TPZ152/64 is a switchable passive/bi-amp 15" 2,600 Watt arrayable loudspeaker system that is ideally suited for a wide range of speech and music sound reinforcement applications. The TPZ152/64 is designed to work in conjunction with **TURBOSOUND** loudspeaker management systems, providing optimal FOH performance, as well as offering considerable flexibility to readily adapt to varying venue requirements.



The TPZ152/64 arrayable loudspeaker features a carbon fibre loaded 15" low frequency driver with inside/outside wound coil with low mass voice coil for improved transient response, and a titanium dome 1.4" neodymium motor high frequency compression driver mounted on a rotatable 60° horizontal by 40° vertical waveguide. All drivers are matched with an internal passive crossover network in a reflex-loaded enclosure, and bi-amp mode can be enabled by means of a rear panel switch.

Finished in a highly durable semi matt black paint, the cabinet is constructed from 15 mm (5/8") birch plywood – and includes a rugged powder coated perforated steel mesh grille backed with reticulated foam. Internal M10 threaded rigging points are provided for suspension in any orientation, or mounting with dedicated brackets – available separately. The rear panel connector plate carries Neutrik speakON\* NL4 and barrier strip connectors for input and link connections to additional enclosures.

\*All third-party trademarks are the property of their respective owners. Their use neither constitutes a claim of the trademark nor affiliation of the trademark owners with MUSIC Tribe. Product names are mentioned solely as a reference for compatibility, effects and/or components. Warranty details can be found at musictribe.

Install

# PRAGUE

## TPZ152/64

Arrayable 2 Way 15" Full Range Loudspeaker  
for Installation Applications



### You Are Covered

We always strive to provide the best possible Customer Experience. Our products are made in our own [MUSIC Tribe](#) factory using state-of-the-art automation, enhanced production workflows and quality assurance labs with the most sophisticated test equipment available in the world. As a result, we have one of the lowest product failure rates in the industry, and we confidently back it up with a generous [Warranty program](#).

Install

# PRAGUE

## TPZ152/64

Arrayable 2 Way 15" Full Range Loudspeaker  
for Installation Applications

### Frequency Response Sensitivity 1 W / 1 m

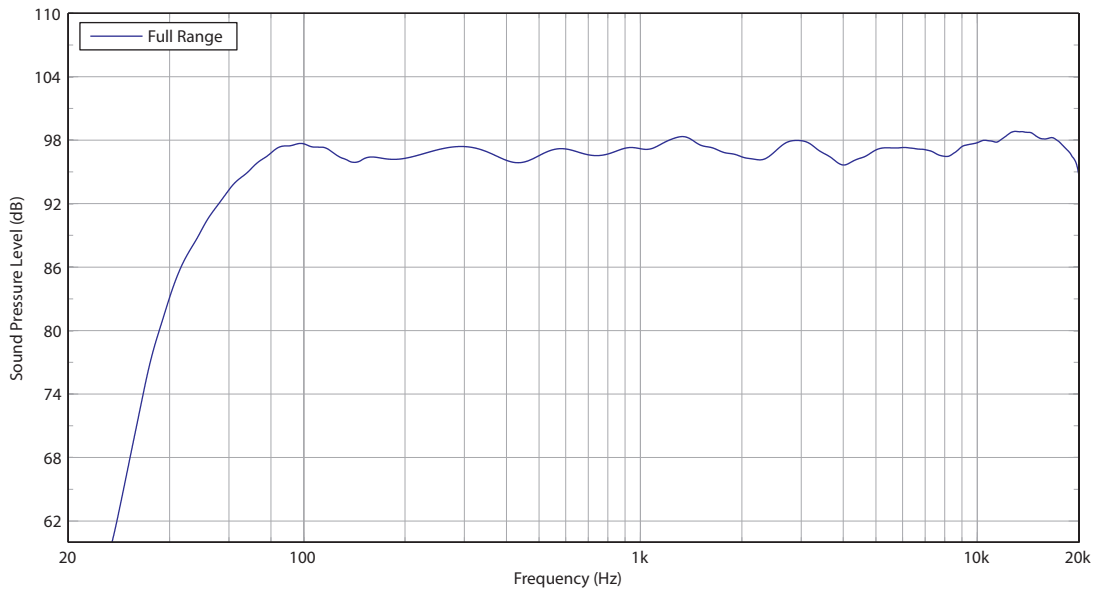

### Impedance

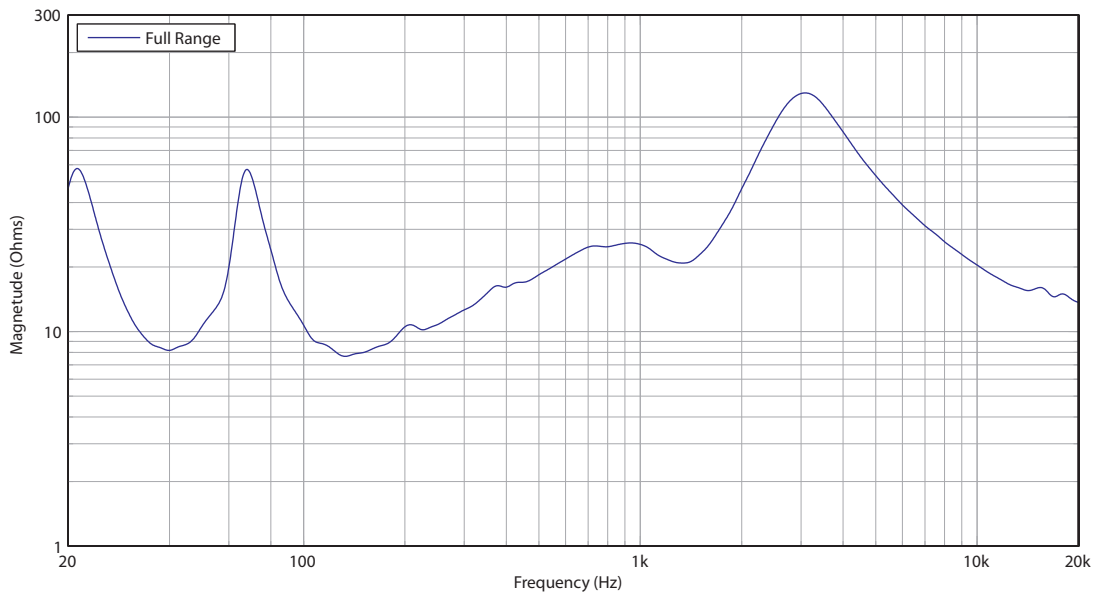

Install

# PRAGUE

## TPZ152/64

Arrayable 2 Way 15" Full Range Loudspeaker  
for Installation Applications

### Horizontal Beamwidth

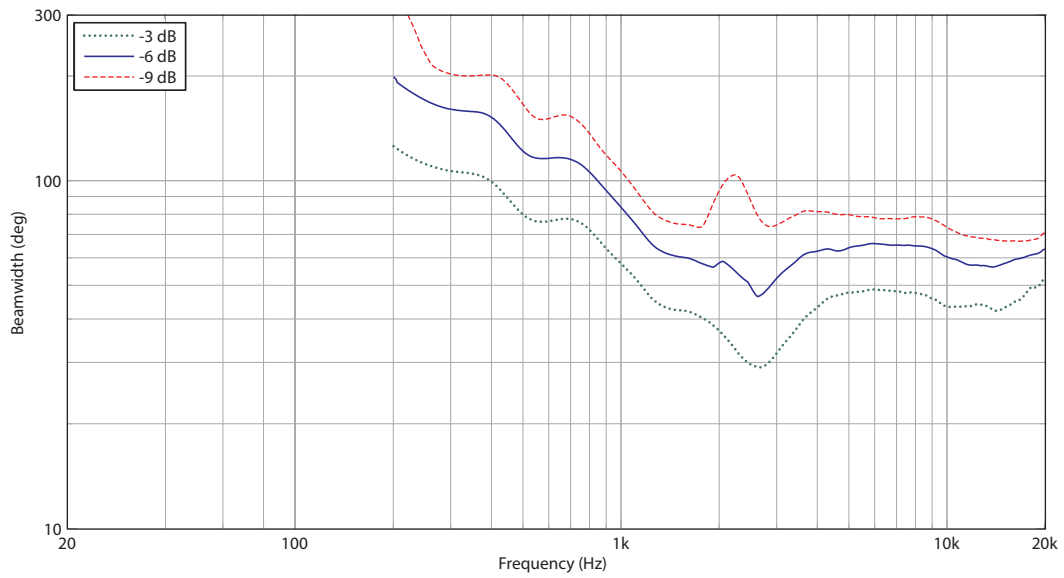

### Vertical Beamwidth

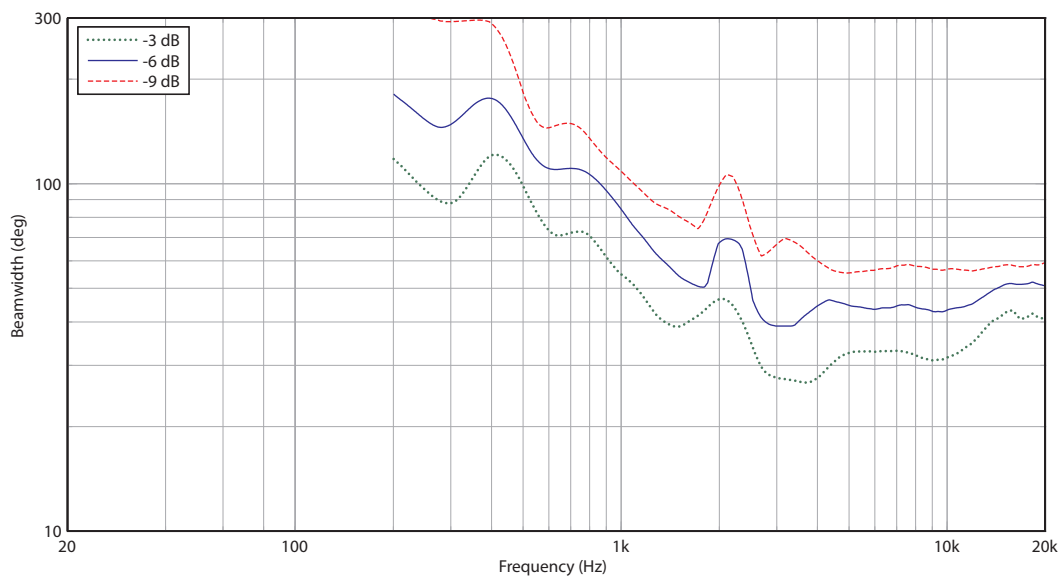

Install

# PRAGUE TPZ152/64

Arrayable 2 Way 15" Full Range Loudspeaker  
for Installation Applications

## Horizontal Polar Plots

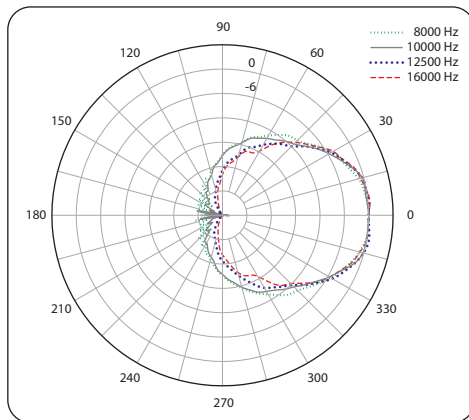
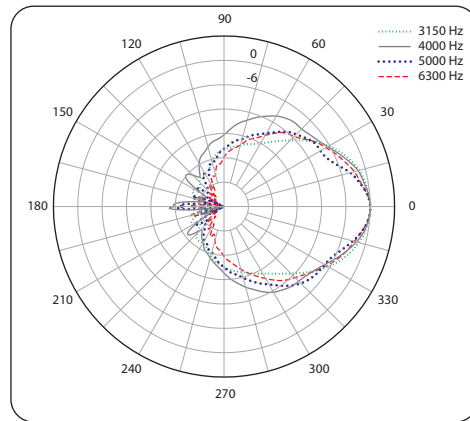
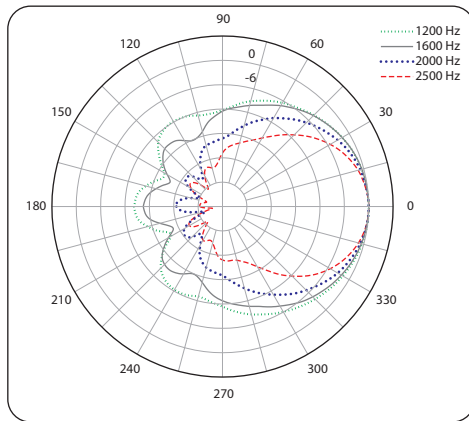
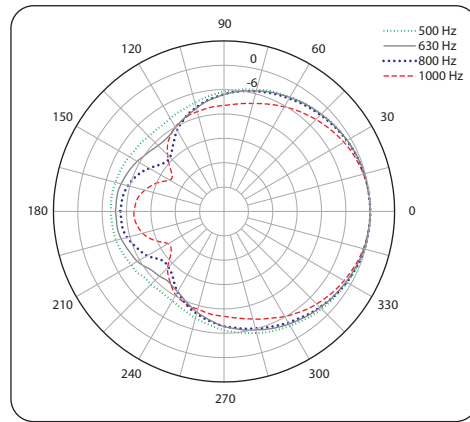
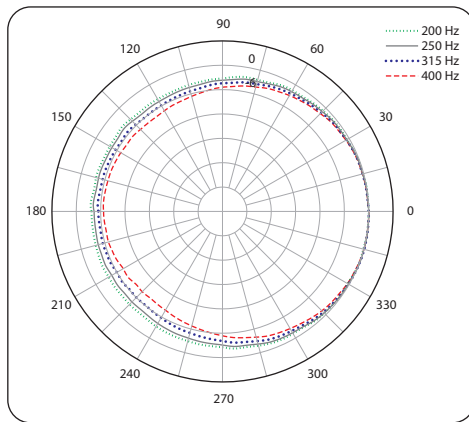

Install

# PRAGUE TPZ152/64

Arrayable 2 Way 15" Full Range Loudspeaker  
for Installation Applications

## Vertical Polar Plots

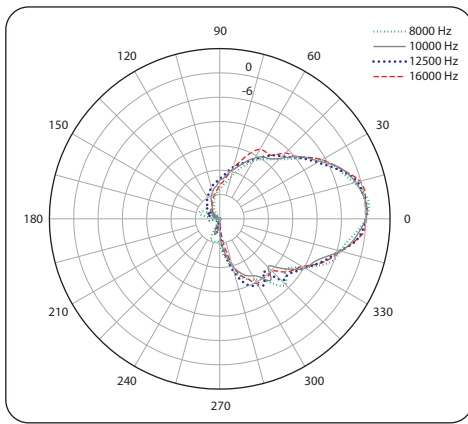
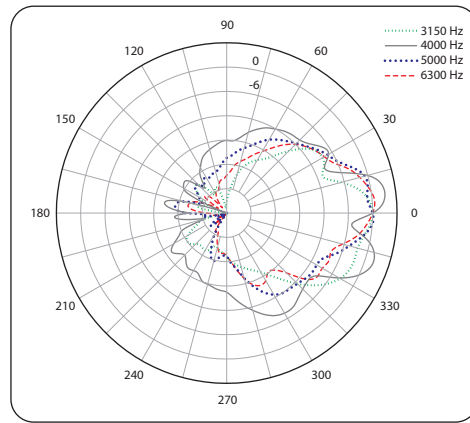
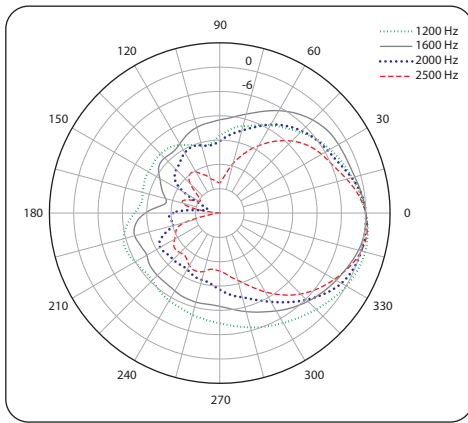
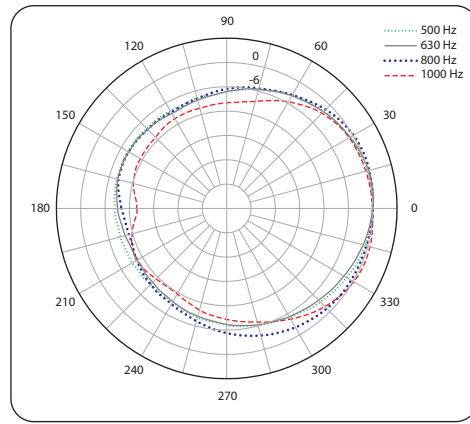
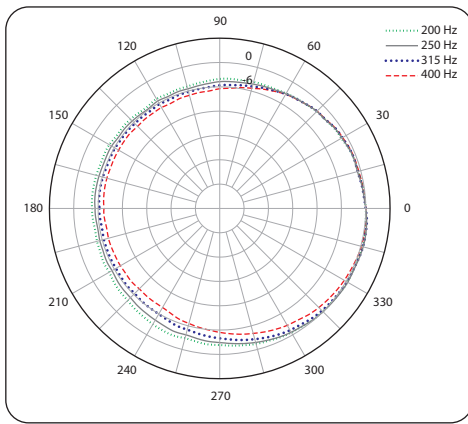

Install

# PRAGUE TPZ152/64

Arrayable 2 Way 15" Full Range Loudspeaker  
for Installation Applications

## Dimensions

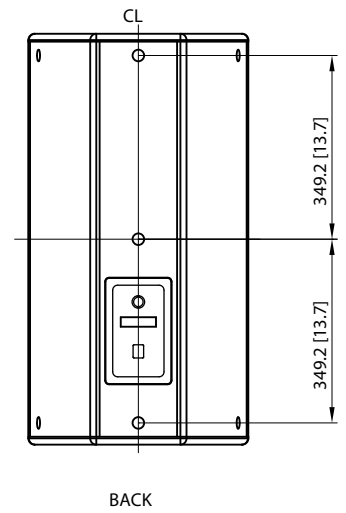
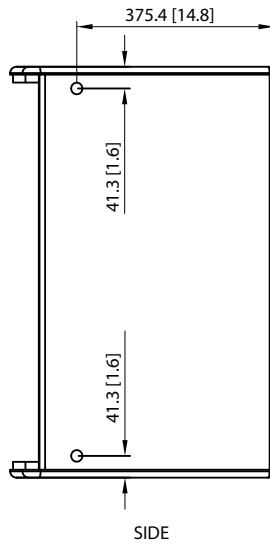
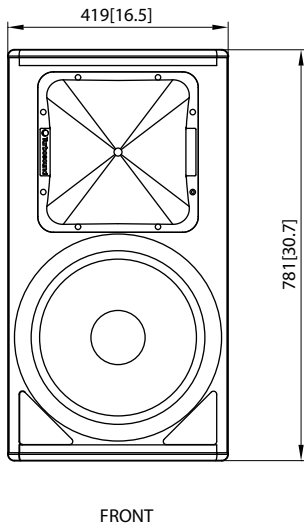
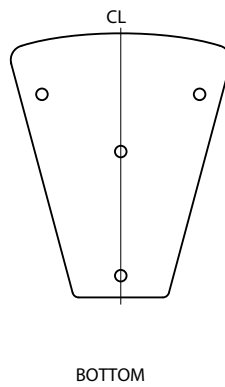
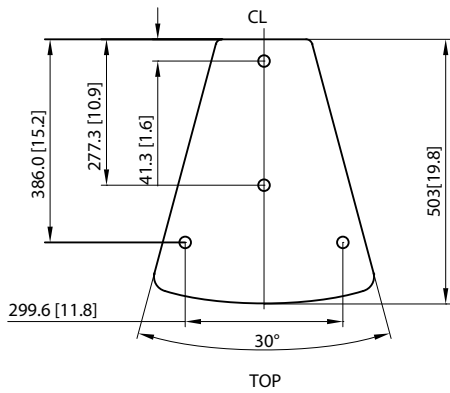

Install

# PRAGUE

## TPZ152/64

Arrayable 2 Way 15" Full Range Loudspeaker  
for Installation Applications

### Mounting and Rigging

The cabinet is fitted with a quantity of 15 M10 internally-threaded rigging points on the top, bottom, sides and rear, that allow it to be rigged with M10 eyebolts and mounted in a variety of ways to suit differing applications.

An adjustable wall bracket (TPA152-WB) enables the cabinet to be fixed to a ceiling or wall, with the ability to rotate and adjust the angle to achieve optimum coverage. (In addition, the horn may be rotated through 90 degrees to vary the dispersion if desired.)

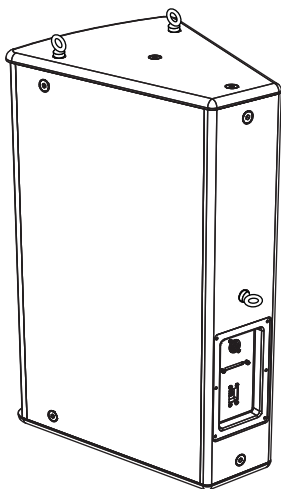
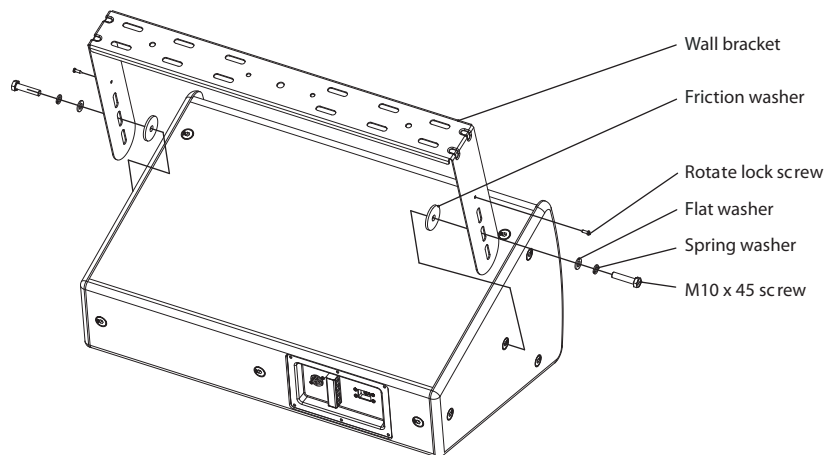

Eye-Bolt Rigging

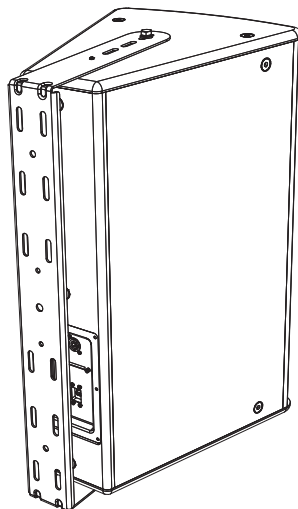

Vertical Mounting

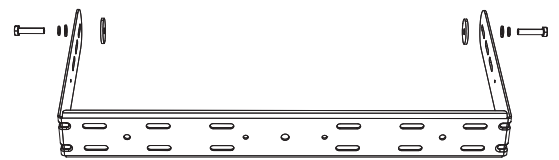

Wall Bracket Kit TPA152-WB

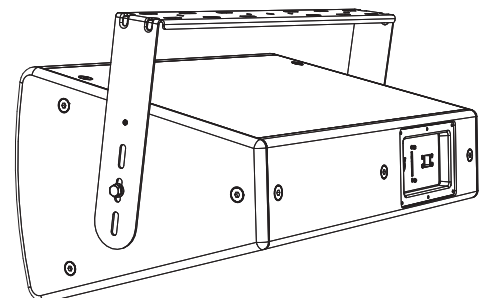

Horizontal Mounting



## Install

# PRAGUE

## TPZ152/64

Arrayable 2 Way 15" Full Range Loudspeaker  
for Installation Applications

## Technical Specifications

### System

<b>Frequency Response</b>	41 Hz – 18 kHz $\pm$ 3 dB 35 Hz – 20 kHz -10 dB
<b>Nominal Dispersion</b>	60° H X 40° V @ -6 dB points, rotatable
<b>Directivity Factor (Q)</b>	18.3
<b>Directivity Index (DI)</b>	12.6
<b>Power Handling (IEC)</b>	
Passive	650 W continuous, 2,600 W peak
Bi-amp	LF: 650 W continuous, 2,600 W peak HF: 75 W continuous, 300 W peak
<b>Sensitivity</b>	97 dB (1 W @ 1 m)
<b>Maximum SPL</b>	
Passive	125 dB continuous, 131 dB peak
Bi-Amp	LF: 125 dB continuous, 131 dB peak HF: 128 dB continuous, 134 dB peak
<b>Impedance</b>	
Passive	8 $\Omega$
Bi-Amp	LF: 8 $\Omega$ HF: 6 $\Omega$
<b>Crossover Type</b>	Passive / bi-amp switchable
<b>Components</b>	1 x 15" (394 mm) LF driver 1 x 1.4" (36 mm) HF compression driver

### Enclosure

<b>Connectors</b>	1 x Neutrik speakON* NL4, 1 x barrier strip terminals
<b>Wiring</b>	
Passive	Pins 1+ / 1- input, pins 2+ / 2- link
Bi-Amp	Pins 1+ / 1- LF, pins 2+ / 2- HF
<b>Dimensions HWD</b>	781 x 419 x 503 mm (30.7 x 16.5 x 19.8")
<b>Net Weight</b>	26.8 kg (59.0 lbs)
<b>Construction</b>	15 mm (5/8") birch plywood
<b>Finish</b>	Semi matt black paint
<b>Grille</b>	Powder coated perforated steel
<b>Flying Hardware</b>	M10 x 15 points

### Accessories

TPA152-WB wall bracket PRAGUE 15"

## Install

# PRAGUE

## TPZ152/64

Arrayable 2 Way 15" Full Range Loudspeaker  
for Installation Applications

### Architecture & Engineering Specifications

The speaker shall be of the full range, two-way switchable bi-amp/passive type consisting of one 15" (394 mm) LF driver and one 1.4" (36 mm) HF compression driver. Performance specifications of a typical production unit shall meet or exceed the following: frequency response, measured with swept sine wave input, shall be flat within  $\pm 3$  dB from 41 Hz to 18 kHz and within -10 dB from 35 Hz to 20 kHz. Nominal dispersion, at -6 dB points, shall average 60° H x 40° V, rotatable. Nominal impedance shall be HF: 6 Ohms, LF: 8 Ohms; passive: 8 Ohms. Power handling shall be HF: 75 Watts continuous, 300 Watts peak, LF: 650 Watts continuous, 2,600 Watts peak; passive: 650 Watts continuous, 2,600 Watts peak. Sensitivity, measured on axis, mean averaged over stated bandwidth, shall be 97 dB, 1 Watt @ 1 metre. Maximum SPL (peak), measured at 1 metre with music program at stated amplifier input, shall be HF: 134 dB, LF: 131 dB; passive: 131 dB. Dimensions: 781 mm high x 419 mm wide x 503 mm deep (30.7" x 16.5" x 19.8"). Net weight: 26.8 kg (59.0 lbs). The loudspeaker system shall be the [TURBOSOUND TPZ152/64](#). No other loudspeaker shall be acceptable unless submitted data from an independent test laboratory verifies that the above combined performance / size specifications are equaled or exceeded.

Install

# PRAGUE TPZ152/64

Arrayable 2 Way 15" Full Range Loudspeaker  
for Installation Applications



Install

# PRAGUE TPZ152/64

Arrayable 2 Way 15" Full Range Loudspeaker  
for Installation Applications

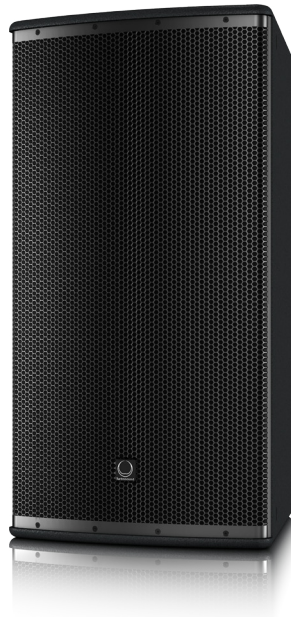

Install

# PRAGUE TPZ152/64

Arrayable 2 Way 15" Full Range Loudspeaker  
for Installation Applications



For service, support or more information contact the TURBOSOUND location nearest you:

**Europe**  
**MUSIC Tribe Brands UK Ltd.**  
 Tel: +44156 273 2290  
 Email: CARECrea@music-group.com  
 CAREEnte@music-group.com  
 CARELife@music-group.com

**USA/Canada**  
**MUSIC Tribe Commercial NV Inc.**  
 Tel: +1 702 800 8290  
 Email: CARECrea@music-group.com  
 CAREEnte@music-group.com  
 CARELife@music-group.com

**Japan**  
**MUSIC Tribe Services JP K.K.**  
 Tel: +81 3 6231 0453  
 Email: CARECrea@music-group.com  
 CAREEnte@music-group.com  
 CARELife@music-group.com

MUSIC Tribe accepts no liability for any loss which may be suffered by any person who relies either wholly or in part upon any description, photograph, or statement contained herein. Technical specifications, appearances and other information are subject to change without notice. All trademarks are the property of their respective owners. MIDAS, KLARK TEKNIK, LAB GRUPPEN, LAKE, TANNÖY, TURBOSOUND, TC ELECTRONIC, TC HELICON, BEHRINGER, BUGERA and COOLAUDIO are trademarks or registered trademarks of MUSIC Tribe Global Brands Ltd. © MUSIC Tribe Global Brands Ltd. 2018 All rights reserved.