

PLUTO 200

USER MANUAL

 [®] PLUTO 200
SS658

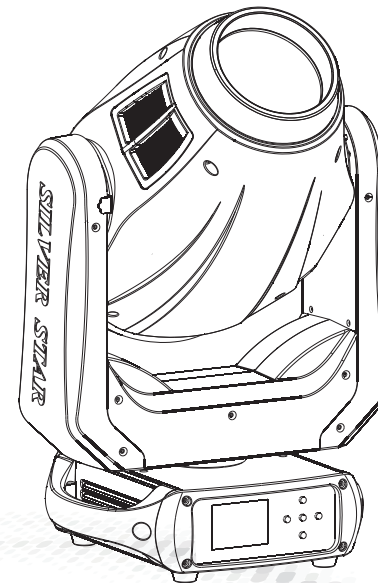

MODEL:SS658SC



广州市雅江光电设备有限公司

Guangzhou Yajiang Photoelectric Equipment Ltd.

电话/Tel : 020-86947788 邮箱/E-mail : sales@yajiang.cn

传真/Fax : 020-86943773 网址/Website : www.yajiang.cn

— Since 1985 —

RD-SS658-SM-00(SS-I)

1 Product specifications

1.1 Technical specifications

LED Module:

- ◆ Voltage: AC100V–240V, 50/60Hz
- ◆ Power: 280W
- ◆ Dimension: 359x249x555mm
- ◆ Weight: 16.5Kg

1.2 Dimensions

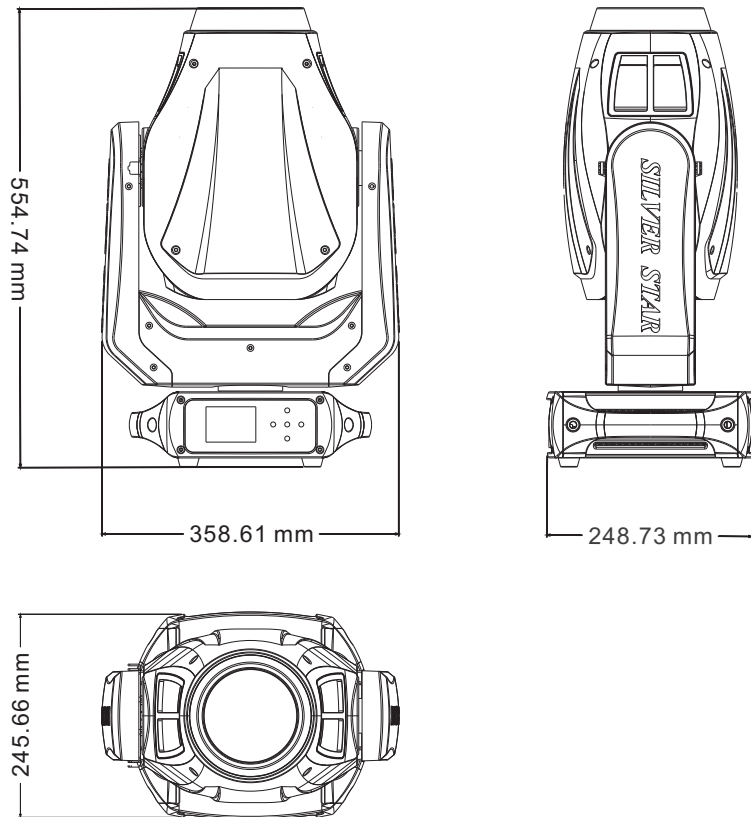

CHANNEL	VALUE	FUNCTION
	241 ↔ 250	FOCUS\ZOOM\FROST\PRISM RESET
	251 ↔ 255	NO FUNCTION

1.2 Safety warning

IMPORTANT

Always read the user manual before operation.

Please confirm that the power supply stated on the product is the same as the mains power supply in your area.

- This product must be installed by a qualified professional.
- Always operate the equipment as described in the user manual.
- A minimum distance of 0.5m must be maintained between the equipment and combustible surface.
- The product must always be placed in a well ventilated area.
- Always make sure that the equipment is installed securely.
- Do not stand close to the equipment and stare directly into the LED light source.
- Always disconnect the power supply before attempting and maintenance.
- Always make sure that the supporting structure is solid and can support the combined weight of the products.
- The earth wire must always be connected to the ground.
- Do not touch the power cables if your hands are wet.

ATTENTION



- This product left the place of manufacture in perfect condition. In order to maintain this condition and for safe operation, the user must always follow the instructions and safety warnings described in this user manual.
- Avoid shaking or strong impacts to any part of the equipment.
- Make sure that all parts of the equipment are kept clean and free of dust.
- Always make sure that the power connections are connected correct and secure.
- If there is any malfunction of the equipment, contact your distributor immediately.
- When transferring the product, it is advisable to use the original packaging in which the product left the factory.
- Shields, lenses or ultraviolet screens shall be changed if they have become damaged to such an extent that their effectiveness is impaired.
- The lamp (LED) shall be changed if it has become damaged or thermally deformed.



Caution, risk of electric shock
The light source contained in this luminaire shall only be replaced by the manufacturer or his service agent or a similar qualified person.

2 Installation

2.1 Mounting

- The fixture can be mounted in any position.
- Always ensure that mounting surface can withstand 10 times the weight of the fixture.
- Always use a safety cable when mounting the fixture in any elevated position.

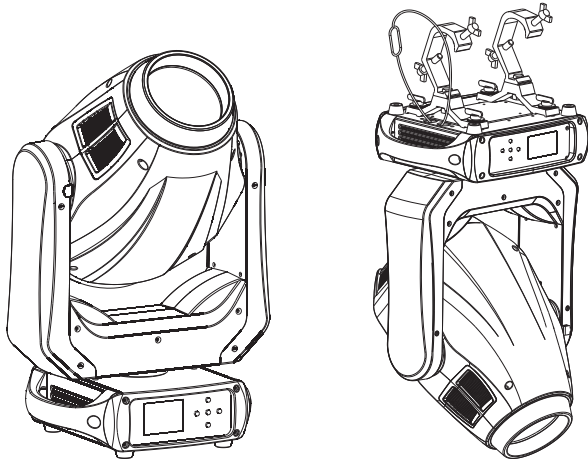

UPRIGHT

HANGING

IMPORTANT SAFETY NOTE!!

Always use a safety cable when installing this unit!!
Be sure that the safety cable is connected to a solid load-bearing structure.

CHANNEL	VALUE	FUNCTION
CH.13	94 ↔ 120	11M
	121 ↔ 147	13M
	148 ↔ 174	15M
	175 ↔ 201	17M
	202 ↔ 228	19M
	229 ↔ 255	21M
CH.14	0 ↔ 255	MANUAL FOCUS
CH.15	0 ↔ 255	DIMMER
STROBE		
CH.16	0 ↔ 9	NO FUNCTION
	10 ↔ 99	STROBE (FROM SLOD TO FAST , 0-25Hz)
	100 ↔ 109	NO FUNCTION
	110 ↔ 179	LIGHTNING STROBE
	180 ↔ 189	NO FUNCTION
	190 ↔ 255	RANDOM SROBE
CONTROL		
CH.17	000 ↔ 010	NO FUNCTION
	011 ↔ 020	PAN/TILT BLACK ACTIVATED
	021 ↔ 030	PAN/TILT BLACK DEACTIVATED
	031 ↔ 040	PAN INVERT
	041 ↔ 050	TILT INVERT
	051 ↔ 060	PAN/TILT INVERT OFF
	061 ↔ 070	FAN SLOW
	071 ↔ 080	FAN NORMAL
	081 ↔ 090	FAN FAST
	091 ↔ 100	FAN AUTO
	101 ↔ 110	DIM4
	111 ↔ 120	DIM3
	121 ↔ 130	DIM2
	131 ↔ 140	DIM1
	141 ↔ 150	DIM OFF
	151 ↔ 160	1200Hz
	161 ↔ 170	2400Hz
	171 ↔ 180	4000Hz
	181 ↔ 190	6000Hz
	191 ↔ 200	25000Hz
	201 ↔ 210	ALL RESET
	211 ↔ 220	XY RESET
	221 ↔ 230	COLOR SYSTEM RESET
231 ↔ 240	GOBO RESET	

CHANNEL	VALUE	FUNCTION
	083 ↔ 090	ROTATING GOBO 3 SHAKE (SPEED 1 → 100%)
	091 ↔ 098	ROTATING GOBO 4 SHAKE (SPEED 1 → 100%)
	099 ↔ 106	ROTATING GOBO 5 SHAKE (SPEED 1 → 100%)
	107 ↔ 114	ROTATING GOBO 6 SHAKE (SPEED 1 → 100%)
	115 ↔ 122	ROTATING GOBO 7 SHAKE (SPEED 1 → 100%)
	123 ↔ 127	WHITE
	128 ↔ 190	ROTATING GOBO FLOWING WATER EFFECT (SPEED 100 → 1%)
	191 ↔ 192	STOP WATER EFFECT
	193 ↔ 255	ROTATING GOBO FLOWING WATER EFFECT (SPEED 1 → 100%)
	GOBO ROTATING	
	0 ↔ 120	ROTATING GOBO ANGLE ADJUSTMENT (0 → 360°)
	121 ↔ 125	STOP
	126 ↔ 165	ROTATING GOBO SHAKE (SPEED 1 → 100%)
CH.8	166 ↔ 170	STOP
	171 ↔ 210	ROTATING GOBO POSITIVE ROTATION (SPEED 100% → 1)
	211 ↔ 215	STOP
	216 ↔ 255	ROTATING GOBO REVERSE ROTATION (SPEED 1 → 100%)
	PRISM	
	0 ↔ 10	WHITE
	11 ↔ 145	PRISM INSERT AND ADJUST THE ANGLE (0 → 360°)
CH.9	146 ↔ 150	STOP
	151 ↔ 200	PRISM INSERT AND POSITIVE ROTATION (SPEED 100% → 1)
	201 ↔ 205	STOP ROTATION
	206 ↔ 255	PRISM INSERT AND REVERSE ROTATION (SPEED 1 → 100%)
	FROST LENS	
CH.10	0 ↔ 10	WHITE
	11 ↔ 251	FROST LENS (0-100%)
	252 ↔ 255	FROST LENS (100%)
	IRIS	
	0 ↔ 127	IRIS OPEN → CLOSE (FROM LARGE TO SMALL)
	128 ↔ 130	IRIS CLOSE
	131 ↔ 171	IRIS FAST IN FAST OUT (SPEED 1 → 100%)
	172 ↔ 211	IRIS FADE IN FADE OUT RANDOMLY (SPEED 1 → 100%)
CH.11	212 ↔ 251	IRIS FAST IN FADE OUT RANDOMLY (SPEED 1 → 100%)
	252 ↔ 255	IRIS CLOSE
	0 ↔ 255	ZOOM
	AUTO ZOOM	
	0 ↔ 12	NO FUNCTION
	13 ↔ 39	5M
	40 ↔ 66	7M
	67 ↔ 93	9M

2.2 Fuse replacement

- Remove the safety cap by a screwdriver.
- Fetch the old fuse from safety cap.
- Install a new fuse.
- Install the safety cap.

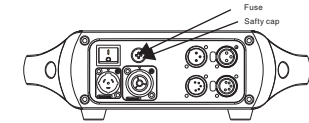

2.3 Power connections

This product uses input and output power cable is 1.5 square mm copper wire
Note:

If the signal cable is over 60m between the DMX512 controller and fixture or between two fixtures, then a DMX signal amplifier is needed as well.

This product provides for the use of input power and signal cables are three-core, the connection diagram is as follows

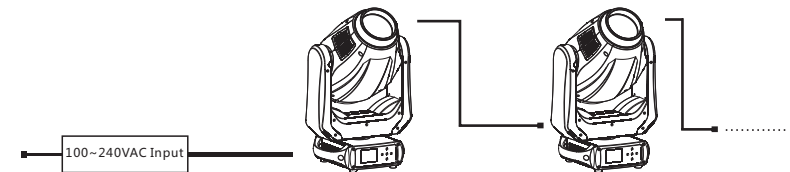

- When using this product to connect 220V AC, the number of tandem fixtures must not exceed ten.
- When using this product to connect 110V AC, the number of tandem fixtures must not exceed five.

3 Display panel operation

3.1 Display operation

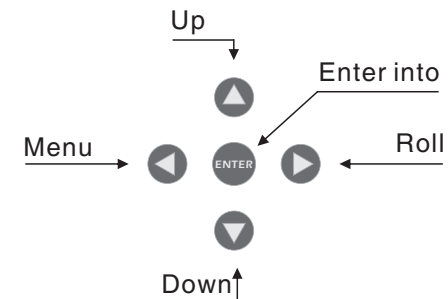

3.2 Menu

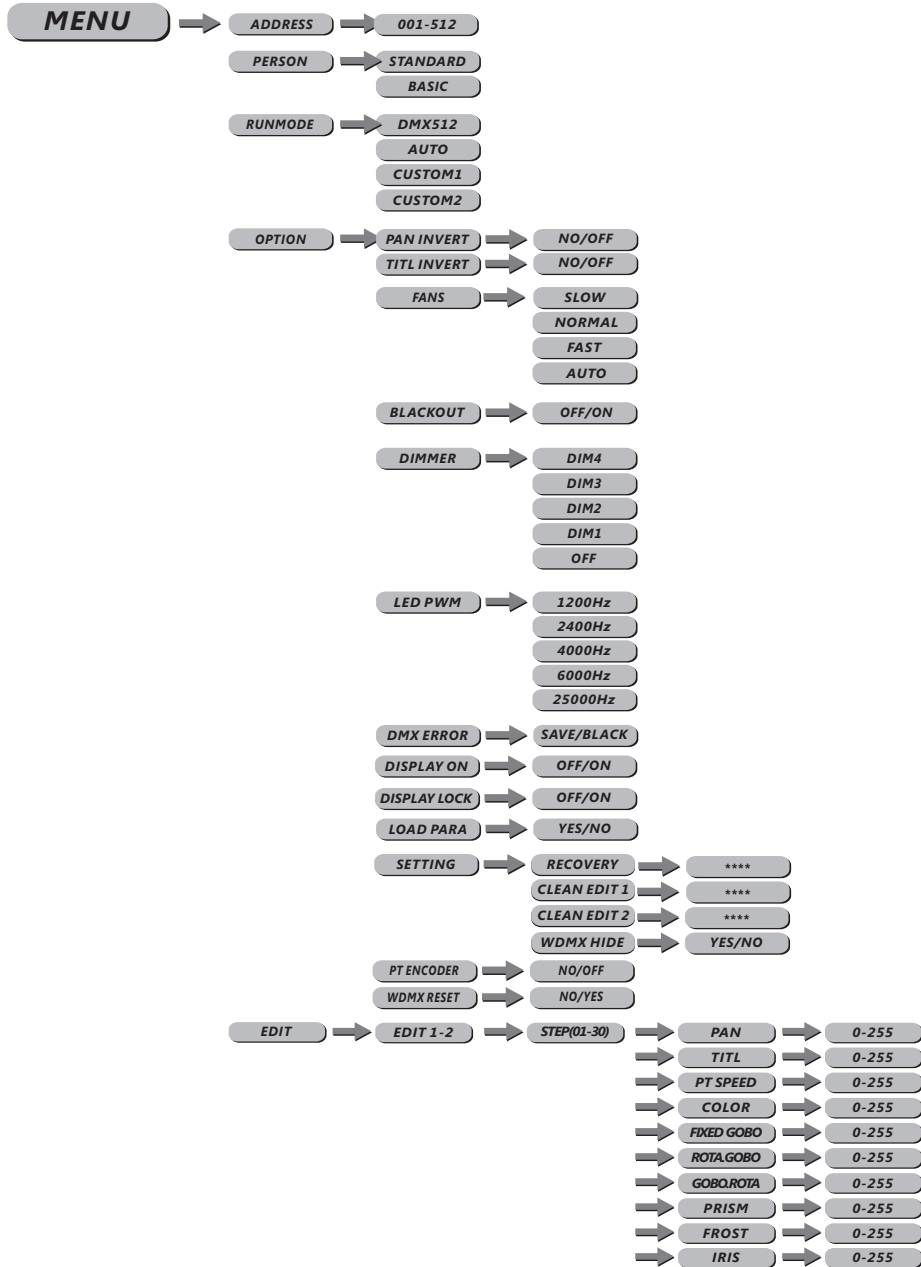

CHANNEL	VALUE	FUNCTION
	192 ↔ 222	COLOR WHEEL RAINBOW EFFECT (SPEED 100%-> 1)
	223 ↔ 224	STOP
	225 ↔ 255	COLOR WHEEL RAINBOW EFFECT (SPEED 1-> 100%)
CH.5	000 ↔ 255	COLOR WHEEL FINE ADJUSTMENT.
	FIXED GOBO WHEEL	
	0 ↔ 10	WHITE
	11 ↔ 17	FIXED GOBO WHEEL 1
	18 ↔ 24	FIXED GOBO WHEEL 2
	25 ↔ 31	FIXED GOBO WHEEL 3
	32 ↔ 38	FIXED GOBO WHEEL 4
	39 ↔ 45	FIXED GOBO WHEEL 5
	46 ↔ 52	FIXED GOBO WHEEL 6
	53 ↔ 59	FIXED GOBO WHEEL 7
	60 ↔ 66	FIXED GOBO WHEEL 8
	67 ↔ 73	FIXED GOBO WHEEL 9
	74 ↔ 80	FIXED GOBO WHEEL 10
CH.6	81 ↔ 87	FIXED GOBO WHEEL 1 SHAKE (SPEED 1 → 100%)
	88 ↔ 94	FIXED GOBO WHEEL2 SHAKE (SPEED 1 → 100%)
	95 ↔ 101	FIXED GOBO WHEEL 3 SHAKE (SPEED 1 → 100%)
	102 ↔ 108	FIXED GOBO WHEEL 4 SHAKE (SPEED 1 → 100%)
	109 ↔ 115	FIXED GOBO WHEEL 5 SHAKE (SPEED 1 → 100%)
	116 ↔ 122	FIXED GOBO WHEEL 6 SHAKE (SPEED 1 → 100%)
	123 ↔ 129	FIXED GOBO WHEEL 7 SHAKE (SPEED 1 → 100%)
	130 ↔ 136	FIXED GOBO WHEEL 8 SHAKE (SPEED 1 → 100%)
	137 ↔ 143	FIXED GOBO WHEEL 9 SHAKE (SPEED 1 → 100%)
	144 ↔ 150	FIXED GOBO WHEEL 10 SHAKE (SPEED 1 → 100%)
	151 ↔ 200	STATIC GOBO JUMPING WATER EFFECT (SPEED 100 → 1%)
	201 ↔ 205	STOP WATER EFFECT
	206 ↔ 255	STATIC GOBO FLOWING WATER EFFECT (SPEED 1 → 100%)
	ROTATING GOBO	
	000 ↔ 010	WHITE
	011 ↔ 018	GOBO 1
	019 ↔ 026	GOBO 2
	027 ↔ 034	GOBO 3
	035 ↔ 042	GOBO 4
	043 ↔ 050	GOBO 5
	051 ↔ 058	GOBO 6
	059 ↔ 066	GOBO 7
CH.7	067 ↔ 074	ROTATING GOBO 1 SHAKE (SPEED 1 → 100%)
	075 ↔ 082	ROTATING GOBO 2 SHAKE (SPEED 1 → 100%)

CHANNEL	VALUE	FUNCTION
	041 ↔ 050	TILT INVERT
	051 ↔ 060	PAN/TILT INVERT OFF
	061 ↔ 070	FAN SLOW
	071 ↔ 080	FAN NORMAL
	081 ↔ 090	FAN FAST
	091 ↔ 100	FAN AUTO
CH.20	101 ↔ 110	DIM4
	111 ↔ 120	DIM3
	121 ↔ 130	DIM2
	131 ↔ 140	DIM1
	141 ↔ 150	DIM OFF
	151 ↔ 160	1200Hz
	161 ↔ 170	2400Hz
	171 ↔ 180	4000Hz
	181 ↔ 190	6000Hz
	191 ↔ 200	25000Hz
	201 ↔ 210	ALL RESET
	211 ↔ 220	XY RESET
	221 ↔ 230	COLOR SYSTEM RESET
	231 ↔ 240	GOBO RESET
	241 ↔ 250	FOCUS\ZOOM\FROST\PRISM RESET
	251 ↔ 255	NO FUNCTION

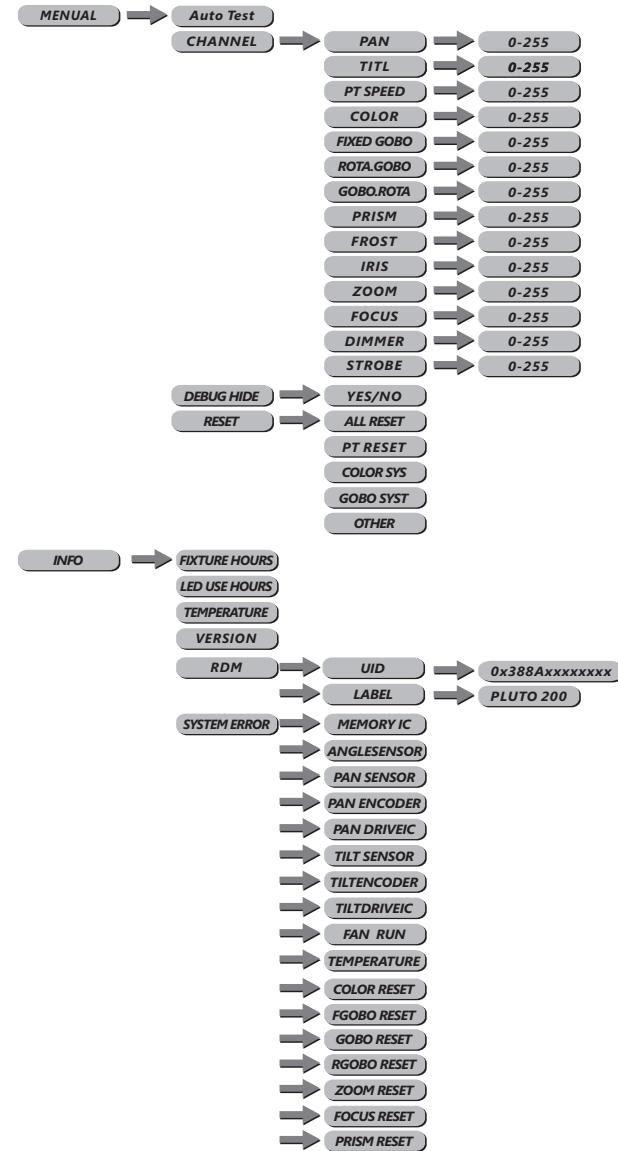
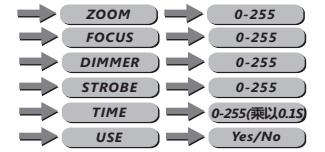

BASIC

CHANNEL	VALUE	FUNCTION
CH.1	0 ↔ 255	PAN (0-540°)
CH.2	0 ↔ 255	TITL (0-270°)
CH.3	0 ↔ 255	PAN/TILT SPEED (FROM FAST TO SLOW)
COLOR WHEEL 7+1		
	000 ↔ 007	WHITE
	008 ↔ 015	COLOR01
	016 ↔ 023	COLOR02
	024 ↔ 031	COLOR03
	032 ↔ 039	COLOR04
CH.4	040 ↔ 047	COLOR05
	048 ↔ 055	COLOR06
	056 ↔ 063	COLOR07
	064 ↔ 191	COLOR WHEEL 0-360°

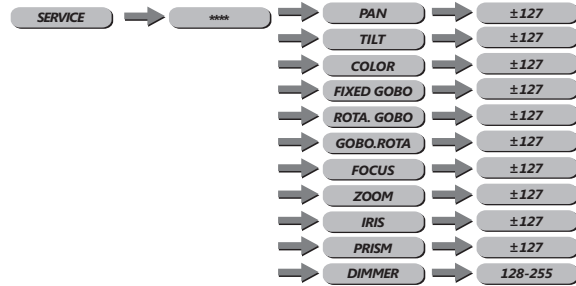

CHANNEL	VALUE	FUNCTION
	206 ↔ 255	PRISM INSERT AND REVERSE ROTATION (SPEED 1 → 100%)
	FROST LENS	
CH.12	0 ↔ 10	WHITE
	11 ↔ 251	FROST LENS (0-100%)
	252 ↔ 255	FROST LENS (100%)
	IRIS	
CH.13	0 ↔ 127	IRIS OPEN → CLOSE (FROM LARGE TO SMALL)
	128 ↔ 130	IRIS CLOSE
	131 ↔ 171	IRIS FAST IN FAST OUT (SPEED 1 → 100%)
	172 ↔ 211	IRIS FADE IN FADE OUT RANDOMLY (SPEED 1 → 100%)
	212 ↔ 251	IRIS FAST IN FADE OUT RANDOMLY (SPEED 1 → 100%)
	252 ↔ 255	IRIS CLOSE
CH.14	0 ↔ 255	ZOOM
	AUTO ZOOM	
CH.15	0 ↔ 1 2	NO FUNCTION
	13 ↔ 39	5M
	40 ↔ 66	7M
	67 ↔ 93	9M
	94 ↔ 120	11M
	121 ↔ 147	13M
	148 ↔ 174	15M
	175 ↔ 201	17M
	202 ↔ 228	19M
	229 ↔ 255	21M
CH.16	0 ↔ 255	MANUAL FOCUS
CH.17	0 ↔ 255	DIMMER
CH.18	0 ↔ 255	DIMMER FINE
	STROBE	
CH.19	0 ↔ 9	NO FUNCTION
	10 ↔ 99	STROBE (FROM SLOW TO FAST , 0-25Hz)
	100 ↔ 109	NO FUNCTION
	110 ↔ 179	LIGHTNING STROBE
	180 ↔ 189	NO FUNCTION
	190 ↔ 255	RANDOM STROBE
	CONTROL	
	000 ↔ 010	NO FUNCTION
	011 ↔ 020	PAN/TILT BLACK ACTIVATED
	021 ↔ 030	PAN/TILT BLACK DEACTIVATED
	031 ↔ 040	PAN INVERT

CHANNEL	VALUE	FUNCTION
	130 ↔ 136	FIXED GOBO WHEEL 8 SHAKE (SPEED 1 → 100%)
	137 ↔ 143	FIXED GOBO WHEEL 9 SHAKE (SPEED 1 → 100%)
	144 ↔ 150	FIXED GOBO WHEEL 10 SHAKE (SPEED 1 → 100%)
	151 ↔ 200	STATIC GOBO JUMPING WATER EFFECT (SPEED 100 → 1%)
	201 ↔ 205	STOP WATER EFFECT
	206 ↔ 255	STATIC GOBO FLOWING WATER EFFECT (SPEED 1 → 100%)
ROTATING GOBO		
	000 ↔ 010	WHITE
	011 ↔ 018	GOBO 1
	019 ↔ 026	GOBO 2
	027 ↔ 034	GOBO 3
	035 ↔ 042	GOBO 4
	043 ↔ 050	GOBO 5
	051 ↔ 058	GOBO 6
	059 ↔ 066	GOBO 7
CH.9	067 ↔ 074	ROTATING GOBO 1 SHAKE (SPEED 1 → 100%)
	075 ↔ 082	ROTATING GOBO 2 SHAKE (SPEED 1 → 100%)
	083 ↔ 090	ROTATING GOBO 3 SHAKE (SPEED 1 → 100%)
	091 ↔ 098	ROTATING GOBO 4 SHAKE (SPEED 1 → 100%)
	099 ↔ 106	ROTATING GOBO 5 SHAKE (SPEED 1 → 100%)
	107 ↔ 114	ROTATING GOBO 6 SHAKE (SPEED 1 → 100%)
	115 ↔ 122	ROTATING GOBO 7 SHAKE (SPEED 1 → 100%)
	123 ↔ 127	WHITE
	128 ↔ 190	ROTATING GOBO FLOWING WATER EFFECT (SPEED 100 → 1%)
	191 ↔ 192	STOP WATER EFFECT
	193 ↔ 255	ROTATING GOBO FLOWING WATER EFFECT (SPEED 1 → 100%)
GOBO ROTATING		
	0 ↔ 120	ROTATING GOBO ANGLE ADJUSTMENT (0 → 360°)
	121 ↔ 125	STOP
	126 ↔ 165	ROTATING GOBO SHAKE (SPEED 1 → 100%)
CH.10	166 ↔ 170	STOP
	171 ↔ 210	ROTATING GOBO POSITIVE ROTATION (SPEED 100% → 1)
	211 ↔ 215	STOP
	216 ↔ 255	ROTATING GOBO REVERSE ROTATION (SPEED 1 → 100%)
PRISM		
	0 ↔ 10	WHITE
	11 ↔ 145	PRISM INSERT AND ADJUST THE ANGLE (0 → 360°)
	146 ↔ 150	STOP
CH.11	151 ↔ 200	PRISM INSERT AND POSITIVE ROTATION (SPEED 100% → 1)
	201 ↔ 205	STOP ROTATION

3.3 DMX Address



- Enter the **【DMX】** mode to set the DMX address.
Enter UP/DOWN select **【1~512】** address.
Enter **【MENU】** return.

3.4 Personality(Person)



- Enter the **【PERSON】** mode to select DMX mode: **【STANDRAD】** , **【BASIC】** .

3.5 Runmode



- **【RUNMODE】** menu, select required run mode, there are six modes inside: **【DMX512】** DMX512 mode, **【AUTO】** auto run mode, **【CUSTOM1】** customer self-editing scene mode1, **【CUSTOM2】** customer self-editing scene mode2 press **【DOWN】** / **【UP】** select mode, press **【ENTER】** accept, press **【MENU】** return.

3.6 Performance(Option)

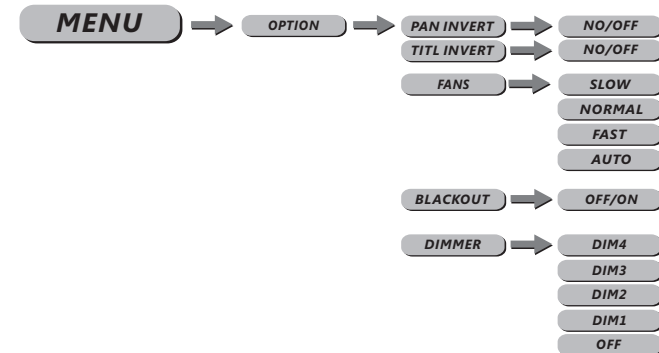

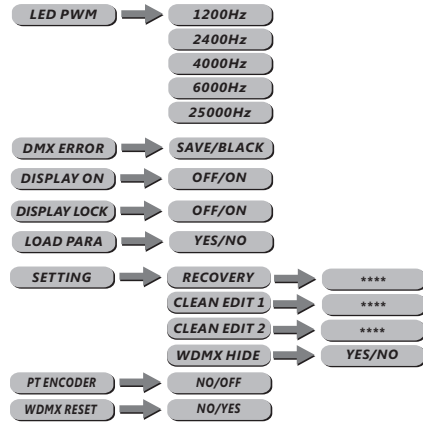

- Enter **【OPTION】** into the machine set.
- **【PAN INVERT】** menu, select **【NORMAL】** for normal direction, select **【INVERT】** for inverted of the PAN direction.
- **【FANS】** menu, select **【Slow/Norm/Fast/Auto】** as required fan speed. Choose **【OFF】** and **【ON】** to close and open the **【BLACKOUT】** mode.
- **【DIMMER】** menu for selection of **【DIM1/DIM2/DIM3/DIM4/OFF】** special dimming curves.
- **【LED PWM】** is PWM refresh rate bottom, press UP/DOWN to choose <1200Hz>, <2000Hz>, <2400Hz>, <6000Hz>, <25000Hz>; Attention: the gray level of dimming will be reduced as the refresh rate increases.
- **【DMX ERROR】** menu, select **【SAVE】** to maintain last command in case of DMX error or for blackout.
- Choose **【OFF】** and **【ON】** to close and open the display open & close mode in menu **【DISPLAY】**
- Choose **【OFF】** and **【ON】** to close and open the screen lock mode in menu **【DISPLAY LOCK】**
- **【LOAD PARA】** is parameter upload Settings, enter **【NO】** do not upload, enter **【YES】** upload.
- **【SETTING】** maintain settings, select **【RECOVERY】** is restore default factory settings. press **【ENTER】** enter password then press **【ENTER】**, if your password correct there will display **【OK】**.
- **【CLEAN EDIT1】** clean customer self-editing scene 1, press **【ENTER】** confirm.
- **【CLEAN EDIT2】** clean customer self-editing scene 2, press **【ENTER】** confirm.

STANDARD

CHANNEL	VALUE	FUNCTION
CH.1	0 ⇔ 255	PAN (0-540°)
CH.2	0 ⇔ 255	PAN FINE (FINE CONTROL OF PAN MOVEMENT 0-3°)
CH.3	0 ⇔ 255	TITL (0-270°)
CH.4	0 ⇔ 255	TILT FINE (FINE CONTROL OF TILT MOVEMENT 0-3°)
CH.5	0 ⇔ 255	PAN/TILT SPEED (FROM FAST TO SLOW)
COLOR WHEEL 7+1		
	000 ⇔ 007	WHTIE
	008 ⇔ 015	COLOR01
	016 ⇔ 023	COLOR02
	024 ⇔ 031	COLOR03
	032 ⇔ 039	COLOR04
	040 ⇔ 047	COLOR05
CH.6	048 ⇔ 055	COLOR06
	056 ⇔ 063	COLOR07
	064 ⇔ 191	COLOR WHEEL 0-360°
	192 ⇔ 222	COLOR WHEEL RAINBOW EFFECT (SPEED 100%->1)
	223 ⇔ 224	STOP
	225 ⇔ 255	COLOR WHEEL RAINBOW EFFECT (SPEED 1-> 100%)
CH.7	000 ⇔ 255	COLOR WHEEL FINE ADJUSTMENT.
FIXED GOBO WHEEL		
	0 ⇔ 10	WHITE
	11 ⇔ 17	FIXED GOBO WHEEL 1
	18 ⇔ 24	FIXED GOBO WHEEL 2
	25 ⇔ 31	FIXED GOBO WHEEL 3
	32 ⇔ 38	FIXED GOBO WHEEL 4
	39 ⇔ 45	FIXED GOBO WHEEL 5
	46 ⇔ 52	FIXED GOBO WHEEL 6
	53 ⇔ 59	FIXED GOBO WHEEL 7
	60 ⇔ 66	FIXED GOBO WHEEL 8
	67 ⇔ 73	FIXED GOBO WHEEL 9
	74 ⇔ 80	FIXED GOBO WHEEL 10
	81 ⇔ 87	FIXED GOBO WHEEL 1 SHAKE (SPEED 1 → 100%)
CH.8	88 ⇔ 94	FIXED GOBO WHEEL2 SHAKE (SPEED 1 → 100%)
	95 ⇔ 101	FIXED GOBO WHEEL 3 SHAKE (SPEED 1 → 100%)
	102 ⇔ 108	FIXED GOBO WHEEL 4 SHAKE (SPEED 1 → 100%)
	109 ⇔ 115	FIXED GOBO WHEEL 5 SHAKE (SPEED 1 → 100%)
	116 ⇔ 122	FIXED GOBO WHEEL 6 SHAKE (SPEED 1 → 100%)
	123 ⇔ 129	FIXED GOBO WHEEL 7 SHAKE (SPEED 1 → 100%)

3.10 Service

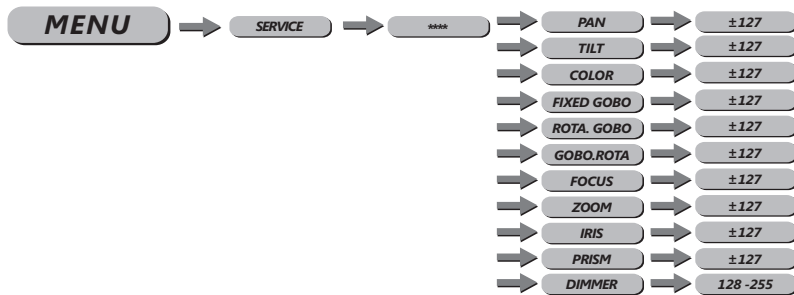

- Press **【ENTER】** into **【SERVICE】** enter password to enter the options page.
- **【PAN】** Pan position fine adjustment, push up and down buttons adjust ± 127 value.
- **【TILT】** tilt position fine adjustment, push up and down buttons adjust ± 127 value.
- **【COLOR】** color position fine adjustment, Push up and down buttons adjust ± 127 value.
- **【FIXED GOBO】** fix gobo position fine adjustment, Push up and down buttons adjust ± 127 value.
- **【ROTA. GOBO】** rotation gobo position fine adjustment, Push up and down buttons adjust ± 127 value.
- **【GOBO.ROTA】** gobo self-rotation position fine adjustment, Push up and down buttons adjust ± 127 value.
- **【FOCUS】** focus position fine adjustment, Push up and down buttons adjust ± 127 value.
- **【ZOOM】** zoom position fine adjustment, Push up and down buttons adjust ± 127 value.
- **【IRIS】** iris position fine adjustment, Push up and down buttons adjust ± 127 value.
- **【PRISM】** prism position fine adjustment, Push up and down buttons adjust ± 127 value.
- **【DIMMER】** is a dimming setting that limits the maximum brightness, range of values is 128~255 the lower the value, the higher the limit, 255 is unlimited.

4 Using a DMX512 Controller

4.1 Channel Assignment

- ◆ Note: this product have two DMX512 channel configuration: **【STANDARD】**, **【BASIC】**.

- **【WDMX HIDE】** hide wireless mode, WDMX RESET and SIGNAL hide and the default is wired mode only.
- **【PT ENCODER】** XY encoder switch, **【OFF】** is close, **【ON】** is open. **【WDMX RESET】** wireless resetting, use for patch wireless signal, **【YES】** is clear the receiver's message, press again patch wireless signal, **【No】** do not clear the receiver's message.

3.7 Edit

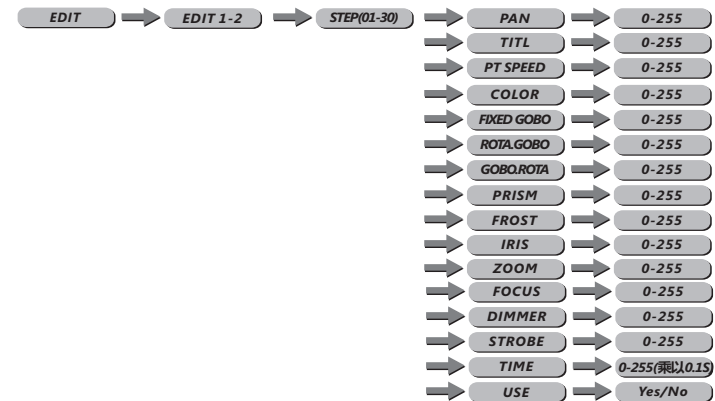

- Enter the **【EDIT】** mode to edit the custom programs by adjusting the value of **【PAN】**, **【TILT】**, **【PT SPEED】**, **【COLOR】**, **【FIXED GOBO】**, **【ROTA.GOBO】**, **【GOBO.ROTA】**, **【PRISM】**, **【FROST】**, **【IRIS】**, **【ZOOM】**, **【FOCUS】**, **【DIMMER】**, **【STROBE】**, **【TIME】**.
- Enter **【Use】** and select **【Yes】** to run the steps user need.

3.8 Manual control mode

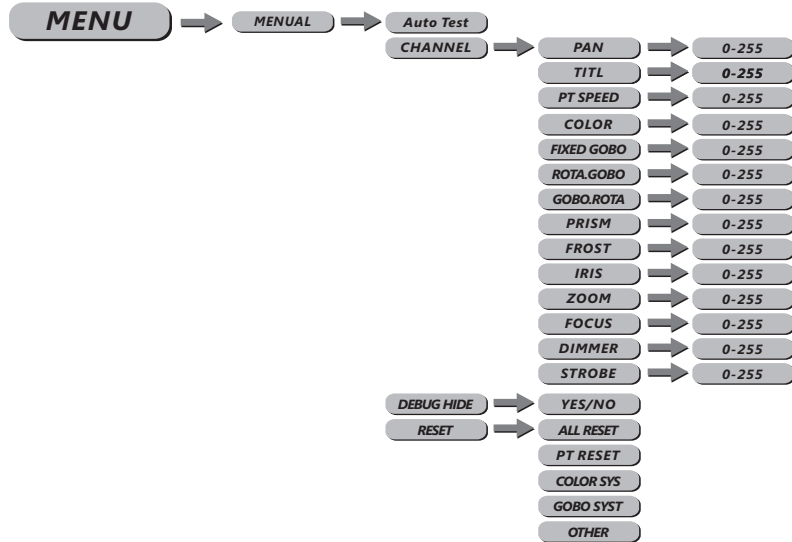

- Press **[ENTER]** into **[AUTOTEST]** at **[MENUAL]** .
- **[PAN]** pan set, **[TILT]** tilt set, **[PT SPEED]** set the pan & tilt speed, **[CT0]** Color wheel set, **[COLOR]** color temperature, **[FIXED GOBO]** set the static gobo wheel
[ROTA.GOBO] set the rotating gobo wheel, **[GOBO.ROTA]** set the autogiration of gobo wheel, **[PRISM]** set the prism, **[FROST]** set the frost lens, **[IRIS]** set the iris, **[ZOOM]** set the zoom of fixture, **[FOCUS]** set the focusing, **[DIMMER]** set the dimmer, **[STROBE]** set the strobe, push the UP/DOWN to set the value **[000~255]** .
[DEBUG HIDE] is the factory testing mode. All stepper motors are not controlled by signal, it only works again after the reset. enter **[NO]** out、enter **[YES]** in.
- **[RESET]** set the reset:
[ALL RESET] menu, select **[YES/NO]** to carry out all reset.
[PT RESET] menu, select **[YES/NO]** to carry out PAN/TILT reset.
[OTHER] focus、 zoom、 prism、 frost、 iris、 press **[NO]** do not resetting, press **[YES]** resetting.
[GOBO SYST] fix gobo resetting. press **[NO]** do not resetting, press **[YES]** resetting.

3.9 Info

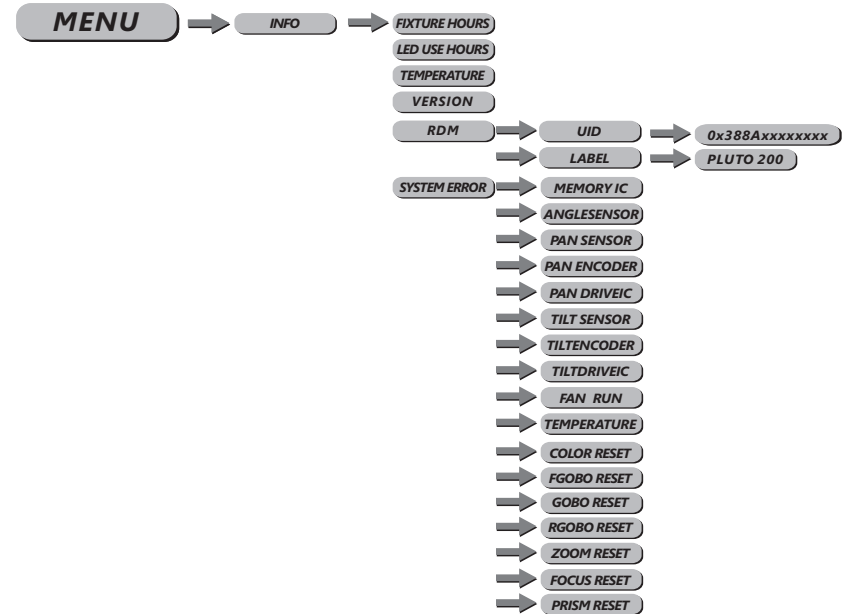

- Press **[ENTER]** into **[INFO]** check information, press up and down
- **[FIXTURE HOURS]** is hours of fixture use;
- **[LED USE HOURS]** is LED use time;
- **[TEMPERATURE]** is led temperature.
- **[VERSION]** is software versions;
- **[RDM]** check fixture's ID;
- **[SYSTEM ERROR]** system information error: Memory IC, Angle Sensor, PanSensor, Pan Encoder, Pan Drive IC, Tilt Sensor, TiltEncoder, TiltDriveIC, FAN RUN, Temperature, Color Reset, FGobo Reset, Gobo Reset, RGobo Reset, Zoom Reset, Focus Reset, Prism Reset.