

2000 Series Professional UHF Wireless Systems

ATW-2110 UniPak™ Transmitter System

ATW-2120 Handheld Dynamic Microphone System

Installation and Operation

Professional UHF Wireless Systems

Installation and Operation

This device complies with part 15 of the FCC Rules. Operation is subject to the condition that this device does not cause harmful interference.

This device complies with INDUSTRY CANADA R.S.S. 210, en conformité avec IC: RSS-210/CNR210. Operation is subject to the following conditions: 1) This device may not cause harmful interference and 2) this device must accept any interference received, including interference which may cause undesired operation.

CAUTION! Electrical shock can result from removal of the receiver cover. Refer servicing to qualified service personnel. No user-serviceable parts inside. Do not expose to rain or moisture.

The circuits inside the receiver and transmitter have been precisely adjusted for optimum performance and compliance with federal regulations. Do not attempt to open the receiver or transmitter. To do so will void the warranty, and may cause improper operation.

Notice to individuals *with implanted cardiac pacemakers or AICD devices:*

Any source of RF (radio frequency) energy *may* interfere with normal functioning of the implanted device. All wireless microphones have low-power transmitters (less than 0.05 watts output) which are unlikely to cause difficulty, especially if they are at least a few inches away. However, since a "body-pack" mic transmitter typically is placed against the body, we suggest attaching it at the belt, rather than in a shirt pocket where it may be immediately adjacent to the medical device. Note also that *any medical-device disruption will cease when the RF transmitting source is turned off*. Please contact your physician or medical-device provider if you have any questions, or experience any problems with the use of this or any other RF equipment.

Introduction

Thank you for choosing an Audio-Technica professional wireless system. You have joined thousands of other satisfied customers who have chosen our products because of their quality, performance and reliability. This Audio-Technica wireless microphone system is the successful result of years of design and manufacturing experience.

Each 2000 Series wireless system provides a choice of 10 PLL-synthesized UHF frequencies in the 656-678 MHz band (TV channels 45-48). Each wireless system includes a receiver and either a body-pack or handheld transmitter. Individual components are also available separately.

The ATW-R2100 receiver features true diversity reception. Two antennas feed two completely independent RF sections on the same frequency; automatic logic circuitry continuously compares and selects the superior received signal, providing better sound quality and reducing the possibility of interference and dropouts. Soft-touch controls provide convenient access to selection of operating frequency and automatic scanning, while an LCD information display provides constant monitoring of system operation. The receiver is half-width for a standard 1U 19" rack mount; rack-mount adapters are included. Two receivers can be mounted side by side, using an optional AT8630 joining-plate kit.

The versatile ATW-T210 UniPak™ body-pack transmitter has both low- and high-impedance inputs plus a bias connection, for use with dynamic and electret condenser microphones, as well as Hi-Z instrument pickups.

The ATW-T220 handheld dynamic microphone/transmitter features the same element used in the PRO 41 dynamic handheld microphone created for professional live-sound venues.

Transmitters in the 2000 Series use two 1.5V AA batteries for economical operation and wide availability. Both transmitters have battery condition indicators.

2000 Series receivers feature a sophisticated Tone Lock™ tone squelch system that opens the receiver's audio output only when a 2000 Series transmitter is detected, reducing the possibility of interference. As a result, 2000 Series transmitters and receivers must be used together and should not be used with components from other Audio-Technica wireless systems, or with those of other manufacturers.

Please note that in multiple-system applications there must be a transmitter-receiver combination set to a separate channel (frequency) for each input desired (only one transmitter for each receiver).

Because the wireless frequencies are within UHF TV frequency bands, only certain channels (operating frequencies) may be useable in a particular geographic area. The 10 channels (operating frequencies) that are used in the 2000 Series have been selected for multi-channel compatibility. Subject to frequency availability in a particular geographic area, any of these 10 channels may be used together.

The operating frequencies that correspond to each of the 10 channels are listed on page 11.

Receiver Installation

Location

For best operation the receiver should be at least 3 ft. (1 m) above the ground and at least 3 ft. away from a wall or metal surface to minimize reflections. The transmitter should be at least 3 ft. from the receiver, as shown in Figure A. Keep antennas away from noise sources such as digital equipment, motors, automobiles and neon lights, as well as away from large metal objects.

Output Connections

There are two audio outputs on the back panel: balanced (12.5 mV) and unbalanced (25 mV). Use shielded audio cable for the connection between the receiver and the mixer. If the input of the mixer is a $\frac{1}{4}$ " jack, connect a cable from the $\frac{1}{4}$ " unbalanced audio output on the back of the receiver housing to the mixer. If the input of the mixer is an XLR-type input, connect a cable from the balanced XLR-type audio output on the back panel to the mixer. The two isolated audio outputs permit simultaneous feeds to both unbalanced and balanced inputs. For example, both a guitar amp and a mixer can be driven by the receiver.

Figure A

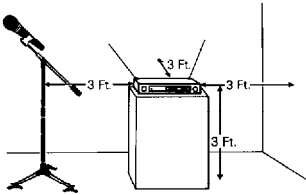

Antennas

Attach the included pair of UHF antennas to the antenna input jacks. The antennas are normally positioned in the shape of a "V" (both 45° from vertical) for best reception.

Accessory antennas can be remotely located from the receiver. However, due to signal loss in cables at UHF frequencies, use the lowest-loss RF cables practical for any cable runs over 25 feet. RG8-type is a good choice. Use only copper-shielded cable, not CATV-type foil-shielded wire. Audio-Technica offers quality RF cables in four lengths, as well as remote antennas; see the Optional System Accessories section on page 10.

Power Connections

Connect the included AC adapter to the DC power input on the back of the receiver. Loop the small cord from the DC plug over the cord hook above the jack, to keep the plug from being detached by an accidental tug on the cord. Then plug the adapter into a standard 120 Volt 60 Hz AC power outlet. Operation of the receiver is controlled by the front-panel Power switch.

(Note: Units supplied to countries with 230V mains should include an in-line AC adapter appropriate for that country.

Use the included adapter only with 120V 60 Hz AC power sources.)

Figure B-Front Panel Controls and Functions

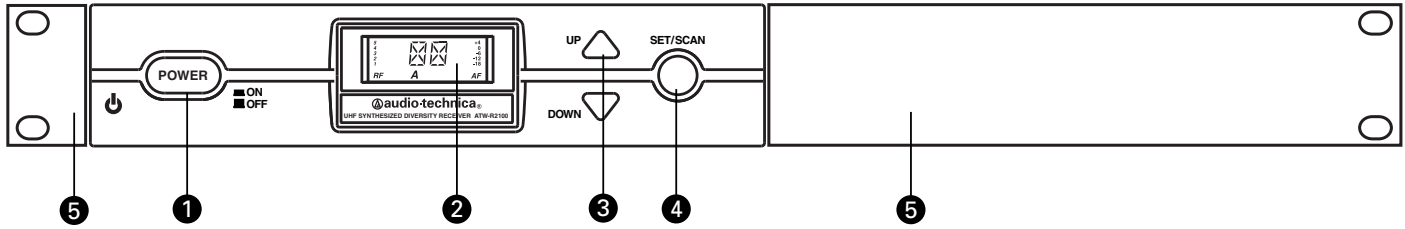

1. **POWER SWITCH:** Press the Power switch in to turn the receiver on. The LCD window will light, and the operating channel number will be displayed in the window. To turn the receiver off, press the Power switch again.
2. **LCD WINDOW:** Liquid Crystal Display indicates channel setting and operational readings. See Fig. C for examples.
3. **UP/DOWN BUTTONS:** Press Up or Down arrow buttons to arrive at desired channel. The selected number will flash on and off. Press and hold Set/Scan button to set the channel (operating frequency).
4. **SET/SCAN BUTTON:** Two distinct operations are associated with this button:
Touch: A momentary press of the Set/Scan button.
Hold: A press and hold (about two seconds) of the Set/Scan button.
 The Set/Scan button can be used in two ways: Manual Set Mode, to permit selection of an operating channel; and Automatic Scan/Set Mode, to initiate the automatic channel scan and selection, as follows:
Manual Set Mode: After using the Up or Down arrow button to arrive at desired channel, hold the Set/Scan button to set the channel. NOTE: Before the channel has been set, a touch of the Set/Scan button will revert the channel to its previous setting.
Automatic Scan/Set Mode: Hold the Set/Scan button. The Automatic Scan/Set Mode will automatically scan for and set the next open channel.
5. **MOUNTING ADAPTERS:** For mounting the receiver in any standard 19" rack. Attach adapters to the receiver with the screws supplied and remove the four receiver feet. (Use optional AT8630 joining-plate kit to mount two ATW-R2100 receivers side-by-side.)

Figure C-Receiver LCD Window Display

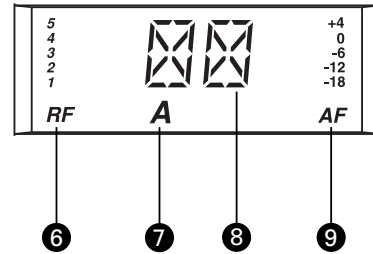

6. **RF SIGNAL LEVEL INDICATOR:** Shows the strength of the RF signal received from the transmitter.
7. **TUNER OPERATION INDICATOR:** Indicates which Tuner (A or B) has the better reception and is in operation.
8. **CHANNEL DISPLAY:** Shows which channel is selected.
9. **AF LEVEL INDICATOR:** Shows the audio modulation level of the received signal.

Figure D-Rear Panel Controls and Functions

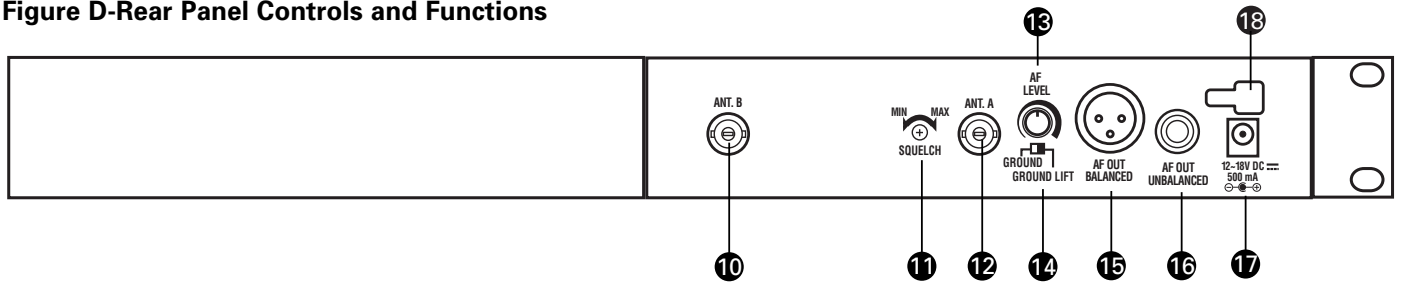

10. ANTENNA INPUT JACK: BNC-type antenna connector for Tuner "B." Attach the antenna directly, or extend it with a low-loss antenna cable. See the "Antennas" section on page 3 for more details.
11. SQUELCH CONTROL: Adjusts level of noise-muting circuit (preset at factory but can be adjusted as circumstances warrant). Factory setting is full counterclockwise.
12. ANTENNA INPUT JACK: Input for Tuner "A." Attach the supplied antenna directly, or extend it to an accessory antenna with a low-loss antenna cable.
13. AF LEVEL CONTROL: Adjusts audio output level of both AF output jacks; maximum output is fully clockwise.
14. GROUND LIFT SWITCH: Disconnects the ground pin of the balanced output jack (15) from ground. Normally, the switch should be to the left (ground connected). If hum caused by a ground loop occurs, slide switch to the right (ground lifted).
15. BALANCED AUDIO OUTPUT JACK: XLRM-type connector. A standard 2-conductor shielded cable can be used to connect the receiver output to a balanced microphone-level input on a mixer or integrated amplifier.
16. UNBALANCED AUDIO OUTPUT JACK: 1/4" phone jack. Can be connected to an unbalanced aux-level input of a mixer, guitar amp or tape recorder.
17. POWER INPUT JACK: Connect the DC plug from the included in-line AC adapter.
18. CORD HOOK: Loop the small DC cord around the cord hook to keep the DC plug from pulling out accidentally.

Transmitter Controls And Functions

Battery Selection

Two 1.5V AA alkaline batteries are recommended.

UniPak™ Transmitter Battery Installation

1. Open the transmitter door by pressing gently on the side-cover indentations and pulling back the hinged cover shown in Fig. E below.
2. Lift the battery-keeper arm, and carefully insert two fresh 1.5V AA alkaline batteries, observing correct polarity as marked inside the battery compartment.
3. Close the battery-keeper arm.
4. Close the transmitter door.

Figure E-UniPak Transmitter Open

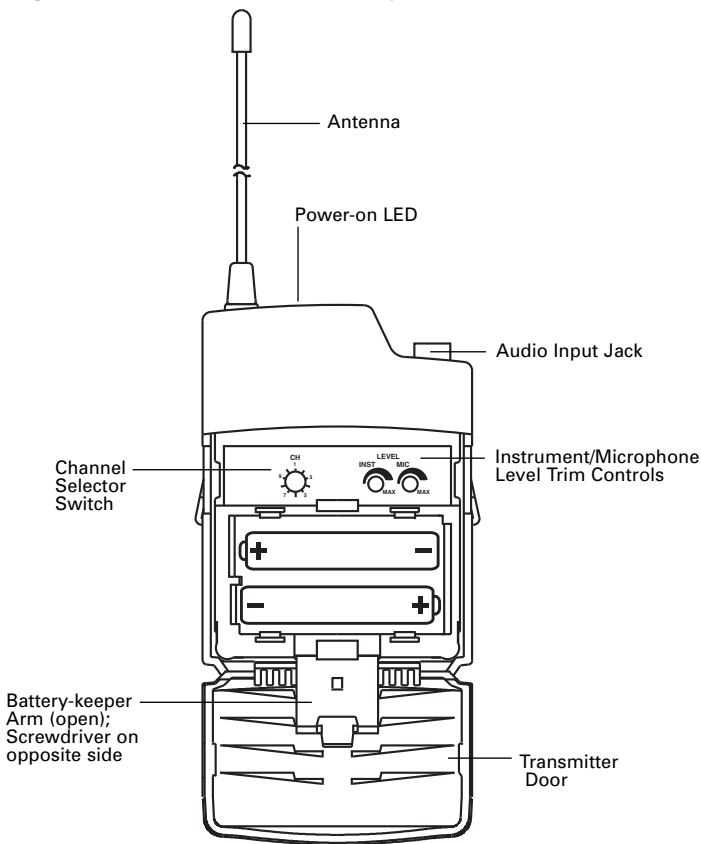

Handheld Transmitter Battery Installation

1. While holding the upper part of the transmitter body by the translucent ring below the ball-screen, unscrew the lower body cover, slide it downward, and remove it to expose the battery compartment.
2. Observe correct polarity as marked inside the battery compartment and carefully insert two fresh 1.5V AA alkaline batteries. Insert the first battery and slide it down. Then insert the second battery into the space remaining. Make certain the batteries are fully seated in the battery compartment. (Fig. F)
3. Slide the lower body cover back up the body, then screw the housing together. Do not over-tighten.

Note: Remove batteries from the handheld transmitter starting at the bottom end, where finger indents in the battery housing are provided for easy grip.

Figure F-Handheld Transmitter Battery Compartment

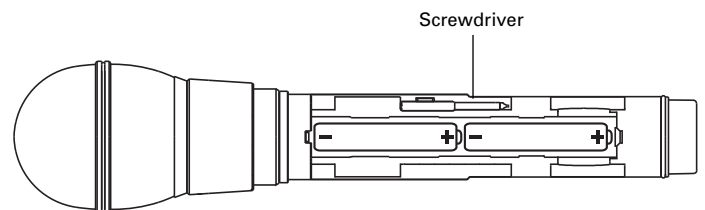

Battery Indicator

After the battery is installed, turn on the power switch (located on the bottom of the handheld transmitter and on the top of the UniPak transmitter). The battery indicator LED (Fig. G/H) should turn red. If it does not, the batteries are installed incorrectly or they are dead.

Figure G-UniPak Transmitter Top View

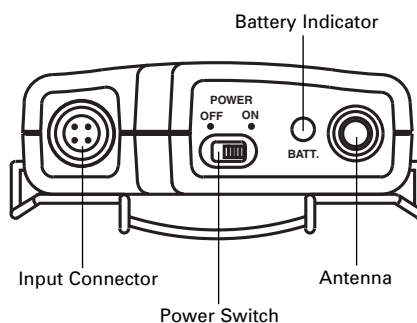
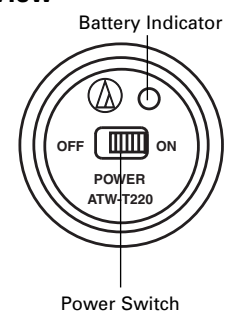

Figure H-Handheld Transmitter Bottom View



UniPak Transmitter Input Connection

Connect an audio input device (microphone or guitar cable) to the audio input connector on the top of the transmitter. A number of Audio-Technica professional microphones and cables are available separately, pre-terminated with a UniPak input connector (see "Optional System Accessories" on page 10).

UniPak Transmitter Antenna

The ATW-T210 UHF transmitter includes one field-replaceable antenna mounted on the transmitter. The antenna simply screws into the transmitter's antenna fitting. Check the installed antenna occasionally to make certain it is snugly attached (only finger-tight). If the received signal is marginal, experiment with different transmitter positions on your body or instrument or try repositioning the receiver. **Do not attempt to modify the transmitting antenna. Replace it only with the same parts,** available from the Audio-Technica Service Department.

System Operation

Switch on the receiver. Do *not* switch on the transmitter yet.

Receiver On...

The LCD display will light up and one of the tuner operation indicator LCD segments (A or B) will light, even though the transmitter is not on. If two or more of the RF LCD segments light up at this point, there may be RF interference in the area. If this occurs, change operating channels (select another frequency).

How to Make Operating Channel Changes

Operating channel changes (frequency changes) may be made in two ways: manually and automatically.

To change channel manually

1. Use the Up/Down arrow buttons to reach the desired channel number.
2. Hold the Set/Scan button until the channel number stops flashing to set the receiver to the channel indicated.
NOTE: Before the channel has been set, a touch (momentary press) of the Set/Scan (rather than a hold) will revert the channel to its previous setting.

To change channel automatically

1. Hold the Set/Scan button. The Automatic Scan/Set Mode will automatically scan for and set the next open channel. LCD screen will flash "FS" four times to indicate start of scan.

Transmitter On...

Before turning on the transmitter, use the provided screwdriver to set the transmitter channel selector switches (Fig. E/I) to the same numbers as those displayed on the receiver. Always turn the transmitter off when changing channels (frequencies).

The transmitters have a two-position, on-off power switch. When the switch is "On," the transmitter produces both RF and audio.

There is about a half-second delay after the transmitter is switched to the "On" position before the receiver's Tone Lock squelch un-mutes the receiver.

When the transmitter is switched on and in normal operation, the receiver's RF signal level indicators will display as dark segments (signal strength indicators) from bottom to top at the left side of the LCD display.

Setting Levels

Correct adjustment of transmitter audio input, receiver audio output, and mixer/amplifier input and output levels is important for optimum system performance.

ATW-T220 Handheld Transmitter

The 2000 Series handheld transmitter has factory pre-set audio input levels. Factory setting is full clockwise, maximum gain.

While speaking/singing into the microphone at typically loud levels, check the AF meter levels on the receiver. If all five AF meter bars are consistently illuminated and distortion is heard through the system, it may be necessary to adjust the transmitter audio input level.

To adjust the transmitter audio input level, unscrew the lower body cover and slide it downwards, exposing the screwdriver and level trim control (Fig I). Remove the screwdriver and gently turn the level trim control counterclockwise until the topmost receiver AF level meter bar is illuminated only on audio peaks.

Return the screwdriver to its clip and close and secure the lower body. No further transmitter gain adjustments should be needed, as long as the acoustic input does not change significantly.

CAUTION! The small trimmer controls are delicate; use only the supplied screwdriver. Do not force the trimmers beyond their normal 180° range of rotation.

Return the screwdriver to its storage clip when not in use.

Figure I-Handheld Transmitter Interior View

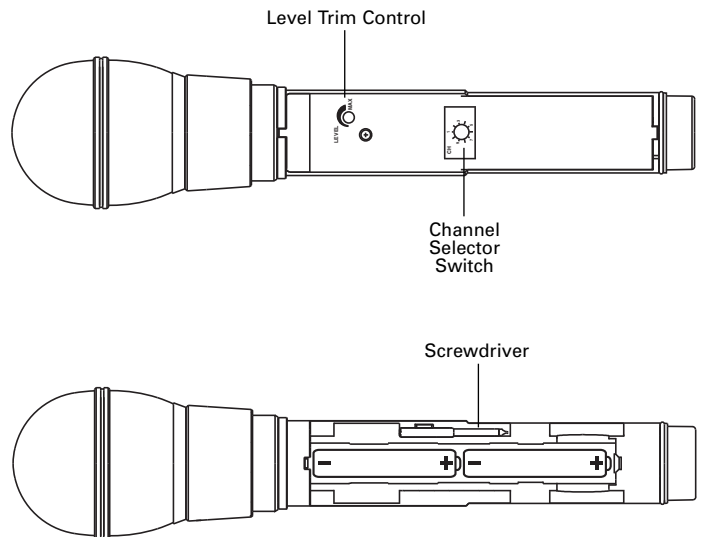

Setting Levels (Continued)

ATW-T210 UniPak™ Transmitter

Trimmer adjustments in the UniPak™ transmitter (Fig. E) will enable you to use microphones or instruments with different output levels.

1. For MIC: Set microphone level trim control fully clockwise (maximum) and instrument level trim control fully counterclockwise (minimum).

For INSTRUMENT: Set instrument level trim control fully clockwise (maximum) and microphone level trim control fully counterclockwise (minimum).
2. Set the receiver's AF Level control to its full clockwise position (maximum). See Figure D on page 5.
3. Plug the mic or instrument into the transmitter and power up the system.
4. For MIC: Make an initial adjustment of the mixer's level controls that will allow audio through the system.

For INSTRUMENT: Make an initial adjustment of the instrument amplifier input level control that will allow audio through the system.
5. For MIC: While speaking/singing into the microphone at typically loud levels, check the AF meter levels on the receiver. If all five meter bars are consistently illuminated and distortion is heard through the system, it may be necessary to adjust the UniPak transmitter audio input level. To adjust the transmitter audio input level, gently turn the microphone level trim control counterclockwise until the topmost receiver AF level meter bar is illuminated only on audio peaks.

For INSTRUMENT: While playing the instrument at typically loud levels, check the AF meter levels on the receiver. If all five meter bars are consistently illuminated and distortion is heard through the system, it may be necessary to adjust the UniPak transmitter audio input level. To adjust the transmitter audio input level, gently turn the instrument level trim control counterclockwise until the topmost receiver AF level meter bar is illuminated only on audio peaks.

6. For MIC: While again speaking/singing into the microphone at typically loud levels, adjust the mixer's input trim control so the highest sound pressure level going into the microphone causes no input overload in the mixer, and yet permits the mixer's channel and output level controls to operate in their "normal" range (not set too high or too low).

For INSTRUMENT: While again playing the instrument at typically loud levels, adjust the receiver's AF Level control so the highest signal level causes no input overload in the instrument amplifier and yet permits the amplifier's input level controls to operate in their "normal" range (not set too high or too low).

Note: If the mixer cannot be adjusted to operate in its normal range without distortion, adjust the receiver's AF Level Control (turn counterclockwise) until the mixer/ amplifier is no longer overloaded.

Figure E-UniPak Transmitter Open

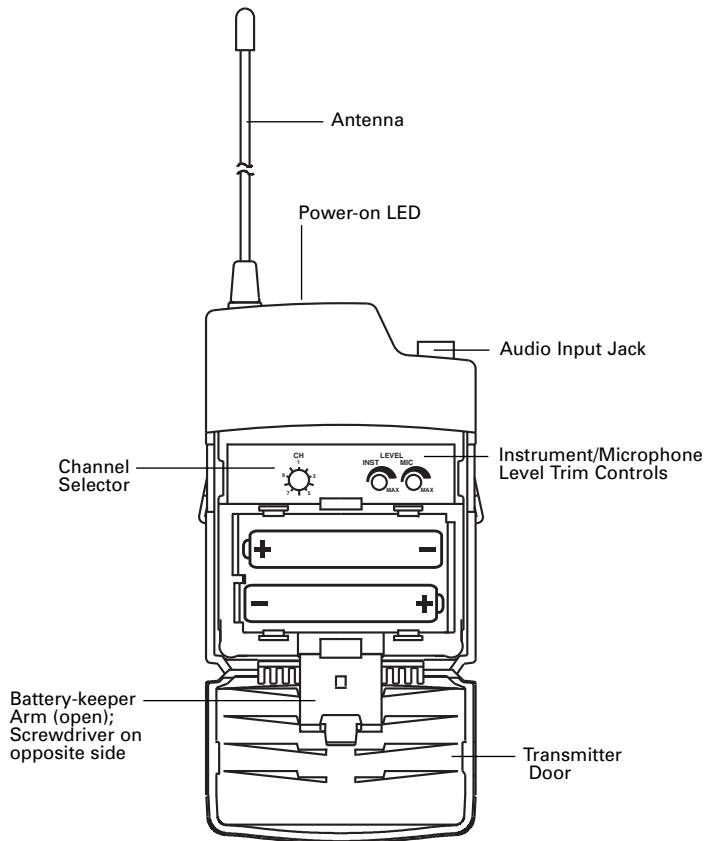

Receiver Squelch

The squelch control on the back panel of the receiver is preset at the factory for best system performance (factory setting is full counterclockwise), but can be adjusted if you must use the system in an area with considerable RF interference. If there is interference in the audio, and changing the channel is not an option, adjust the squelch control so the system will receive the signal from your transmitter but will "squelch" or eliminate the unwanted background RF noise. This adjustment can cause a reduction in useable range of the wireless transmitter, so set the control to the lowest position that reliably mutes the unwanted RF signals.

RF Interference

Specifications[†]

OVERALL SYSTEM

| | |
|-----------------------------|--|
| Operating Frequency | UHF band, 656.125 to 678.500 MHz |
| Number of Channels | 10 total |
| Frequency Stability | ±0.005%, Phase Lock Loop frequency control |
| Modulation Mode | FM |
| Normal Deviation | ±5 kHz |
| Operating Range | 300' typical |
| Operating Temperature Range | 41° F (5° C) to 113° F (45° C) |
| Frequency Response | 100 Hz to 15 kHz |

RECEIVER

| | |
|------------------------------------|---|
| Receiving System | Dual independent receivers, automatic-switching diversity |
| Image Rejection | 55 dB nominal, 50 dB minimum |
| Signal-to-noise Ratio | >100 dB at 40 kHz deviation (A-weighted), maximum modulation 40 kHz |
| Total Harmonic Distortion | <1% (±10 kHz deviation at 1 kHz) |
| Sensitivity | 20 dBµV (S/N 60 dB at 5 kHz deviation, IEC-weighted) |
| Intermediate Frequency | 65.75 MHz, 10.7 MHz |
| Audio Output (AF Level set at "0") | |
| Unbalanced: | 25 mV (at 1 kHz, ±5 kHz deviation, 100k ohm load) |
| Balanced: | 12.5 mV (at 1 kHz, ±5 kHz deviation, 100k ohm load) |
| Output Connectors | |
| Unbalanced: | 1/4" phone jack |
| Balanced: | XLRM-type |
| Power Supply | 120V AC 60 Hz, or 12-18V DC, 350 mA, with external supply |
| Dimensions | 8.27" (210.0 mm) W x 1.73" (44.0 mm) H x 6.39" (162.2 mm) D |
| Weight | 2.2 lbs (1.0 kgs) |
| Accessories Included | Two flexible UHF antennas, rack-mount adapters, AC adapter |

UNIPAK™ TRANSMITTER

| | |
|--------------------------------|---|
| RF Power Output | 12 mW |
| Spurious Emissions | Under federal regulations |
| Input Connections | High impedance, low impedance, bias |
| Batteries (not included) | Two 1.5V AA alkaline |
| Current Consumption | 150 mA typical |
| Battery Life | Approximately 9 hours (depending on battery type and use pattern) |
| Dimensions | 2.60" (66.0 mm) W x 3.63" (92.3 mm) H x 0.89" (22.5 mm) D |
| Net Weight (without batteries) | 2.82 oz (80 g) |

HANDHELD TRANSMITTERS

| | |
|--------------------------------|---|
| RF Power Output | 12 mW |
| Spurious Emissions | Under federal regulations |
| Microphone Element | Dynamic, unidirectional |
| Batteries (not included) | Two 1.5V AA alkaline |
| Current Consumption | 150 mA typical |
| Battery Life | Approximately 9 hours (depending on battery type and use pattern) |
| Dimensions | 9.02" (229.0 mm) long x 2.11" (53.5 mm) maximum diameter |
| Net Weight (without batteries) | 7.81 oz (221.5 g) |
| Accessory Included | AT8456a Quiet-Flex™ stand clamp |

[†] In the interest of standards development, A.T.U.S. offers full details on its test methods to other industry professionals on request. Specifications are subject to change without notice.

Optional System Accessories

WIRELESS ESSENTIALS™ MICROPHONES AND CABLES

| | |
|------------|--|
| AT829cW | Miniature cardioid condenser lavalier microphone. Includes clothing clip and windscreen. |
| MT830cW | Miniature omnidirectional condenser lavalier microphone. Includes clothing clip and windscreen. |
| MT830cW-TH | "Theater" model, same as MT830cW except beige color mic and cable for concealment. |
| AT831cW | Miniature cardioid condenser lavalier microphone. Includes clothing clip and windscreen. |
| AT889cW | Headworn noise-canceling condenser microphone. Includes windscreen and cable clip. |
| AT898cW | Subminiature cardioid condenser lavalier microphone. Includes clothing clip base, viper clip base, magnet clip base, three single mic holders, two double mic holders and two windscreens. |
| AT899cW | Subminiature omnidirectional condenser lavalier microphone. Includes AT899AK accessory kit. |
| AT899cW-TH | "Theater" model, same as AT899cW except beige color mic and cable concealment. Includes AT899AK-TH accessory kit. |
| ATM35cW | Cardioid condenser instrument microphone. Includes AT8418 clip-on instrument mount. |
| ATM73cW | Headworn cardioid condenser microphone. Includes windscreen. |
| ATM75cW | Headworn cardioid condenser microphone. Includes windscreen. |
| PRO8HEcW | Headworn hypercardioid dynamic microphone. Includes windscreen and cable clip. |
| PRO35xcW | Cardioid condenser instrument microphone. Includes AT8418 clip-on instrument mount. |
| AT-GCW | Hi-Z instrument/guitar cable with 1/4" phone plug. |
| XLRW | Connecting cable for UniPak transmitter with an XLR-type input connector, for Lo-Z microphones with XLRM-type output terminations. |

RECEIVER ACCESSORIES

| | | | | | | | | | |
|------------|--|------|-----------------------|------|----------------------|------|----------------------|-------|-----------------------|
| AEW-DA660D | UHF (655-680 MHz) active unity-gain antenna distribution system provides two "1-in, 4-out" RF channels; connects a pair of antennas to as many as four diversity receivers; cascade output provided as a directional coupler. AC pass-through allows daisy-chain AC hookup. Defeatable antenna power. Metal receiver chassis with reinforced mounting ears and rear rack mount capability. Includes detachable IEC power cable, IEC pass-through cable, ten RF cables, front-mount antenna cables and connectors, four DC power cables to power up to four 2000 Series receivers. Mounts in a single 19" rack space. | | | | | | | | |
| AT8630 | Joining-plate kit allows rack-mounting two ATW-R2100 receivers side-by-side in a single (1U) 19" rack space. | | | | | | | | |
| ATW-A20 | Pair of UHF ground-plane antennas with 5/8"-27 thread for mounting to microphone stands, etc. For use with ATW-R2100 receivers. Takes RF cables with BNC connectors, not included; see RF Cables below. | | | | | | | | |
| ATW-A49 | Pair of UHF wide-band directional LPDA (log periodic dipole array) antennas provide enhanced signal pickup for UHF wireless systems throughout a wide band range (440-900 MHz). Each antenna paddle is matched to 50 ohms impedance with intergral high-quality low-loss BNC connector; 6 dB gain. For permanent or temporary installation; mounts to 5/8"-27 threads. | | | | | | | | |
| ATW-RA1 | Rack-mount antenna kit brings antenna inputs to the front of receiver for ease of setup, or when receiver is enclosed in a metal rack. Includes a pair of extendible antennas. NOTE: Two adapter kits are required when mounting two receivers side-by-side in a single 19" rack space. | | | | | | | | |
| RF Cables | Low-loss design, 50 ohm impedance, with BNC-to-BNC connectors: <table style="margin-left: 20px;"> <tr> <td>AC12</td> <td>RG58-type cable (12')</td> </tr> <tr> <td>AC25</td> <td>RG8-type cable (25')</td> </tr> <tr> <td>AC50</td> <td>RG8-type cable (50')</td> </tr> <tr> <td>AC100</td> <td>RG8-type cable (100')</td> </tr> </table> | AC12 | RG58-type cable (12') | AC25 | RG8-type cable (25') | AC50 | RG8-type cable (50') | AC100 | RG8-type cable (100') |
| AC12 | RG58-type cable (12') | | | | | | | | |
| AC25 | RG8-type cable (25') | | | | | | | | |
| AC50 | RG8-type cable (50') | | | | | | | | |
| AC100 | RG8-type cable (100') | | | | | | | | |

TRANSMITTER ACCESSORIES

| | |
|---------|--|
| AT8114 | Foam windscreen for handheld transmitter. |
| AT8141 | Water-resistant pouch for UniPak transmitter. |
| AT8456a | Quiet-Flex™ stand clamp for handheld transmitter, 5/8"-27 threads. |

2000 Series Frequency Channel Plan

| Channel | Frequency - MHz | TV Channel |
|---------|-----------------|------------|
| 1 | 656.125 | 45 |
| 2 | 659.375 | |
| 3 | 660.000 | |
| 4 | 662.125 | 46 |
| 5 | 665.125 | |
| 6 | 669.750 | 47 |
| 7 | 671.500 | |
| 8 | 677.000 | 48 |
| 9 | 678.125 | |
| 10 | 678.500 | |

Note: All frequencies selected to avoid standard analog TV carrier interference.

Ten Tips to Obtain the Best Results

1. Use only fresh alkaline batteries. Do not use "general purpose" (carbon-zinc) batteries.
2. Position the receiver so that it has the fewest possible obstructions between it and the normal location of the transmitter. Line-of-sight is best.
3. The transmitter and the receiver should be as close together as conveniently possible, but no closer than three feet (1 m).
4. The receiver antennas should be in the open and away from any metal. If mounted in a rack, have the unit on top, or use an ATW-RA1 kit to front-mount the antennas.
5. The transmitter and receiver must be set to the same channel number.
6. A receiver cannot receive signals from two transmitters at the same time.
7. If the AF Level control of the receiver is set too high, it may over-drive the input of the mixer or clip the output of the receiver, causing distortion. Conversely, if the receiver output is set too low, the overall signal-to-noise ratio of the system may be reduced. Please see Setting Levels section, pages 7 and 8.
8. You need to change channels when a strong interference signal is received (a strong RF signal is shown with the transmitter off).
9. In the UniPak transmitter, the microphone level trim or instrument level trim input control not in use should be set to minimum.
10. Turn the transmitter off when not in use. Remove the battery if the transmitter is not to be used for a period of time.

For future reference, please record your system information here.

Receiver ATW-R2100 S/N _____
Serial Number appears on the FCC label on the back of the receiver.

UniPak™ Body-Pack Transmitter ATW-T210 S/N _____
Serial Number appears on the FCC label on the back of the transmitter.

Handheld Dynamic Microphone Transmitter ATW-T220 S/N _____
Serial Number appears on the FCC label on the interior of the transmitter.

One-Year Limited Warranty

Audio-Technica professional wireless systems purchased in the U.S.A. are warranted for one year from date of purchase by Audio-Technica U.S., Inc. (A.T.U.S.) to be free of defects in materials and workmanship. In event of such defect, product will be repaired promptly without charge or, at our option, replaced with a new product of equal or superior value if delivered to A.T.U.S. or an Authorized Service Center, prepaid, together with the sales slip or other proof of purchase date. **Prior approval from A.T.U.S. is required for return.** This warranty excludes defects due to normal wear, abuse, shipping damage, or failure to use product in accordance with the instructions. This warranty is void in the event of unauthorized repair or modification, or removal or defacing of the product labeling.

For return approval and shipping information, contact the Service Dept., Audio-Technica U.S., Inc., 1221 Commerce Drive, Stow, Ohio 44224.

Except to the extent precluded by applicable state law, **A.T.U.S. will have no liability for any consequential, incidental, or special damages; any warranty of merchantability or fitness for particular purpose expires when this warranty expires.**

This warranty gives you specific legal rights, and you may have other rights which vary from state to state.

Outside the U.S.A., please contact your local dealer for warranty details.

